

GENERAL CHARACTERISTICS

ELECTRICAL

Filament: Thoriated tungsten	
Voltage - - - - -	5.0 or 10.0 volts
Current - - - - -	12.5 or 6.25 amperes
Amplification Factor (Average) - - - - -	20
Direct Interelectrode Capacitances (Average)	
Grid-Plate - - - - -	4.8 $\mu\mu\text{f}$
Grid-Filament - - - - -	5.7 $\mu\mu\text{f}$
Plate-Filament - - - - -	0.8 $\mu\mu\text{f}$
Transconductance ($i_b = 500 \text{ ma.}$, $E_b = 3000 \text{ v.}$, $E_c = -40 \text{ v.}$)	8300 μmhos
Frequency for Maximum Ratings - - - - -	40 mc

MECHANICAL

Base - - - - -	Special 4 pin, No. 5000B
Basing - - - - -	RMA type 4BC
Maximum Overall Dimensions:	
Length - - - - -	7.625 inches
Diameter - - - - -	2.563 inches
Net weight - - - - -	7 ounces
Shipping weight (Average) - - - - -	2.0 pounds

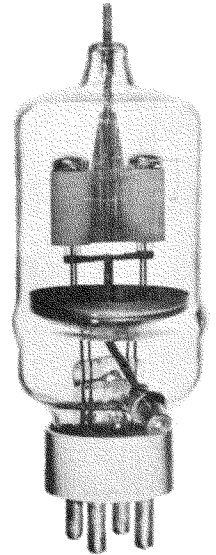

AUDIO FREQUENCY POWER AMPLIFIER AND MODULATOR

Class B

	TYPICAL OPERATION—2 TUBES			MAX. RATING
D-C Plate Voltage - - - - -	1500	2000	3000	3000 volts
Max.-Signal D-C Plate Current, per tube* - - -	•	•	•	450 ma.
Plate Dissipation, per tube* - - - - -	•	•	•	150 watts
D-C Grid Voltage (approx.) - - - - -	-65	-90	-150	volts
Peak A-F Grid Input Voltage - - - - -	340	350	430	volts
Zero-Signal D-C Plate Current - - - - -	133	100	67	ma.
Max.-Signal D-C Plate Current - - - - -	535	450	335	ma.
Max.-Signal Driving Power (approx.) - - - - -	9	6	3	watts
Effective Load, Plate-to-Plate - - - - -	5700	9600	20300	ohms
Max.-Signal Plate Power Output - - - - -	500	600	700	watts

*Averaged over any sinusoidal audio frequency cycle.

RADIO FREQUENCY POWER AMPLIFIER AND OSCILLATOR

Class-C *Telegraphy

(Key down conditions without modulation)

	TYPICAL OPERATION—1 TUBE			MAX. RATING
D-C Plate Voltage - - - - -	1500	2000	3000	3000 volts
D-C Plate Current - - - - -	333	300	250	450 ma.
D-C Grid Current - - - - -	58	74	70	85 ma.
D-C Grid Voltage - - - - -	-125	-200	-300	volts
Plate Power Output - - - - -	350	450	600	watts
Plate Input - - - - -	500	600	750	watts
Plate Dissipation - - - - -	150	150	150	150 watts
Peak R. F. Grid Input Voltage, (approx.) - - -	267	334	410	volts
Driving Power, (approx.) - - - - -	13	20	27	watts

*The above figures show actual measured tube performance, and do not allow for variations in circuit losses.

GRID VOLTAGE—VOLTS

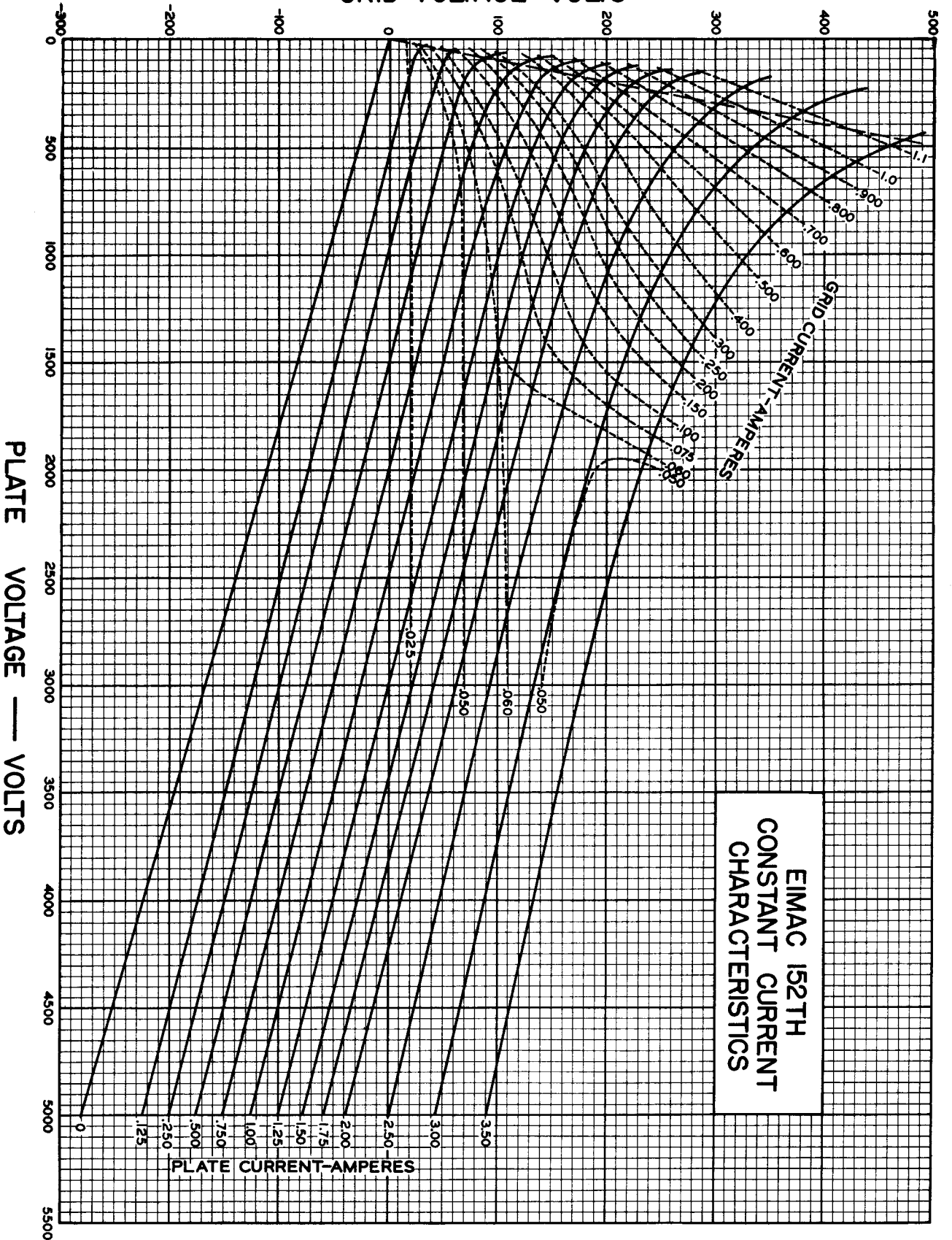

DRIVING POWER vs. POWER OUTPUT

The three charts on this page show the relationship of plate efficiency, power output and grid driving power at plate voltages of 1500, 2000 and 3000 volts. These charts show combined grid and bias losses only. The driving power and power output figures do not include circuit losses. The plate dissipation in watts is indicated by P_p .

Points A, B, and C are identical to the typical Class C operating conditions shown on the first page under 1500, 2000, and 3000 volts respectively.

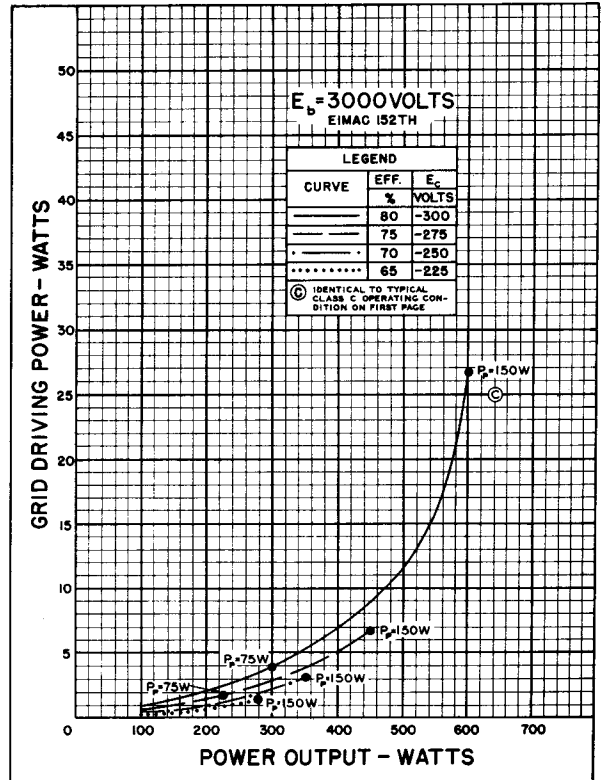
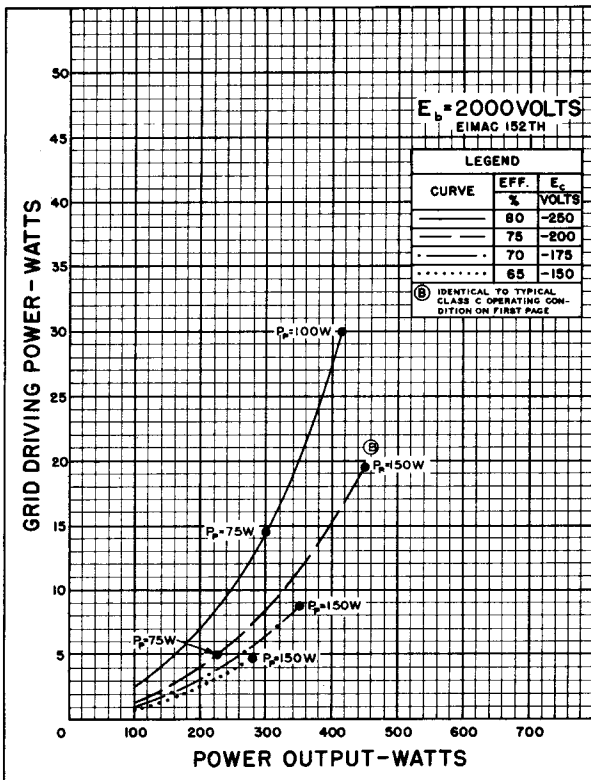
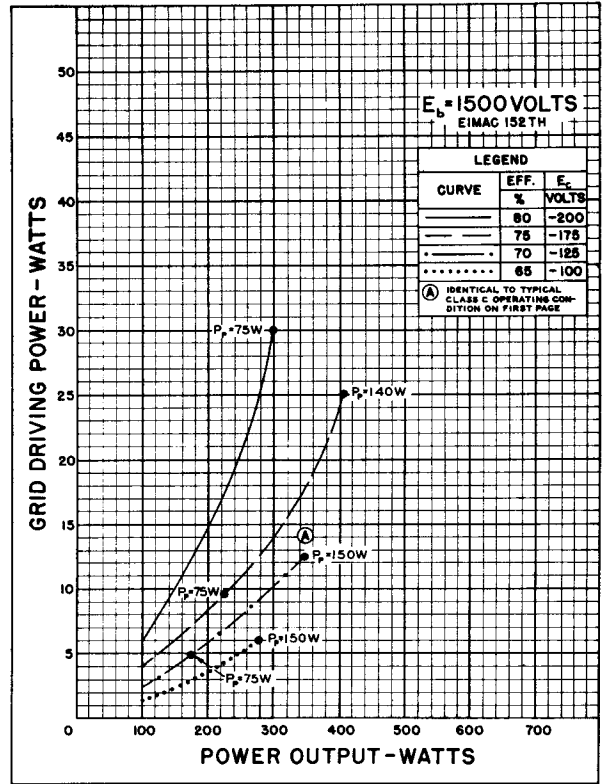

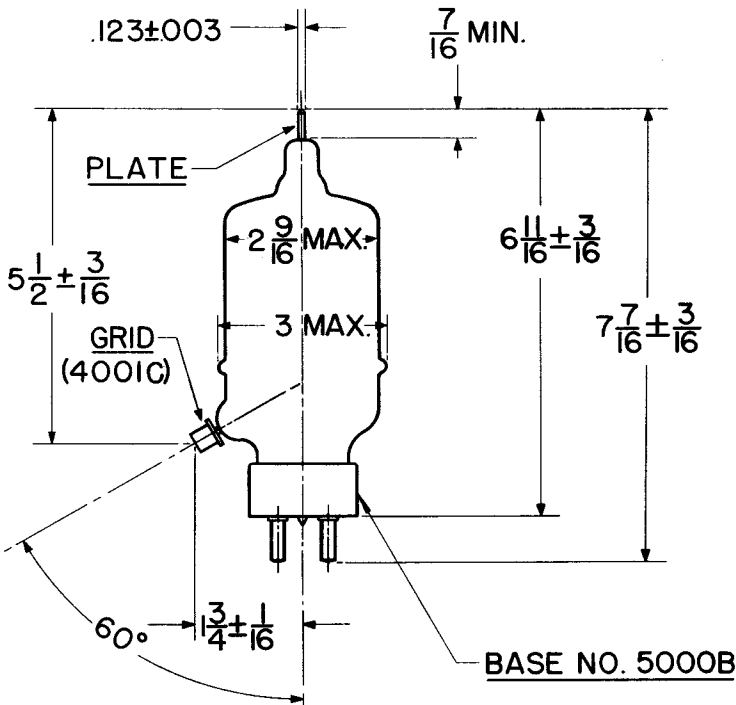
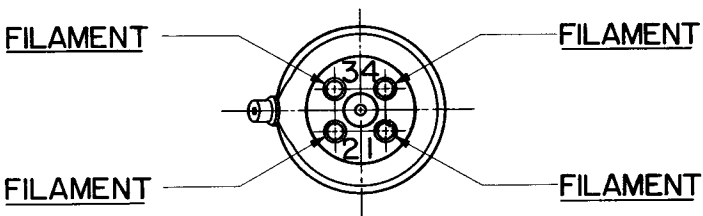
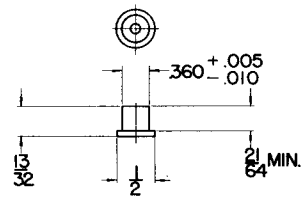
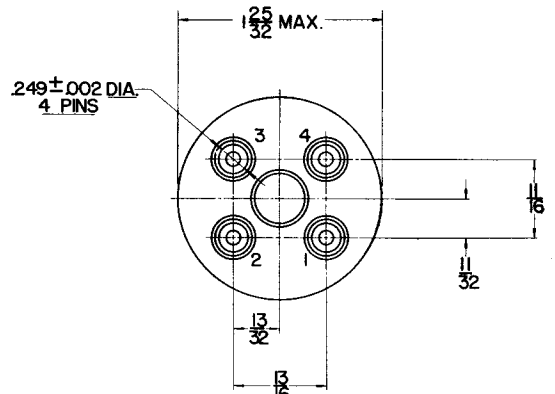
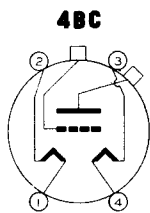
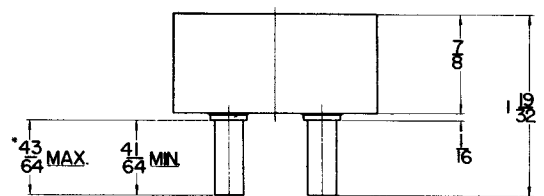

PLATE CAP
 (SEE TUBE OUTLINE DRAWING)

GRID CAP
 NO. 4001C



BASE NO. 5000B



*ON FINISHED TUBE ADD .060 FOR SOLDER