

Descriptions

- High current application
- Radio in class B push-pull operation

Feature

- Complementary pair with STS8050

Ordering Information

Type NO.	Marking	Package Code
STS8550	STS8550	TO-92

Outline Dimensions

unit : mm

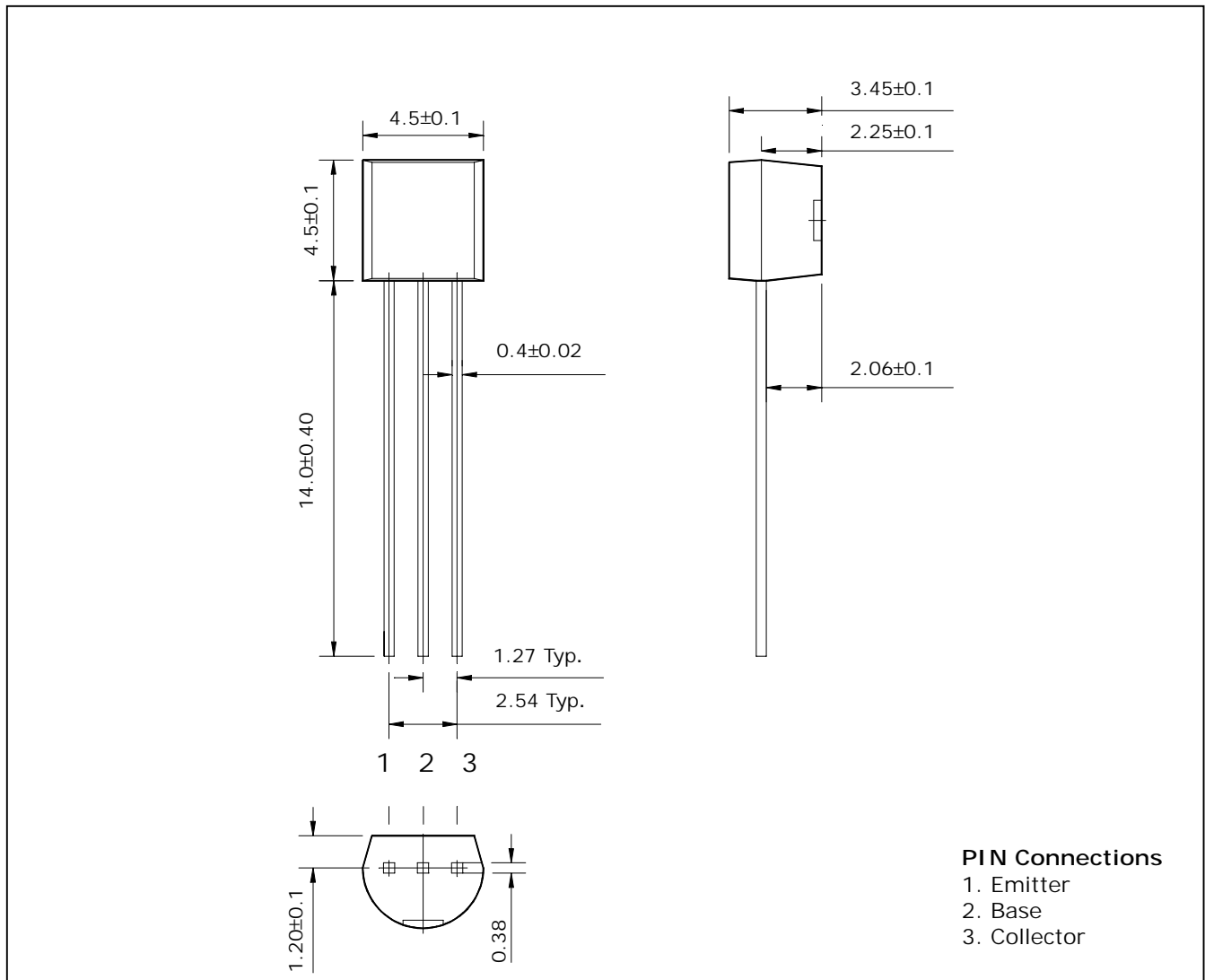

Absolute maximum ratings

(Ta=25°C)

Characteristic	Symbol	Ratings	Unit
Collector-Base voltage	V_{CBO}	-30	V
Collector-Emitter voltage	V_{CEO}	-25	V
Emitter-Base voltage	V_{EBO}	-6	V
Collector current	I_C	-800	mA
Emitter current	I_E	800	mA
Collector dissipation	P_C	625	mW
Junction temperature	T_j	150	°C
Storage temperature	T_{stg}	-55 ~ 150	°C

Electrical Characteristics

(Ta=25°C)

Characteristic	Symbol	Test Condition	Min.	Typ.	Max.	Unit
Collector-Base breakdown voltage	BV_{CBO}	$I_C = -500\mu A, I_E = 0$	-30	-	-	V
Collector-Emitter breakdown voltage	BV_{CEO}	$I_C = -1mA, I_B = 0$	-25	-	-	V
Collector cut-off current	I_{CBO}	$V_{CB} = -15V, I_E = 0$	-	-	-50	nA
DC current gain	h_{FE}^*	$V_{CE} = -1V, I_C = -50mA$	85	-	300	-
Collector-Emitter saturation voltage	$V_{CE(sat)}$	$I_C = -500mA, I_B = -50mA$	-	-	-0.5	V
Base-Emitter voltage	V_{BE}	$V_{CE} = -1V, I_C = -500mA$	-	-	-1.2	V
Transition frequency	f_T	$V_{CE} = -5V, I_C = -10mA$	-	120	-	MHz
Collector output capacitance	C_{ob}	$V_{CB} = -10V, I_E = 0, f = 1MHz$	-	19	-	pF

* : h_{FE} Rank / B : 85~160, C : 120~200, D : 160~300

Electrical Characteristic Curves

Fig. 1 $P_c - T_a$

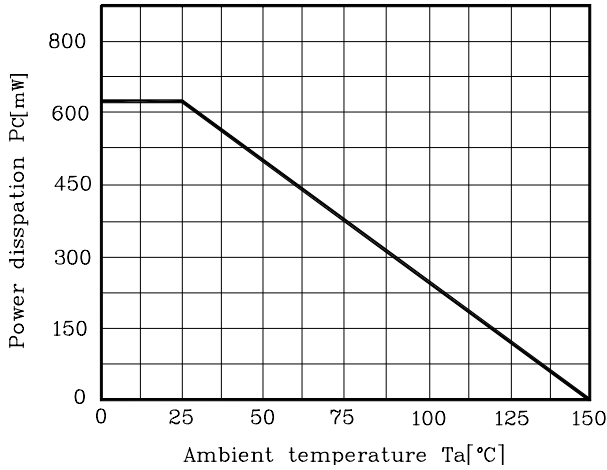

Fig. 2 $I_c - V_{BE}$

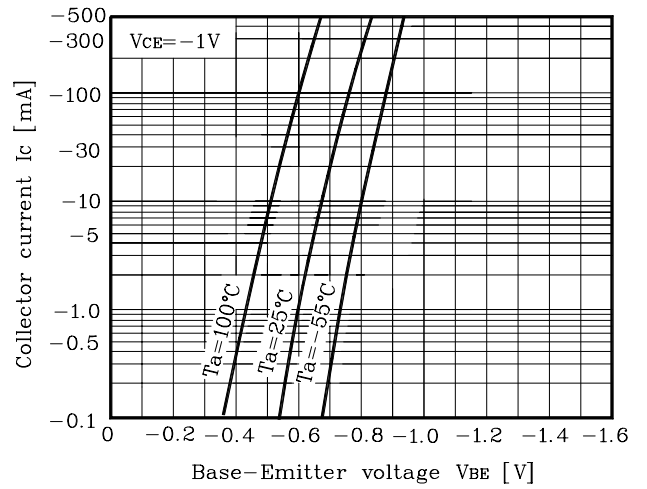

Fig. 3 $I_c - V_{CE}$

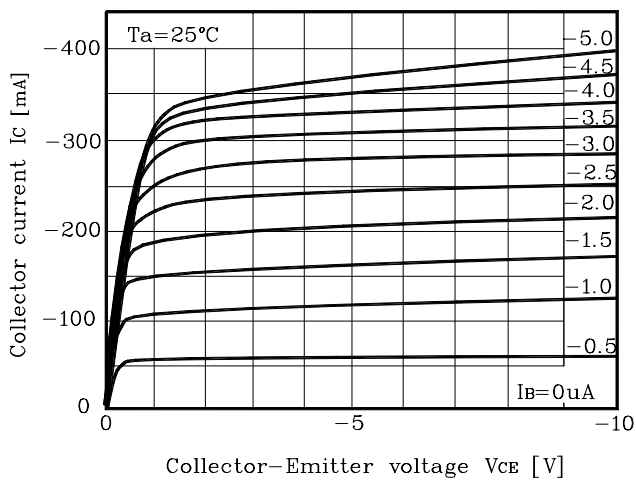

Fig. 4 $V_{CE(SAT)} - I_c$

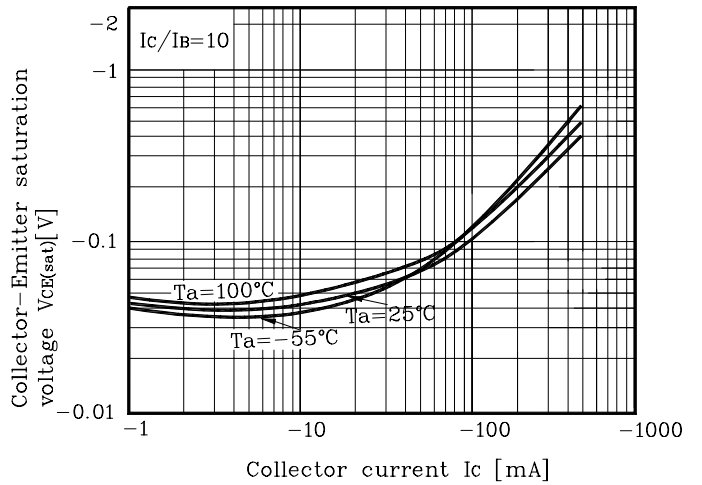

Fig. 5 $h_{FE} - I_c$

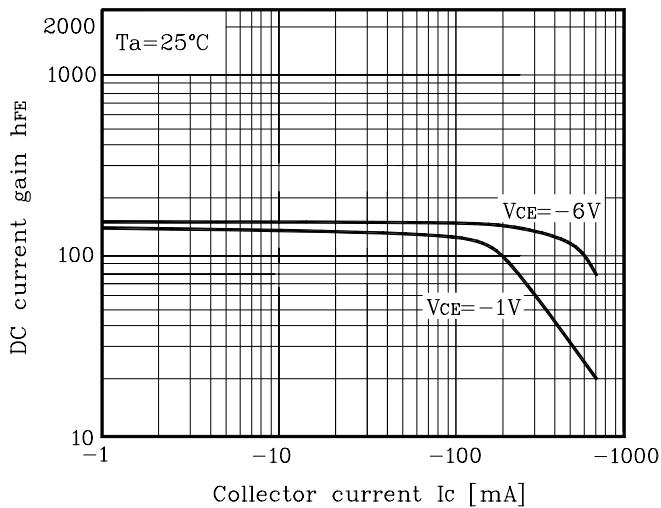
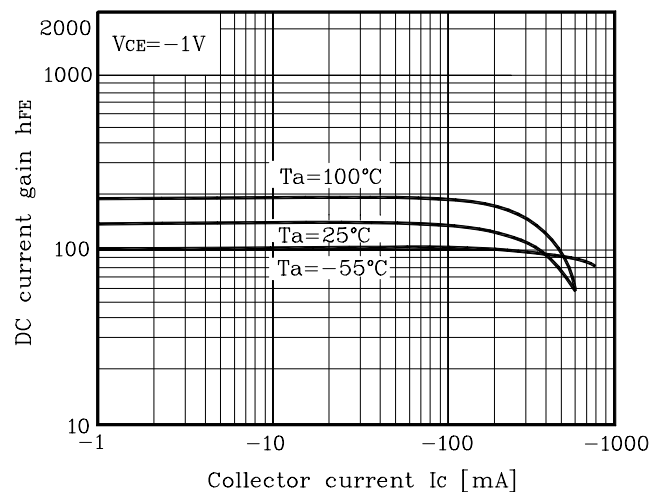

Fig. 6 $h_{FE} - I_c$



Copyright © Each Manufacturing Company.

All Datasheets cannot be modified without permission.

This datasheet has been download from :

www.AllDataSheet.com

100% Free DataSheet Search Site.

Free Download.

No Register.

Fast Search System.

www.AllDataSheet.com