

RF & MICROWAVE TRANSISTORS UHF BASE STATION APPLICATIONS

PRELIMINARY DATA

- 470 MHZ
- 24 VOLTS
- EFFICIENCY 50% MIN.
- $P_{OUT} = 15\text{ W}$ WITH 11.0 dB MIN. GAIN
- CLASS AB
- COMMON EMITTER

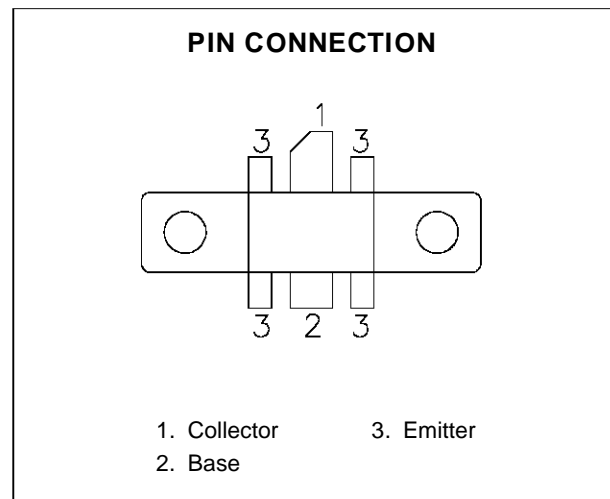
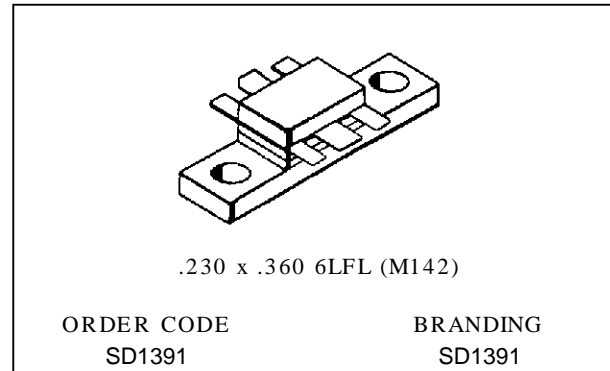

DESCRIPTION

The SD1391 is a gold metallized NPN planar transistor using diffused emitter ballast resistors for reliability and ruggedness.

The SD1391 is specifically designed as a low power, high gain driver and can be operated in Class A, B or C.

ABSOLUTE MAXIMUM RATINGS ($T_{case} = 25^{\circ}\text{C}$)

Symbol	Parameter	Value	Unit
V_{CBO}	Collector-Base Voltage	48	V
V_{CEO}	Collector-Emitter Voltage	25	V
V_{EBO}	Emitter-Base Voltage	3.5	V
I_C	Collector Current	2.5	A
P_{DISS}	Power Dissipation (+25°C)	29	W
T_J	Junction Temperature	+200	°C
T_{STG}	Storage Temperature	- 65 to +150	°C

THERMAL DATA

$R_{TH(j-c)}$	Junction-Case Thermal Resistance	6.0	°C/W
---------------	----------------------------------	-----	------

ELECTRICAL SPECIFICATIONS ($T_{\text{case}} = 25^{\circ}\text{C}$)

STATIC

Symbol	Test Conditions		Value			Unit
			Min.	Typ.	Max.	
BV_{CBO}	$I_{\text{C}} = 50 \text{ mA}$	$I_{\text{E}} = 0 \text{ mA}$	48	—	—	V
BV_{CEO}	$I_{\text{C}} = 20 \text{ mA}$	$I_{\text{B}} = 0 \text{ mA}$	25	—	—	V
BV_{EBO}	$I_{\text{E}} = 5 \text{ mA}$	$I_{\text{C}} = 0 \text{ mA}$	3.5	—	—	V
I_{CBO}	$V_{\text{CB}} = 24 \text{ V}$	$I_{\text{E}} = 0 \text{ mA}$	—	—	1.0	mA
h_{FE}	$V_{\text{CE}} = 10 \text{ V}$	$I_{\text{C}} = 0.1 \text{ A}$	10	—	100	—

DYNAMIC

Symbol	Test Conditions				Value			Unit
					Min.	Typ.	Max.	
P_{OUT}	$f = 470 \text{ MHz}$	$P_{\text{IN}} = 6.3 \text{ W}$	$V_{\text{CC}} = 24 \text{ V}$	$I_{\text{CQ}} = 50 \text{ mA}$	15	—	—	W
η_{C}	$f = 470 \text{ MHz}$	$P_{\text{IN}} = 6.3 \text{ W}$	$V_{\text{CC}} = 24 \text{ V}$	$I_{\text{CQ}} = 50 \text{ mA}$	50	60		%
R_{TL}	$f = 470 \text{ MHz}$	$P_{\text{IN}} = 6.3 \text{ W}$	$V_{\text{CC}} = 24 \text{ V}$	$I_{\text{CQ}} = 50 \text{ mA}$	10	—		dB
C_{OB}	$f = 1 \text{ MHz}$	$V_{\text{CB}} = 24 \text{ V}$			—	—	24	pF

POWER GAIN vs FREQUENCY

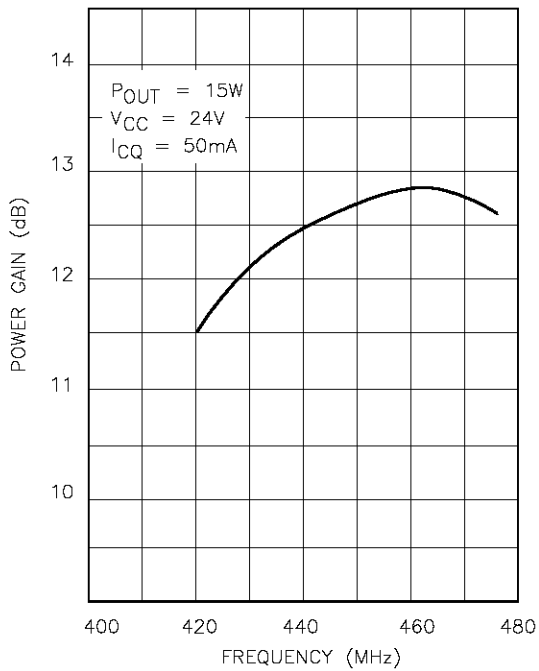

EFFICIENCY vs FREQUENCY

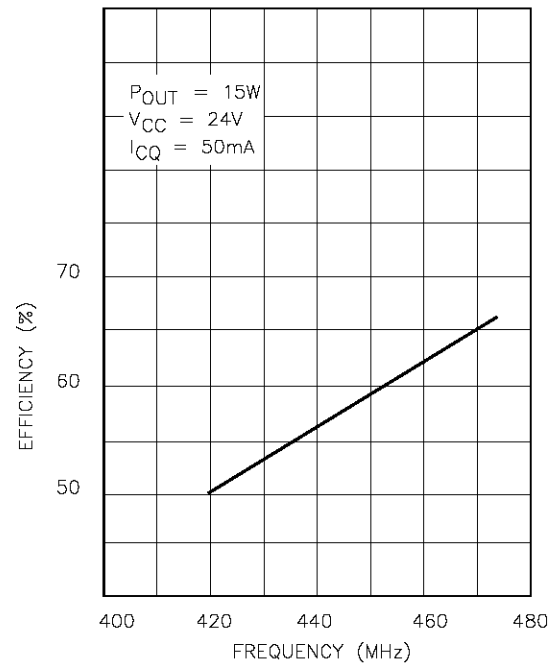

OUTPUT POWER vs INPUT POWER

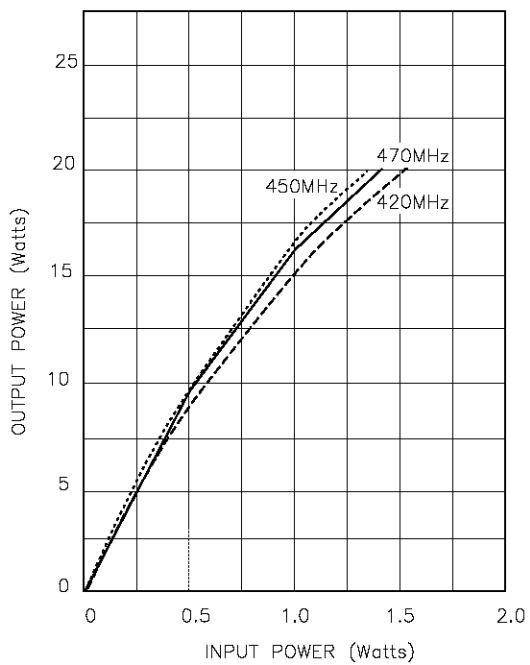

INPUT RETURN LOSS vs FREQUENCY

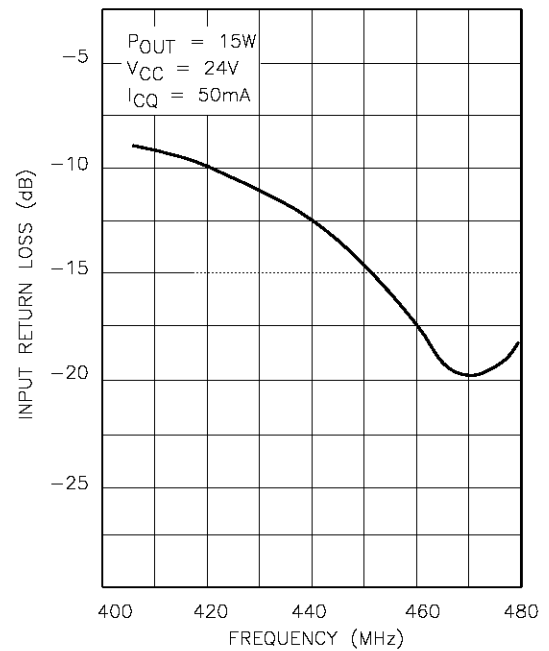

TEST CIRCUIT

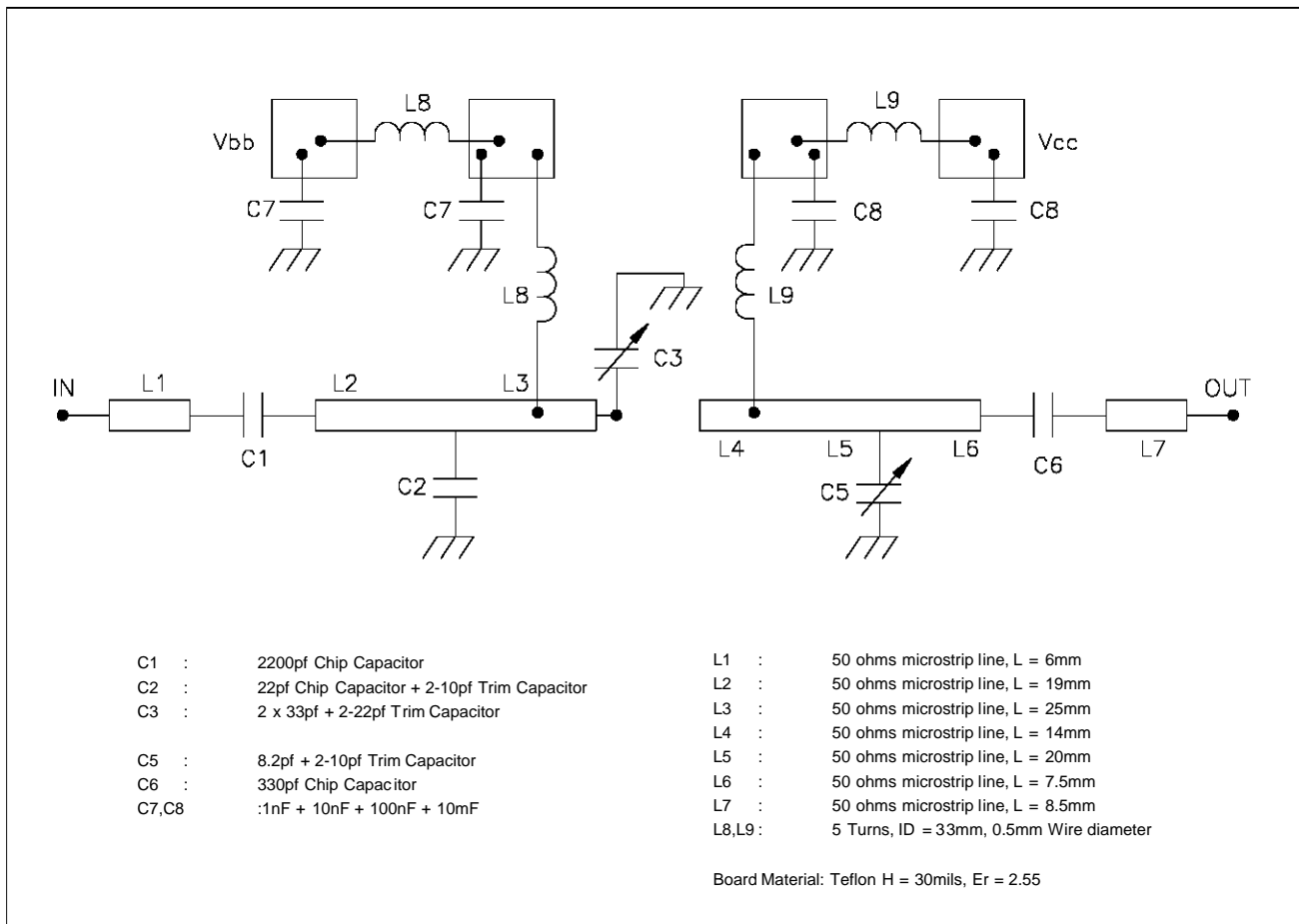

IMPEDANCE DATA

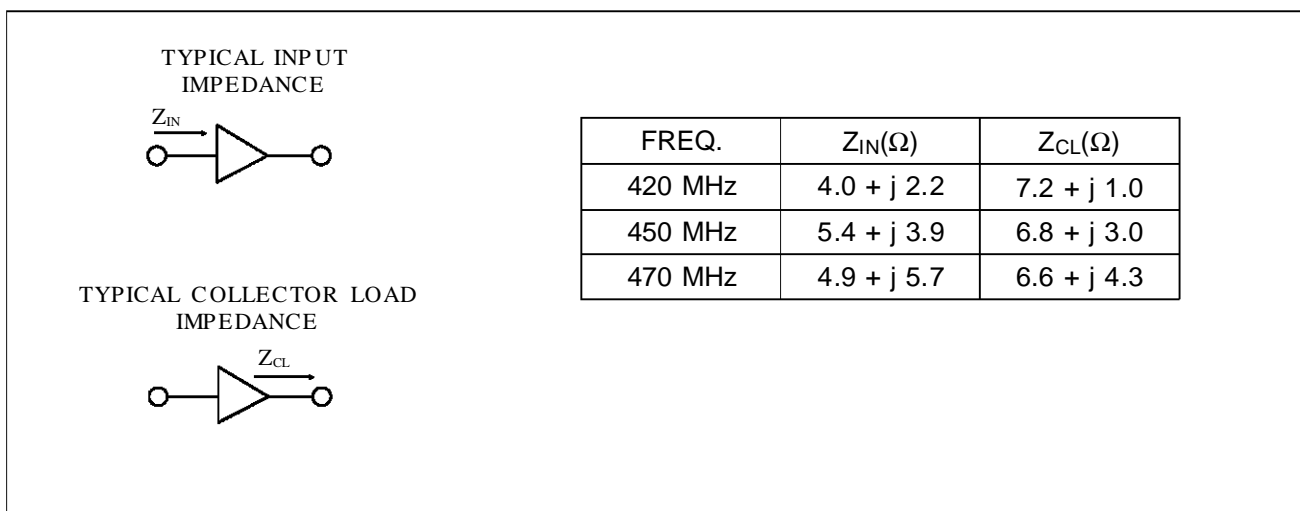

PACKAGE MECHANICAL DATA

Ref.: Dwg. No. 12-0142 rev. C
UDCS No. 1010968

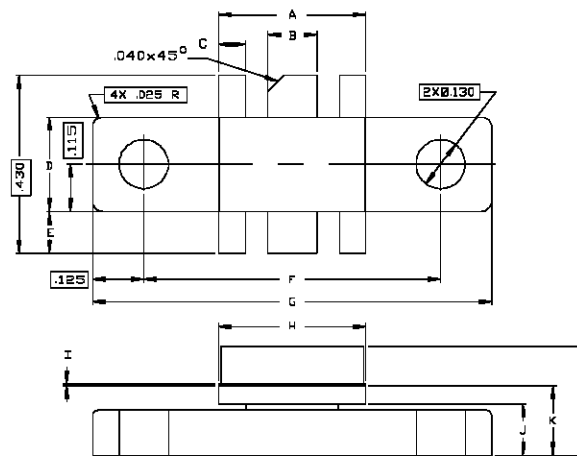

SGS-THOMSON MICROELECTRONICS			CONT'D		
	MINIMUM Inches/mm	MAXIMUM Inches/mm		MINIMUM Inches/mm	MAXIMUM Inches/mm
A	.355/9,02	.365/9,27	K	.160/4,06	.180/4,57
B	.115/2,92	.125/3,18	L	.230/5,84	.260/6,60
C	.075/1,91	.085/2,16			
D	.225/5,72	.235/5,97			
E	.090/2,29	.110/2,79			
F	.720/18,29	.730/18,54			
G	.970/24,64	.980/24,89			
H	.355/9,02	.365/9,27			
I	.004/0,10	.006/0,15			
J	.120/3,05	.130/3,30			

Information furnished is believed to be accurate and reliable. However, SGS-THOMSON Microelectronics assumes no responsibility for the consequences of use of such information nor for any infringement of patents or other rights of third parties which may result from its use. No license is granted by implication or otherwise under any patent or patent rights of SGS-THOMSON Microelectronics. Specifications mentioned in this publication are subject to change without notice. This publication supersedes and replaces all information previously supplied. SGS-THOMSON Microelectronics products are not authorized for use as critical components in life support devices or systems without express written approval of SGS-THOMSON Microelectronics.

©1996 SGS-THOMSON Microelectronics - All Rights Reserved

SGS-THOMSON Microelectronics GROUP OF COMPANIES

Australia - Brazil - France - Germany - Hong Kong - Italy - Japan - Korea - Malaysia -
Malta - Morocco - The Netherlands - Singapore - Spain - Sweden - Switzerland - Taiwan -
Thailand - United Kingdom - U.S.A.