

TOSHIBA Power Transistor Module Silicon NPN Epitaxial Type (Darlington power transistor 4 in 1)

# MP4501

High Power Switching Applications.

Hammer Drive, Pulse Motor Drive and Inductive Load Switching.

- Package with heat sink isolated to lead (SIP 12 pin)
- High collector power dissipation (4 devices operation)  
:  $P_T = 5 \text{ W}$  ( $T_a = 25^\circ\text{C}$ )
- High collector current:  $I_C \text{ (DC)} = 3 \text{ A}$  (max)
- High DC current gain:  $h_{FE} = 2000$  (min) ( $V_{CE} = 2 \text{ V}$ ,  $I_C = 1.5 \text{ A}$ )
- Diode included for absorbing fly-back voltage.

## Maximum Ratings ( $T_a = 25^\circ\text{C}$ )

Characteristics		Symbol	Rating	Unit
Collector-base voltage		$V_{CBO}$	120	V
Collector-emitter voltage		$V_{CEO}$	100	V
Emitter-base voltage		$V_{EBO}$	6	V
Collector current	DC	$I_C$	3	A
	Pulse	$I_{CP}$	6	
Continuous base current		$I_B$	0.5	A
Collector power dissipation (1 device operation)		$P_C$	3.0	W
Collector power dissipation (4 devices operation)	$T_a = 25^\circ\text{C}$	$P_T$	5.0	W
	$T_c = 25^\circ\text{C}$		25	
Isolation voltage		$V_{Isol}$	1000	V
Junction temperature		$T_j$	150	$^\circ\text{C}$
Storage temperature range		$T_{stg}$	-55 to 150	$^\circ\text{C}$

Industrial Applications

Unit: mm

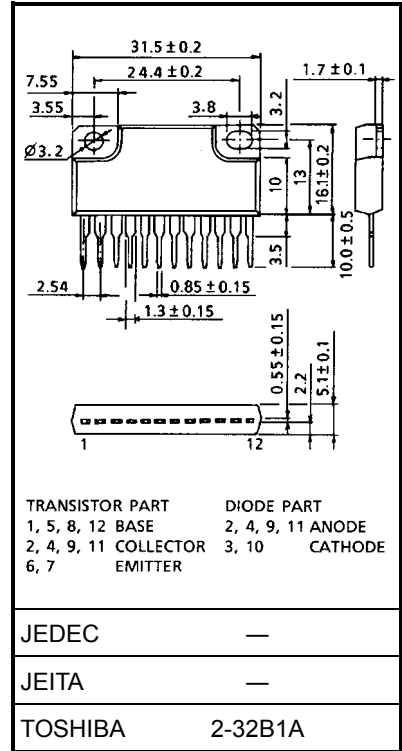

Weight: 6.0 g (typ.)

## Array Configuration

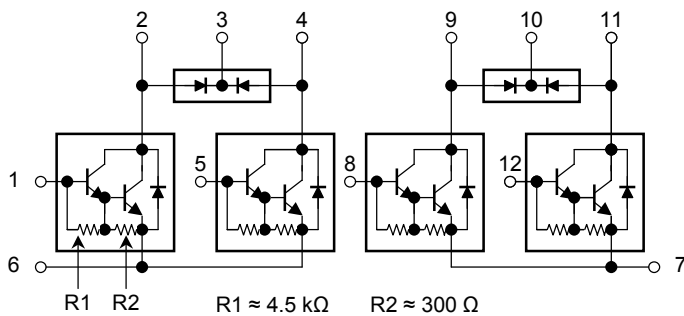

## Thermal Characteristics

Characteristics	Symbol	Max	Unit
Thermal resistance of junction to ambient (4 devices operation, $T_a = 25^\circ\text{C}$ )	$\Sigma R_{th(j-a)}$	25	$^\circ\text{C/W}$
Thermal resistance of junction to case (4 devices operation, $T_c = 25^\circ\text{C}$ )	$\Sigma R_{th(j-c)}$	5.0	$^\circ\text{C/W}$
Maximum lead temperature for soldering purposes (3.2 mm from case for 10 s)	$T_L$	260	$^\circ\text{C}$

## Electrical Characteristics ( $T_a = 25^\circ\text{C}$ )

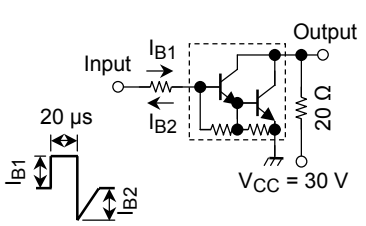
Characteristics		Symbol	Test Condition	Min	Typ.	Max	Unit
Collector cut-off current		$I_{CBO}$	$V_{CB} = 120\text{ V}, I_E = 0\text{ A}$	—	—	10	$\mu\text{A}$
Collector cut-off current		$I_{CEO}$	$V_{CE} = 100\text{ V}, I_B = 0\text{ A}$	—	—	10	$\mu\text{A}$
Emitter cut-off current		$I_{EBO}$	$V_{EB} = 6\text{ V}, I_C = 0\text{ A}$	0.5	—	2.5	mA
Collector-base breakdown voltage		$V_{(BR)CBO}$	$I_C = 1\text{ mA}, I_E = 0\text{ A}$	120	—	—	V
Collector-emitter breakdown voltage		$V_{(BR)CEO}$	$I_C = 10\text{ mA}, I_B = 0\text{ A}$	100	—	—	V
DC current gain		$h_{FE(1)}$	$V_{CE} = 2\text{ V}, I_C = 1.5\text{ A}$	2000	—	15000	—
		$h_{FE(2)}$	$V_{CE} = 2\text{ V}, I_C = 3\text{ A}$	1000	—	—	
Saturation voltage	Collector-emitter	$V_{CE(sat)}$	$I_C = 1.5\text{ A}, I_B = 3\text{ mA}$	—	—	1.5	V
	Base-emitter	$V_{BE(sat)}$	$I_C = 1.5\text{ A}, I_B = 3\text{ mA}$	—	—	2.0	
Transition frequency		$f_T$	$V_{CE} = 2\text{ V}, I_C = 0.5\text{ A}$	—	60	—	MHz
Collector output capacitance		$C_{ob}$	$V_{CB} = 10\text{ V}, I_E = 0\text{ A}, f = 1\text{ MHz}$	—	30	—	pF
Switching time	Turn-on time	$t_{on}$	 <p><math>I_{B1} = -I_{B2} = 3\text{ mA}, \text{duty cycle} \leq 1\%</math></p>	—	0.3	—	$\mu\text{s}$
	Storage time	$t_{stg}$		—	2.0	—	
	Fall time	$t_f$		—	0.4	—	

## Emitter-Collector Diode Ratings and Characteristics ( $T_a = 25^\circ\text{C}$ )

Characteristics	Symbol	Test Condition	Min	Typ.	Max	Unit
Maximum forward current	$I_{FM}$	—	—	—	3	A
Surge current	$I_{FSM}$	$t = 1\text{ s}, 1\text{ shot}$	—	—	6	A
Forward voltage	$V_F$	$I_F = 1\text{ A}, I_B = 0\text{ A}$	—	1.2	1.8	V
Reverse recovery time	$t_{rr}$	$I_F = 3\text{ A}, V_{BE} = -3\text{ V}, dI_F/dt = -50\text{ A}/\mu\text{s}$	—	1.0	—	$\mu\text{s}$
Reverse recovery charge	$Q_{rr}$		—	5	—	$\mu\text{C}$

**Flyback-Diode Rating and Characteristics (Ta = 25°C)**

Characteristics	Symbol	Test Condition	Min	Typ.	Max	Unit
Maximum forward current	$I_{FM}$	—	—	—	3	A
Reverse current	$I_R$	$V_R = 120\text{ V}$	—	—	0.4	$\mu\text{A}$
Reverse voltage	$V_R$	$I_R = 100\ \mu\text{A}$	120	—	—	V
Forward voltage	$V_F$	$I_F = 0.5\text{ A}$	—	—	1.8	V

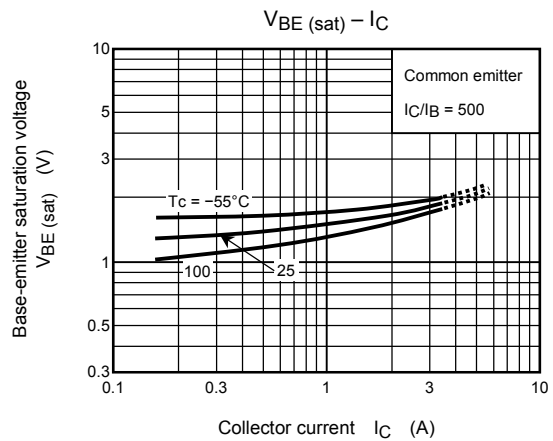
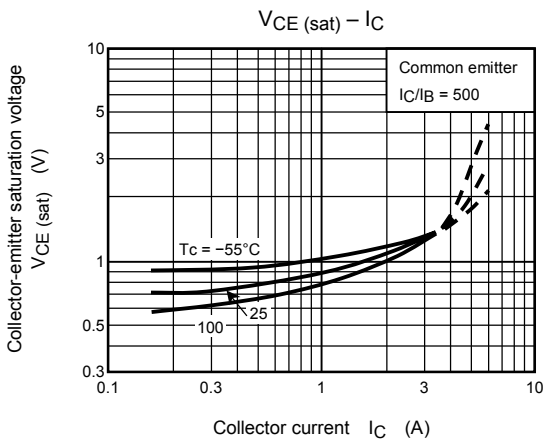
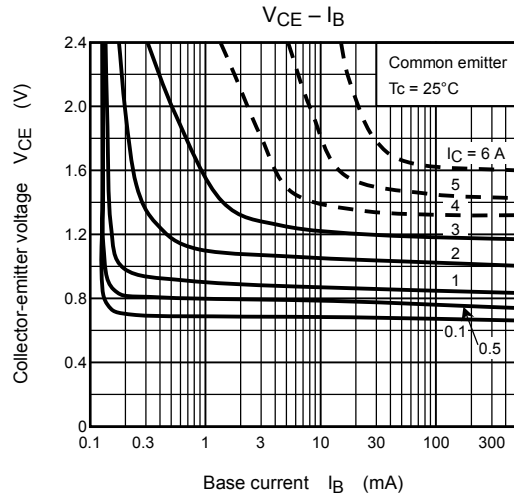
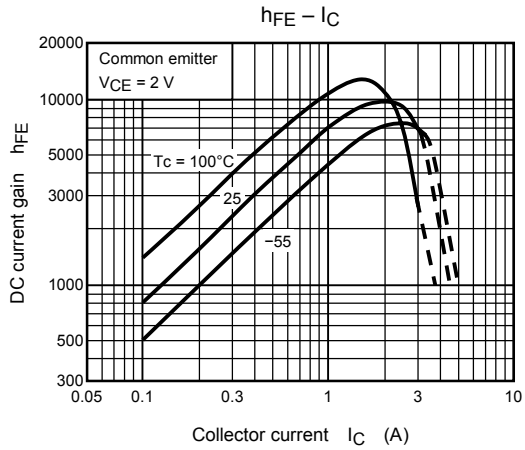
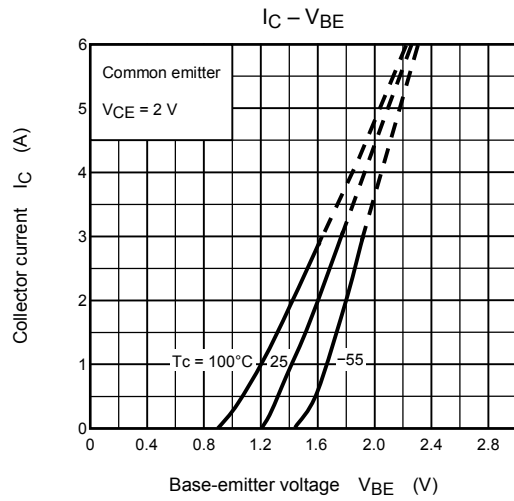
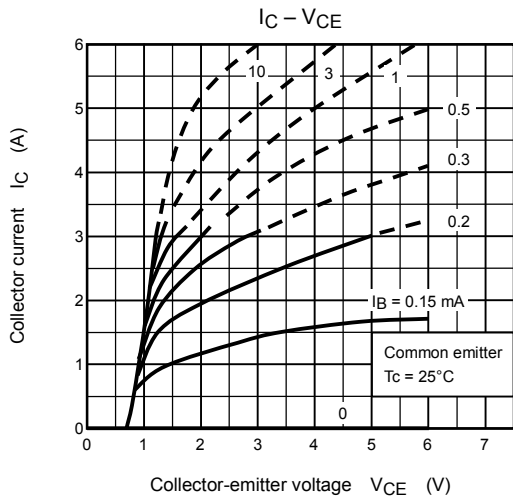

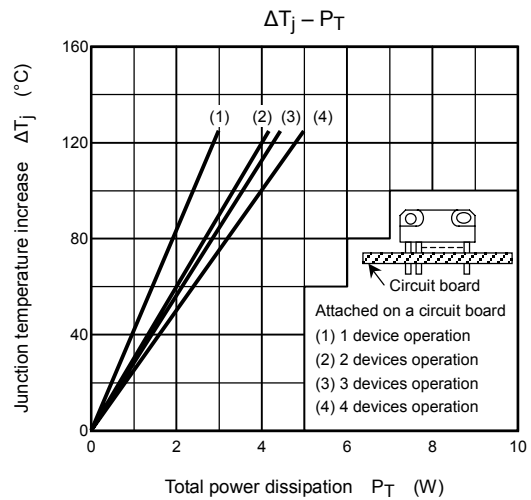
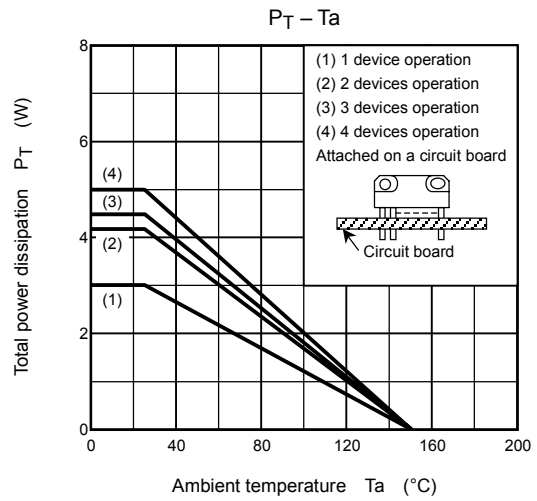
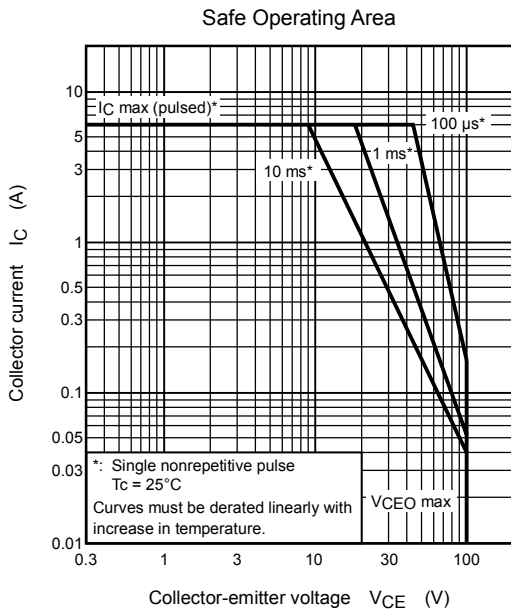
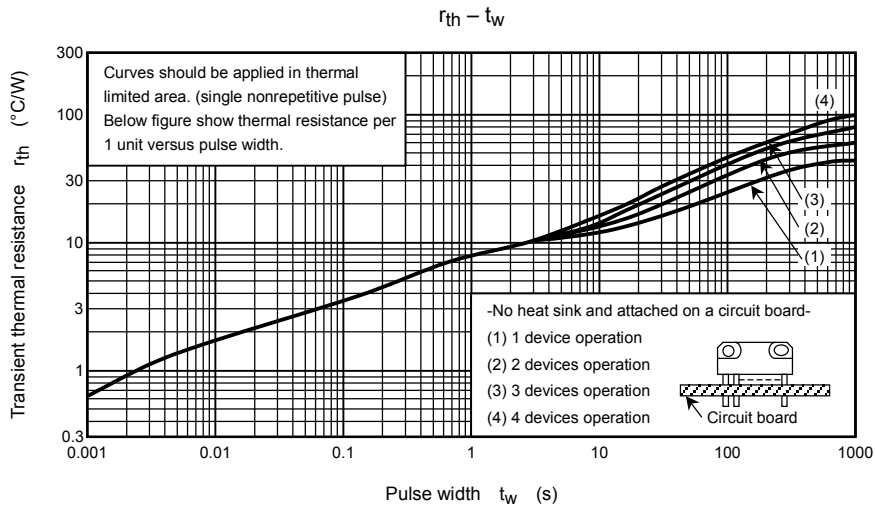

**RESTRICTIONS ON PRODUCT USE**

000707EAA

- TOSHIBA is continually working to improve the quality and reliability of its products. Nevertheless, semiconductor devices in general can malfunction or fail due to their inherent electrical sensitivity and vulnerability to physical stress. It is the responsibility of the buyer, when utilizing TOSHIBA products, to comply with the standards of safety in making a safe design for the entire system, and to avoid situations in which a malfunction or failure of such TOSHIBA products could cause loss of human life, bodily injury or damage to property.  
In developing your designs, please ensure that TOSHIBA products are used within specified operating ranges as set forth in the most recent TOSHIBA products specifications. Also, please keep in mind the precautions and conditions set forth in the "Handling Guide for Semiconductor Devices," or "TOSHIBA Semiconductor Reliability Handbook" etc..
- The TOSHIBA products listed in this document are intended for usage in general electronics applications (computer, personal equipment, office equipment, measuring equipment, industrial robotics, domestic appliances, etc.). These TOSHIBA products are neither intended nor warranted for usage in equipment that requires extraordinarily high quality and/or reliability or a malfunction or failure of which may cause loss of human life or bodily injury ("Unintended Usage"). Unintended Usage include atomic energy control instruments, airplane or spaceship instruments, transportation instruments, traffic signal instruments, combustion control instruments, medical instruments, all types of safety devices, etc.. Unintended Usage of TOSHIBA products listed in this document shall be made at the customer's own risk.
- The information contained herein is presented only as a guide for the applications of our products. No responsibility is assumed by TOSHIBA CORPORATION for any infringements of intellectual property or other rights of the third parties which may result from its use. No license is granted by implication or otherwise under any intellectual property or other rights of TOSHIBA CORPORATION or others.
- The information contained herein is subject to change without notice.