

PN100/PN100A/MMBT100/MMBT100A

NPN General Purpose Amplifier

- This device is designed for general purpose amplifier applications at collector currents to 300mA.
- Sourced from process 10.

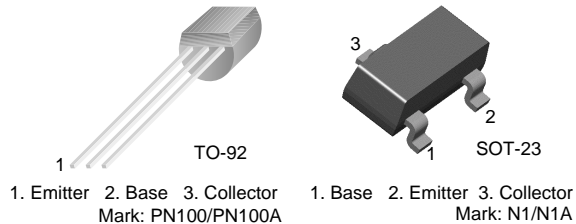

Absolute Maximum Ratings* $T_C=25^\circ\text{C}$ unless otherwise noted

Symbol	Parameter	Value	Units
V_{CEO}	Collector-Emitter Voltage	45	V
V_{CBO}	Collector-Base Voltage	75	V
V_{EBO}	Emitter-Base Voltage	6.0	V
I_C	Collector current - Continuous	500	mA
T_J, T_{stg}	Junction and Storage Temperature	-55 ~ +150	$^\circ\text{C}$

* These ratings are limiting values above which the serviceability of any semiconductor device may be impaired.

NOTES:

- These ratings are based on a maximum junction temperature of 150 degrees C.
- These are steady state limits. The factory should be consulted on applications involving pulsed or low duty cycle operations.

Electrical Characteristics $T_C=25^\circ\text{C}$ unless otherwise noted

Symbol	Parameter	Test Condition	Min.	Max.	Units
Off Characteristics					
BV_{CBO}	Collector-Base Breakdown Voltage	$I_C = 10\mu\text{A}, I_E = 0$	75		V
BV_{CEO}	Collector-Emitter Breakdown Voltage *	$I_C = 1\text{mA}, I_B = 0$	45		V
BV_{EBO}	Emitter-Base Breakdown Voltage	$I_E = 10\mu\text{A}, I_C = 0$	6.0		V
I_{CBO}	Collector-Base Cutoff Current	$V_{CB} = 60\text{V}$		50	nA
I_{CES}	Collector-Emitter Cutoff Current	$V_{CE} = 40\text{V}$		50	nA
I_{EBO}	Emitter Cutoff Current	$V_{EB} = 4\text{V}$		50	nA
On Characteristics					
h_{FE}	DC Current Gain	$I_C = 100\mu\text{A}, V_{CE} = 1.0\text{V}$ $I_C = 10\text{mA}, V_{CE} = 1.0\text{V}$ $I_C = 100\text{mA}, V_{CE} = 1.0\text{V}^*$ $I_C = 150\text{mA}, V_{CE} = 5.0\text{V}^*$	100 100A 100 100A	80 240 100 300 100 100 350 100	
$V_{CE(sat)}$	Collector-Emitter Saturation Voltage	$I_C = 10\text{mA}, I_B = 1.0\text{mA}$ $I_C = 200\text{mA}, I_B = 20\text{mA}$		0.2 0.4	V V
$V_{BE(sat)}$	Base-Emitter Saturation Voltage	$I_C = 10\text{mA}, I_B = 1.0\text{mA}$ $I_C = 200\text{mA}, I_B = 20\text{mA}$		0.85 1.0	V V
Small Signal Characteristics					
f_T	Current Gain Bandwidth Product	$V_{CE} = 20\text{V}, I_C = 20\text{mA}$	250		MHz
C_{obo}	Output Capacitance	$V_{CB} = 5.0\text{V}, f = 1.0\text{MHz}$		4.5	pF
NF	Noise Figure	$I_C = 100\mu\text{A}, V_{CE} = 5.0\text{V}$ $R_G = 2.0\text{k}\Omega, f = 1.0\text{KHz}$	100 100A	5.0 4.0	dB dB

* Pulse Test: Pulse Width $\leq 300\mu\text{s}$, Duty Cycle $\leq 2.0\%$

Thermal Characteristics $T_A=25^{\circ}\text{C}$ unless otherwise noted

Symbol	Parameter	Max.		Units
		PN100 PN100A	*MMBT100 *MMBT100A	
P_D	Total Device Dissipation	625	350	mW
	Derate above 25°C	5.0	2.8	mW/°C
$R_{\theta JC}$	Thermal Resistance, Junction to Case	83.3		°C/W
$R_{\theta JA}$	Thermal Resistance, Junction to Ambient	200	357	°C/W

* Device mounted on FR-4 PCB 1.6" x 1.6" x 0.06."

Typical Characteristics

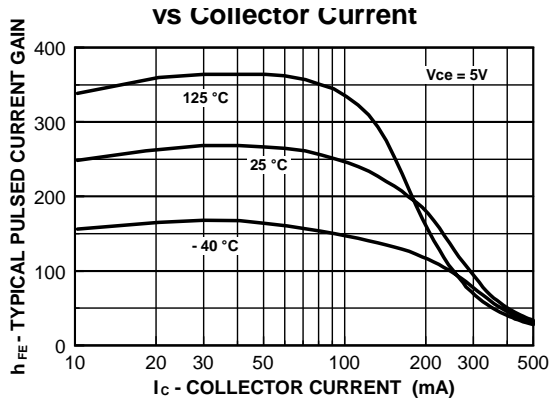

Figure 1. Typical Pulsed Current Gain vs Collector Current

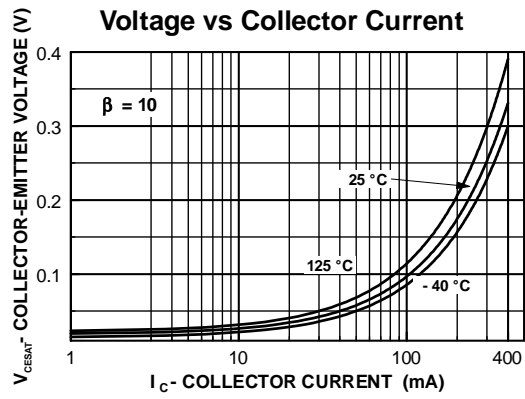

Figure 2. Collector-Emitter Saturation Voltage vs Collector Current

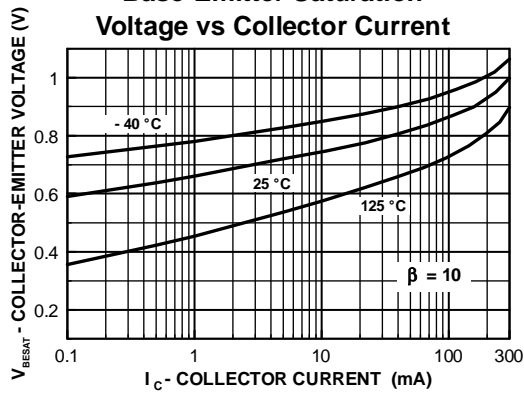

Figure 3. Base-Emitter Saturation Voltage vs Collector Current

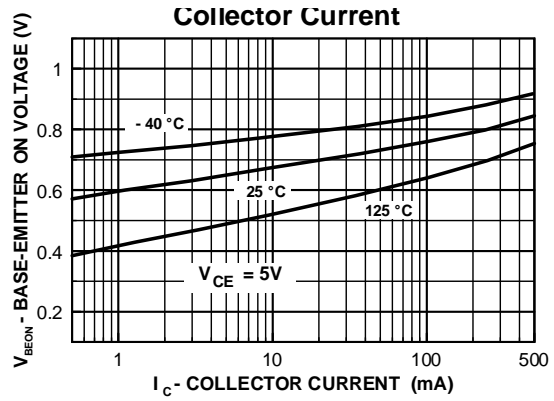

Figure 4. Base-Emitter On Voltage vs Collector Current

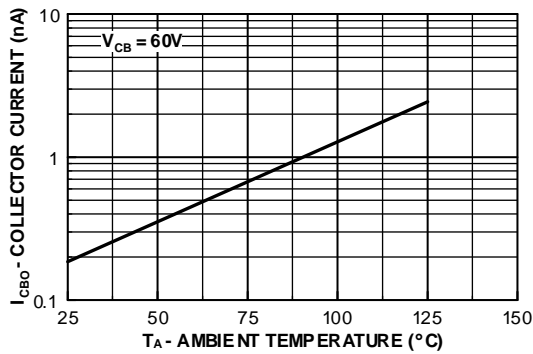

Figure 5. Collector Cutoff Current vs Ambient Temperature

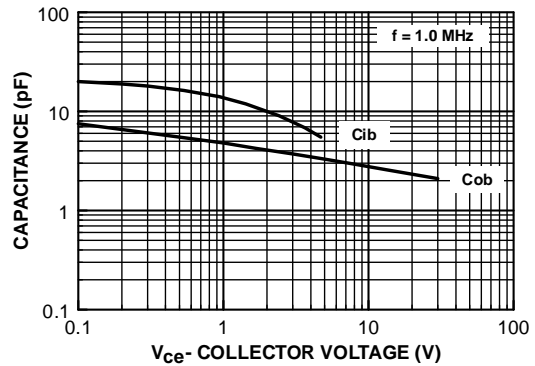

Figure 6. Input and Output Capacitance vs Reverse Voltag

Typical Characteristics (Continued)

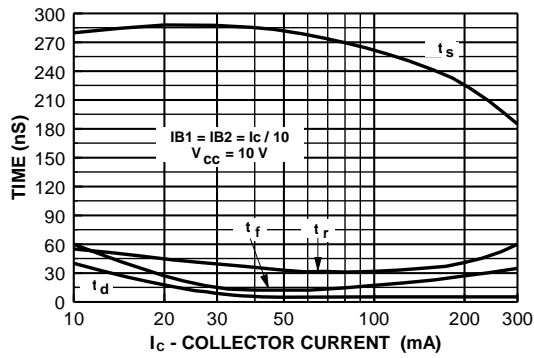

Figure 7. Switching Times vs Collector Current

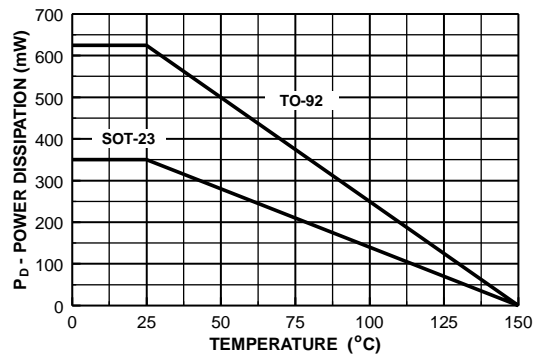
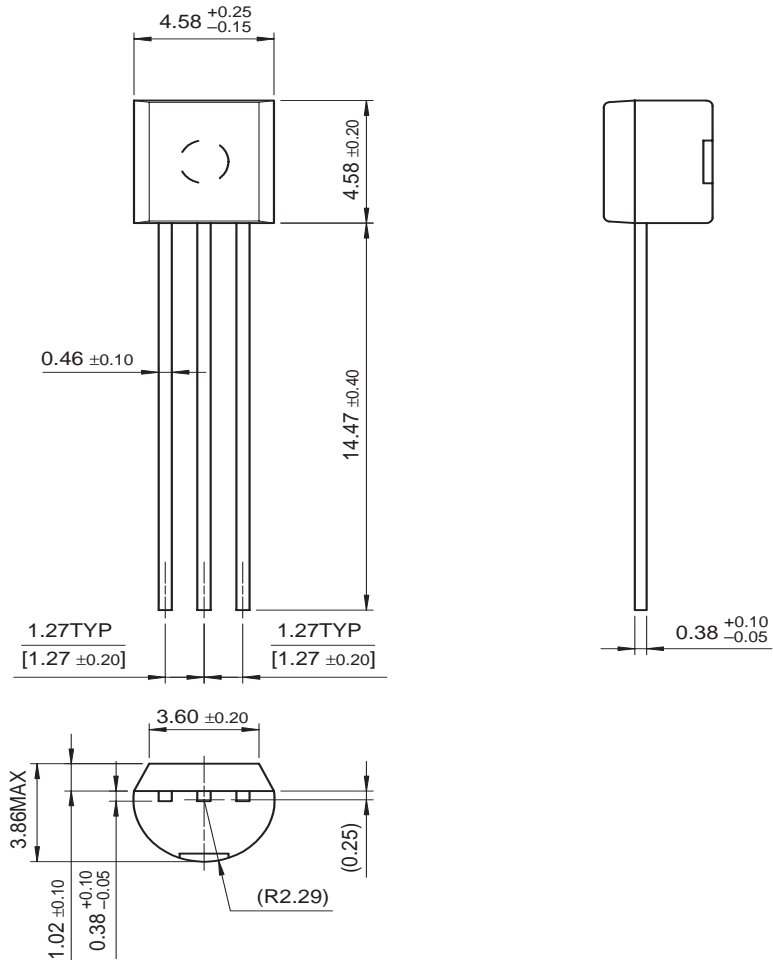

Figure 8. Power Dissipation vs Ambient Temperature

Package Dimensions

TO-92



PN100/PN100A/MMBT100/MMBT100A

Dimensions in Millimeters

Package Dimensions (Continued)

SOT-23

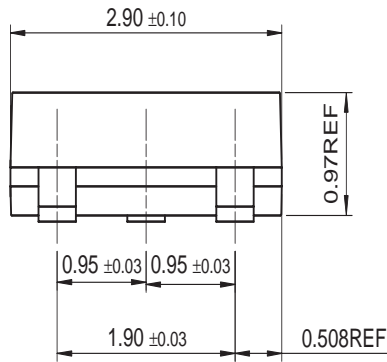
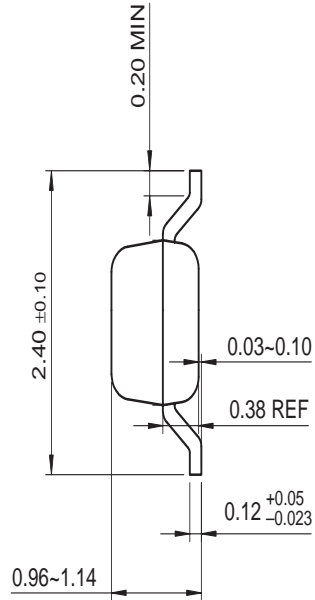
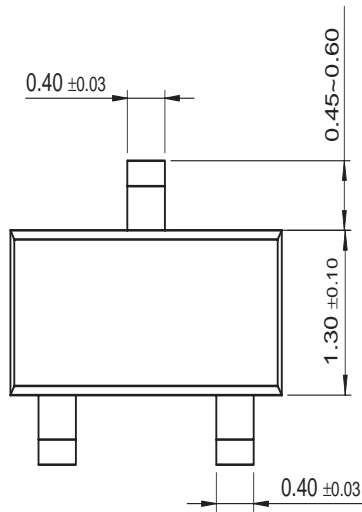

Dimensions in Millimeters

PN100/PN100A/MMBT100/MMBT100A

TRADEMARKS

The following are registered and unregistered trademarks Fairchild Semiconductor owns or is authorized to use and is not intended to be an exhaustive list of all such trademarks.

ACE ^x TM	FACT Quiet Series TM	OCX TM	SILENT SWITCHER [®]	UniFET TM
ActiveArray TM	GlobalOptoisolator TM	OCXPro TM	SMART START TM	UltraFET [®]
Bottomless TM	GTO TM	OPTOLOGIC [®]	SPM TM	VCX TM
Build it Now TM	HiSeC TM	OPTOPLANAR TM	Stealth TM	Wire TM
CoolFET TM	I ² C TM	PACMAN TM	SuperFET TM	
CROSSVOLT TM	<i>i-Lo</i> TM	POP TM	SuperSOT TM -3	
DOMET TM	ImpliedDisconnect TM	Power247 TM	SuperSOT TM -6	
EcoSPARK TM	IntelliMAX TM	PowerEdge TM	SuperSOT TM -8	
E ² CMOS TM	ISOPLANAR TM	PowerSaver TM	SyncFET TM	
EnSigna TM	LittleFET TM	PowerTrench [®]	TCM TM	
FACT TM	MICROCOUPLER TM	QFET [®]	TinyBoost TM	
FAST [®]	MicroFET TM	QS TM	TinyBuck TM	
FAST _r TM	MicroPak TM	QT Optoelectronics TM	TinyPWM TM	
FPS TM	MICROWIRE TM	Quiet Series TM	TinyPower TM	
FRFET TM	MSX TM	RapidConfigure TM	TinyLogic [®]	
	MSXPro TM	RapidConnect TM	TINYOPTO TM	
Across the board. Around the world. TM		μSerDes TM	TruTranslation TM	
The Power Franchise [®]		ScalarPump TM	UHC TM	
Programmable Active Droop TM				

DISCLAIMER

FAIRCHILD SEMICONDUCTOR RESERVES THE RIGHT TO MAKE CHANGES WITHOUT FURTHER NOTICE TO ANY PRODUCTS HEREIN TO IMPROVE RELIABILITY, FUNCTION, OR DESIGN. FAIRCHILD DOES NOT ASSUME ANY LIABILITY ARISING OUT OF THE APPLICATION OR USE OF ANY PRODUCT OR CIRCUIT DESCRIBED HEREIN; NEITHER DOES IT CONVEY ANY LICENSE UNDER ITS PATENT RIGHTS, NOR THE RIGHTS OF OTHERS. THESE SPECIFICATIONS DO NOT EXPAND THE TERMS OF FAIRCHILD'S WORLDWIDE TERMS AND CONDITIONS, SPECIFICALLY THE WARRANTY THEREIN, WHICH COVERS THESE PRODUCTS.

LIFE SUPPORT POLICY

FAIRCHILD'S PRODUCTS ARE NOT AUTHORIZED FOR USE AS CRITICAL COMPONENTS IN LIFE SUPPORT DEVICES OR SYSTEMS WITHOUT THE EXPRESS WRITTEN APPROVAL OF FAIRCHILD SEMICONDUCTOR CORPORATION.

As used herein:

- Life support devices or systems are devices or systems which, (a) are intended for surgical implant into the body, or (b) support or sustain life, or (c) whose failure to perform when properly used in accordance with instructions for use provided in the labeling, can be reasonably expected to result in significant injury to the user.
- A critical component is any component of a life support device or system whose failure to perform can be reasonably expected to cause the failure of the life support device or system, or to affect its safety or effectiveness.

PRODUCT STATUS DEFINITIONS

Definition of Terms

Datasheet Identification	Product Status	Definition
Advance Information	Formative or In Design	This datasheet contains the design specifications for product development. Specifications may change in any manner without notice.
Preliminary	First Production	This datasheet contains preliminary data, and supplementary data will be published at a later date. Fairchild Semiconductor reserves the right to make changes at any time without notice to improve design.
No Identification Needed	Full Production	This datasheet contains final specifications. Fairchild Semiconductor reserves the right to make changes at any time without notice to improve design.
Obsolete	Not In Production	This datasheet contains specifications on a product that has been discontinued by Fairchild semiconductor. The datasheet is printed for reference information only.