

KSC5402D/KSC5402DT

High Voltage High Speed Power Switch Application

- Wide Safe Operating Area
- Built-in Free Wheeling Diode
- Suitable for Electronic Ballast Application
- Small Variance in Storage Time
- Two Package Choices; D-PAK or TO-220

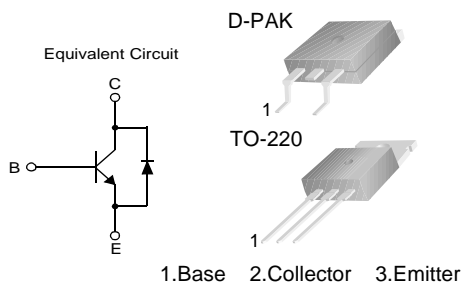

NPN Silicon Transistor Planar Silicon Transistor

Absolute Maximum Ratings $T_C=25^\circ\text{C}$ unless otherwise noted

Symbol	Parameter	Value	Units
V_{CBO}	Collector-Base Voltage	1000	V
V_{CEO}	Collector-Emitter Voltage	450	V
V_{EBO}	Emitter-Base Voltage	12	V
I_C	Collector Current (DC)	2	A
I_{CP}	*Collector Current (Pulse)	5	A
I_B	Base Current (DC)	1	A
I_{BP}	*Base Current (Pulse)	2	A
P_C	Power Dissipation($T_C=25^\circ\text{C}$) : D-PAK * : TO-220	30 50	W
T_J	Junction Temperature	150	$^\circ\text{C}$
T_{STG}	Storage Temperature	- 65 ~ 150	$^\circ\text{C}$

* Pulse Test: Pulse Width=5ms, Duty Cycle \leq 10%

Thermal Characteristics $T_C=25^\circ\text{C}$ unless otherwise noted

Symbol	Characteristics	Rating		Unit	
		TO-220	D-PAK		
$R_{\theta jc}$	Thermal Resistance	Junction to Case	2.5	4.17 *	$^\circ\text{C}/\text{W}$
$R_{\theta ja}$		Junction to Ambient	62.5	50	
T_L	Maximum Lead Temperature for Soldering Purpose ; 1/8" from Case for 5 Seconds		270	270	$^\circ\text{C}$

* Mounted on 1" square PCB (FR4 ro G-10 Material)

Electrical Characteristics $T_C=25^\circ\text{C}$ unless otherwise noted

Symbol	Parameter	Test Condition	Min.	Typ.	Max.	Units
BV_{CBO}	Collector-Base Breakdown Voltage	$I_C=1\text{mA}, I_E=0$	1000	1090		V
BV_{CEO}	Collector-Emitter Breakdown Voltage	$I_C=5\text{mA}, I_B=0$	450	525		V
BV_{EBO}	Emitter-Base Breakdown Voltage	$I_E=1\text{mA}, I_C=0$	12	14		V
I_{CES}	Collector Cut-off Current	$V_{CES}=1000\text{V}, I_{EB}=0$	$T_C=25^\circ\text{C}$	0.03	100	μA
			$T_C=125^\circ\text{C}$	1.2	500	
I_{CEO}	Collector Cut-off Current	$V_{CE}=450\text{V}, V_B=0$	$T_C=25^\circ\text{C}$	0.3	100	μA
			$T_C=125^\circ\text{C}$	15	500	
I_{EBO}	Emitter Cut-off Current	$V_{EB}=10\text{V}, I_C=0$		0.01	100	μA
h_{FE}	DC Current Gain	$V_{CE}=1\text{V}, I_C=0.4\text{A}$	$T_C=25^\circ\text{C}$	14	29	
			$T_C=125^\circ\text{C}$	8	17	
		$V_{CE}=1\text{V}, I_C=1\text{A}$	$T_C=25^\circ\text{C}$	6	9	
			$T_C=125^\circ\text{C}$	4	6	
$V_{CE(sat)}$	Collector-Emitter Saturation Voltage	$I_C=0.4, I_B=0.04\text{A}$	$T_C=25^\circ\text{C}$	0.25	0.6	
			$T_C=125^\circ\text{C}$	0.4	1.0	
		$I_C=1\text{A}, I_B=0.2\text{A}$	$T_C=25^\circ\text{C}$	0.3	0.75	V
			$T_C=125^\circ\text{C}$	0.65	1.2	V
$V_{BE(sat)}$	Base-Emitter Saturation Voltage	$I_C=0.4\text{A}, I_B=0.04\text{A}$	$T_C=25^\circ\text{C}$	0.78	1.0	V
			$T_C=125^\circ\text{C}$	0.65	0.9	V
		$I_C=1\text{A}, I_B=0.2\text{A}$	$T_C=25^\circ\text{C}$	0.85	1.1	V
			$T_C=125^\circ\text{C}$	0.75	1.0	V
C_{ib}	Input Capacitance	$V_{EB}=8\text{V}, I_C=0, f=1\text{MHz}$		330	500	pF
C_{ob}	Output Capacitance	$V_{CB}=10\text{V}, I_E=0, f=1\text{MHz}$		35	100	pF
f_T	Current Gain Bandwidth Product	$I_C=0.5\text{A}, V_{CE}=10\text{V}$		11		MHz
V_F	Diode Forward Voltage	$I_F=1\text{A}$	$T_C=25^\circ\text{C}$	0.86	1.5	V
			$T_C=125^\circ\text{C}$	0.75	1.2	V
		$I_F=0.2\text{A}$	$T_C=25^\circ\text{C}$	0.6		V
			$T_C=125^\circ\text{C}$	0.8	1.3	V
			$T_C=125^\circ\text{C}$	0.65		V

Electrical Characteristics $T_C=25^\circ\text{C}$ unless otherwise noted

Symbol	Parameter	Test Condition	Min	Typ.	Max.	Units	
t_{fr}	Diode Forward Recovery Time ($di/dt=10\text{A}/\mu\text{s}$)	$I_F=0.2\text{A}$		540		ns	
		$I_F=0.4\text{A}$		520		ns	
		$I_F=1\text{A}$		480		ns	
$V_{CE(DSAT)}$	Dynamic Saturation Voltage	$I_C=0.4\text{A}$, $I_{B1}=40\text{mA}$ $V_{CC}=300\text{V}$	@ $1\mu\text{s}$		7.5		V
			@ $3\mu\text{s}$		2.5		V
		$I_C=1\text{A}$, $I_{B1}=200\text{mA}$ $V_{CC}=300$	@ $1\mu\text{s}$		11.5		V
			@ $3\mu\text{s}$		1.5		V
RESISTIVE LOAD SWITCHING (D.C. $\leq 10\%$, Pulse Width= $20\mu\text{s}$)							
t_{ON}	Turn On Time	$I_C=1\text{A}$, $I_{B1}=200\text{mA}$	$T_C=25^\circ\text{C}$		110	150	ns
			$T_C=125^\circ\text{C}$		135		ns
t_{OFF}	Turn Off Time	$I_{B2}=150\text{mA}$ $V_{CC}=300\text{V}$ $R_L = 300\Omega$	$T_C=25^\circ\text{C}$	0.95		1.25	μs
			$T_C=125^\circ\text{C}$		1.4		μs
INDUCTIVE LOAD SWITCHING ($V_{CC}=15\text{V}$)							
t_{STG}	Storage Time	$I_C=0.4\text{A}$, $I_{B1}=40\text{mA}$	$T_C=25^\circ\text{C}$		0.56	0.65	μs
			$T_C=125^\circ\text{C}$		0.7		μs
t_F	Fall Time	$I_{B2}=200\text{mA}$, $V_Z=300\text{V}$ $L_C=200\text{H}$	$T_C=25^\circ\text{C}$		60	175	ns
			$T_C=125^\circ\text{C}$		75		ns
t_C	Cross-over Time		$T_C=25^\circ\text{C}$		90	175	ns
			$T_C=125^\circ\text{C}$		90		ns
t_{STG}	Storage Time	$I_C=0.8\text{A}$, $I_{B1}=160\text{mA}$	$T_C=25^\circ\text{C}$		2.75		μs
			$T_C=125^\circ\text{C}$		3		μs
t_F	Fall Time	$I_{B2}=160\text{mA}$, $V_Z=300\text{V}$ $L_C=200\text{H}$	$T_C=25^\circ\text{C}$		110	175	ns
			$T_C=125^\circ\text{C}$		180		ns
t_C	Cross-over Time		$T_C=25^\circ\text{C}$		125	350	ns
			$T_C=125^\circ\text{C}$		185		ns
t_{STG}	Storage Time	$I_C=1\text{A}$, $I_{B1}=200\text{mA}$	$T_C=25^\circ\text{C}$		1.1	1.2	μs
			$T_C=125^\circ\text{C}$		1.35		μs
t_F	Fall Time	$I_{B2}=500\text{mA}$, $V_Z=300\text{V}$ $L_C=200\mu\text{H}$	$T_C=25^\circ\text{C}$		105	150	ns
			$T_C=125^\circ\text{C}$		75		ns
t_C	Cross-over Time		$T_C=25^\circ\text{C}$		125	150	ns
			$T_C=125^\circ\text{C}$		100		ns

Typical Characteristics

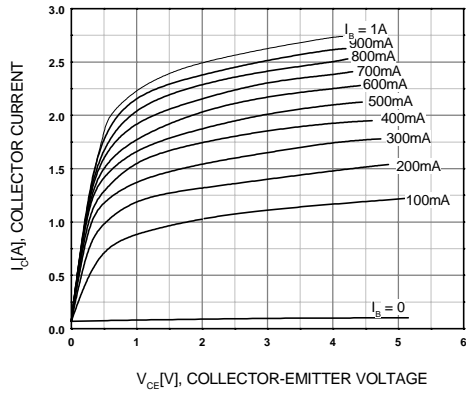

Figure 1. Static Characteristic

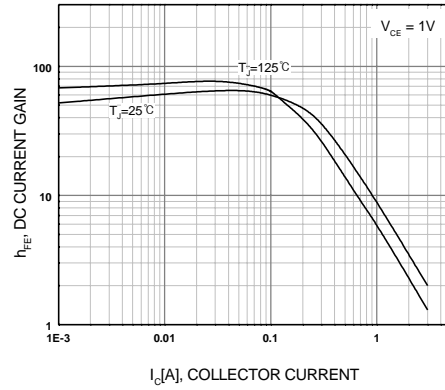

Figure 2. DC current Gain

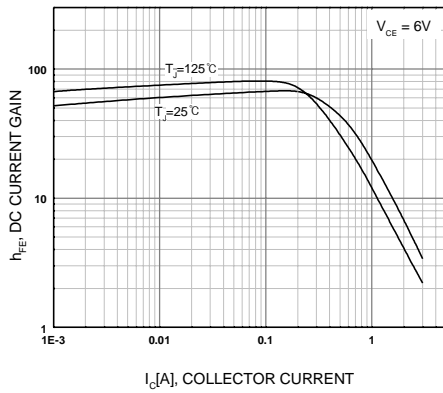

Figure 3. DC current Gain

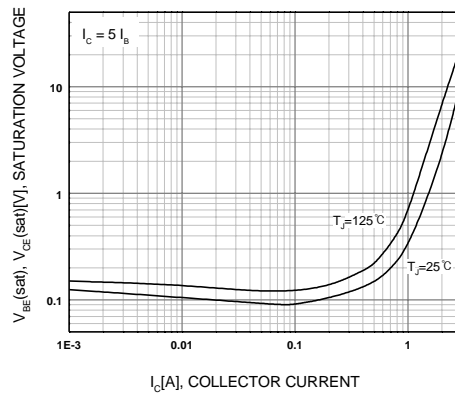

Figure 4. Collector-Emitter Saturation Voltage

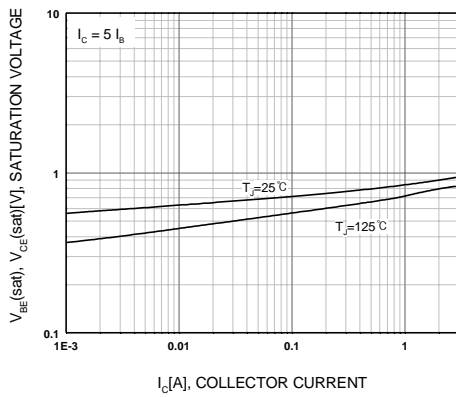

Figure 5. Base-Emitter Saturation Voltage

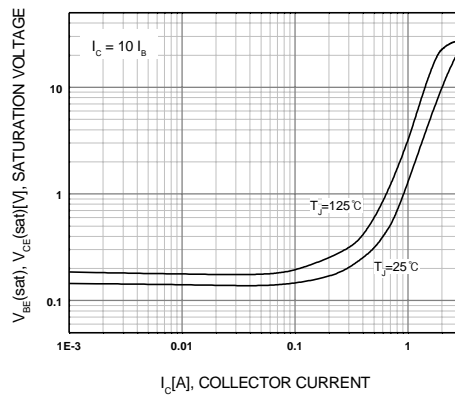

Figure 6. Collector-Emitter Saturation Voltage

Typical Characteristics (Continued)

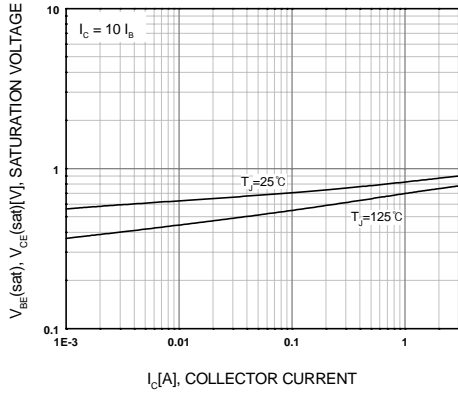

Figure 7. Base-Emitter Saturation Voltage

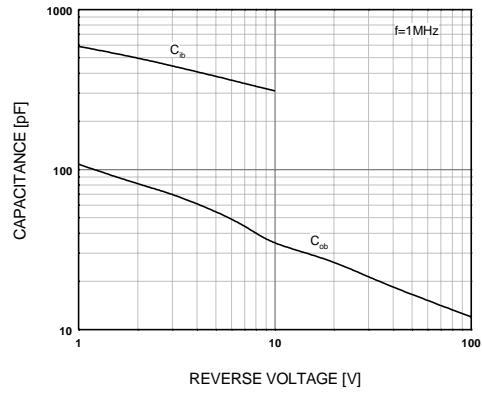

Figure 8. Collector Output Capacitance

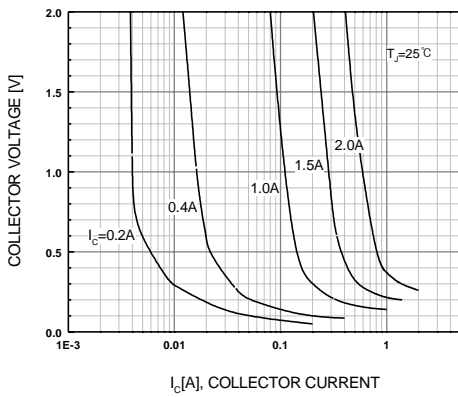

Figure 9. Typical Collector Saturation Region

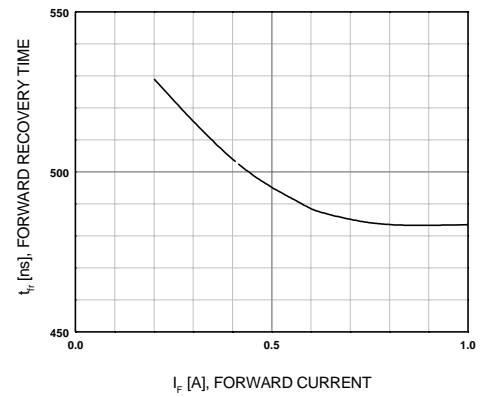

Figure 10. Forward Recovery Time

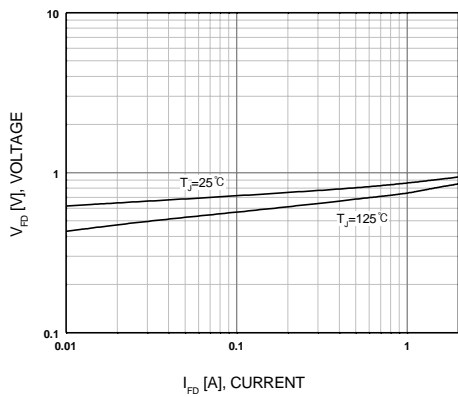

Figure 11. Diode Forward Voltage

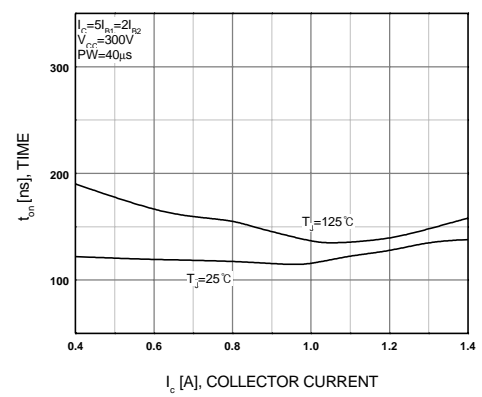

Figure 12. Resistive Switching Time, t_{on}

Typical Characteristics (Continued)

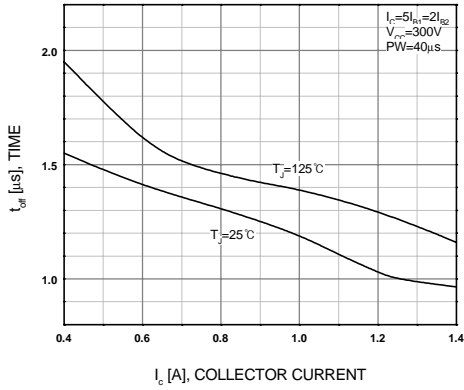

Figure 13. Resistive Switching Time, t_{off}

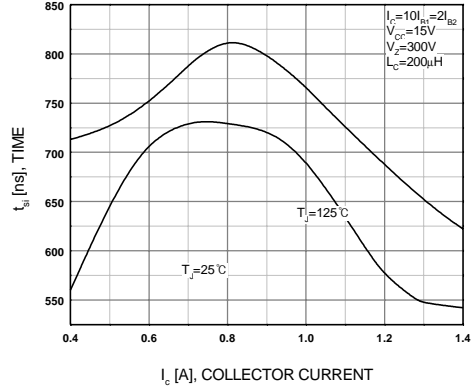

Figure 14. Inductive Switching Time, t_{si}

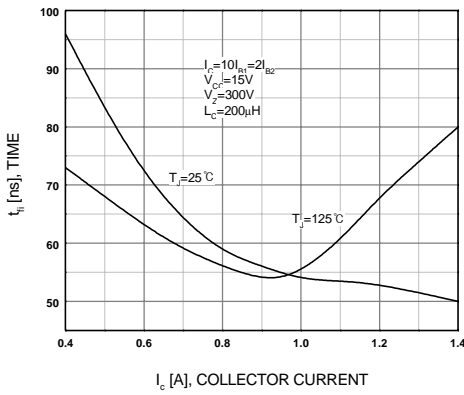

Figure 15. Inductive Switching Time, t_{fi}

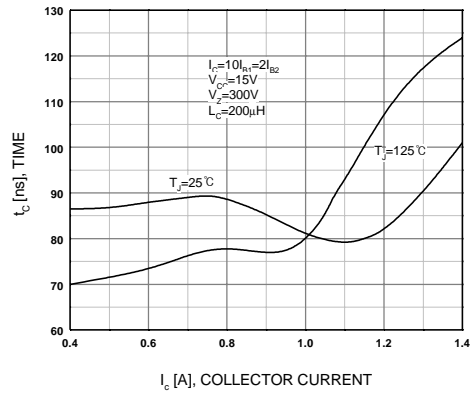

Figure 16. Inductive Switching Time, t_c

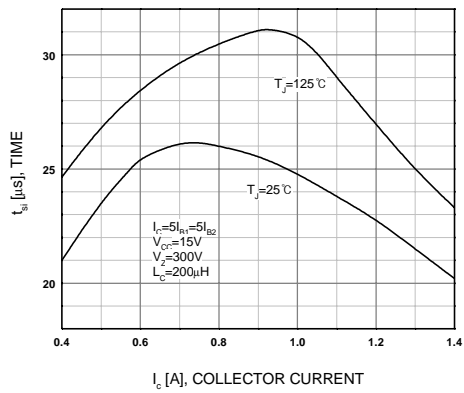

Figure 17. Inductive Switching Time, t_{si}

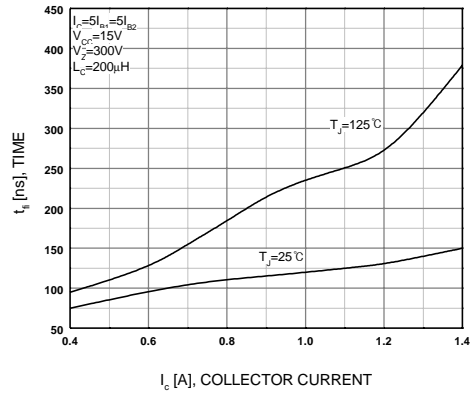

Figure 18. Inductive Switching Time, t_{fi}

Typical Characteristics (Continued)

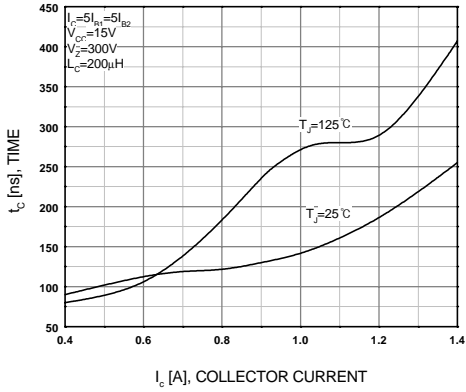

Figure 19. Inductive Switching Time, t_c

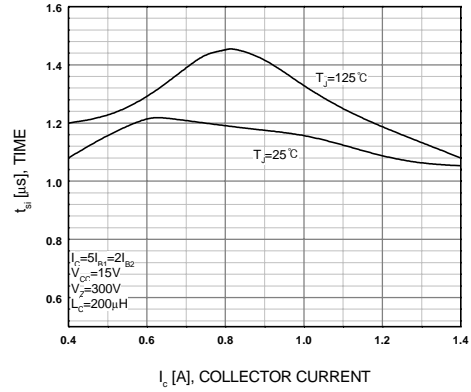

Figure 20. Inductive Switching Time, t_{si}

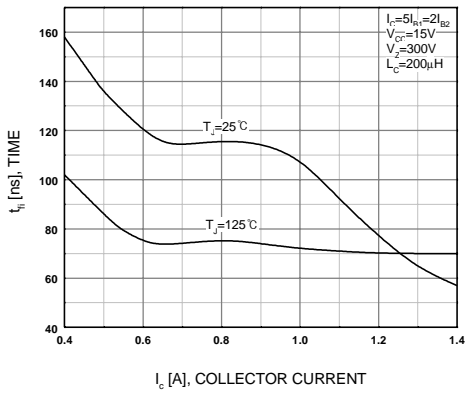

Figure 21. Inductive Switching Time, t_{fi}

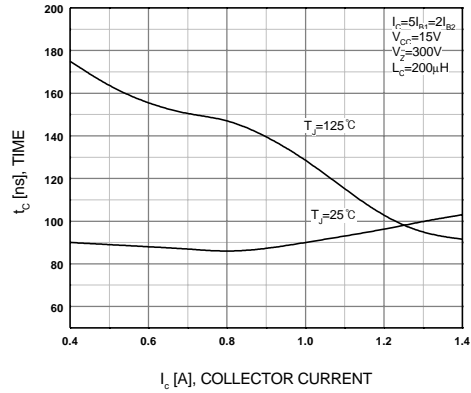

Figure 22. Inductive Switching Time, t_c

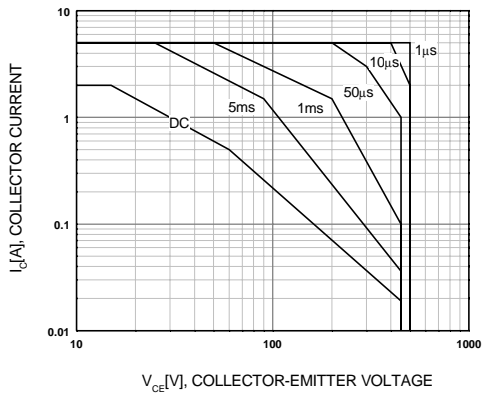

Figure 23. Forward Bias Safe Operating Area

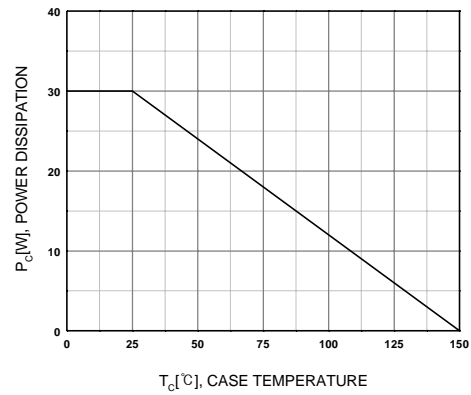
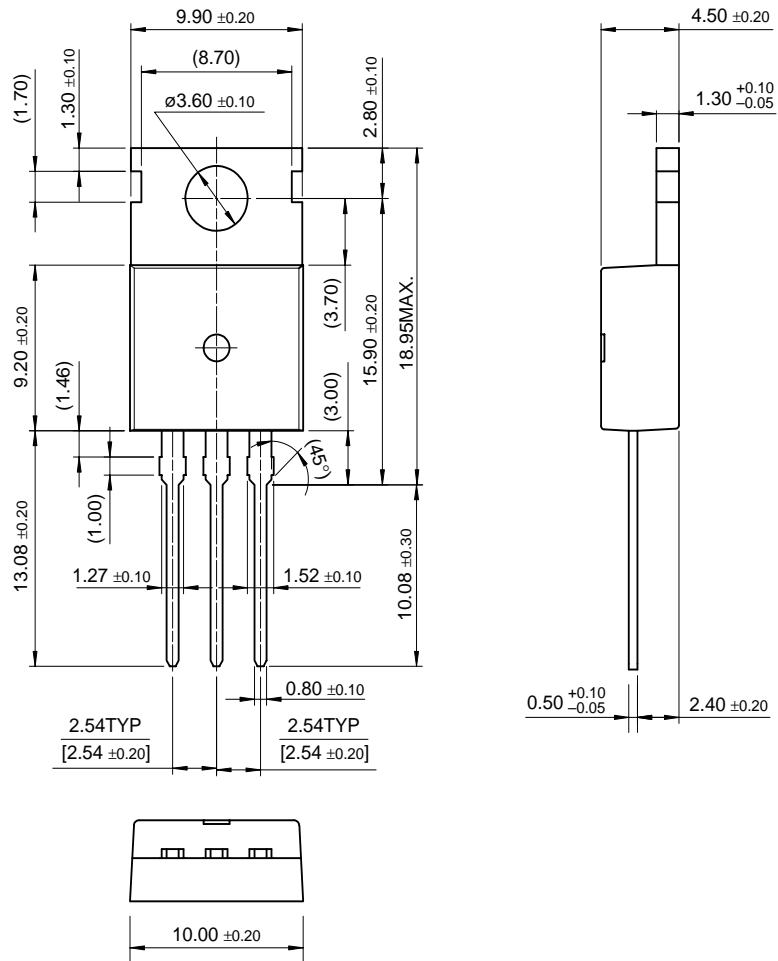

Figure 24. Power Derating

Package Dimensions

TO-220



Dimensions in Millimeters

KSC5402D/KSC5402DT

TRADEMARKS

The following are registered and unregistered trademarks Fairchild Semiconductor owns or is authorized to use and is not intended to be an exhaustive list of all such trademarks.

ACE [™]	FACT [™]	ImpliedDisconnect [™]	PACMAN [™]	SPM [™]
ActiveArray [™]	FACT Quiet series [™]	ISOPLANAR [™]	POP [™]	Stealth [™]
Bottomless [™]	FAST [®]	LittleFET [™]	Power247 [™]	SuperSOT [™] -3
CoolFET [™]	FAST ^r [™]	MicroFET [™]	PowerTrench [®]	SuperSOT [™] -6
CROSSVOLT [™]	FRFET [™]	MicroPak [™]	QFET [™]	SuperSOT [™] -8
DOMET [™]	GlobalOptoisolator [™]	MICROWIRE [™]	QS [™]	SyncFET [™]
EcoSPARK [™]	GTO [™]	MSX [™]	QT Optoelectronics [™]	TinyLogic [™]
E ² CMOS [™]	HiSeC [™]	MSXPro [™]	Quiet Series [™]	TruTranslation [™]
EnSigna [™]	I ² C [™]	OCX [™]	RapidConfigure [™]	UHC [™]
Across the board. Around the world. [™]		OCXPro [™]	RapidConnect [™]	UltraFET [®]
The Power Franchise [™]		OPTOLOGIC [®]	SILENT SWITCHER [®]	VCX [™]
Programmable Active Droop [™]		OPTOPLANAR [™]	SMART START [™]	

DISCLAIMER

FAIRCHILD SEMICONDUCTOR RESERVES THE RIGHT TO MAKE CHANGES WITHOUT FURTHER NOTICE TO ANY PRODUCTS HEREIN TO IMPROVE RELIABILITY, FUNCTION OR DESIGN. FAIRCHILD DOES NOT ASSUME ANY LIABILITY ARISING OUT OF THE APPLICATION OR USE OF ANY PRODUCT OR CIRCUIT DESCRIBED HEREIN; NEITHER DOES IT CONVEY ANY LICENSE UNDER ITS PATENT RIGHTS, NOR THE RIGHTS OF OTHERS.

LIFE SUPPORT POLICY

FAIRCHILD'S PRODUCTS ARE NOT AUTHORIZED FOR USE AS CRITICAL COMPONENTS IN LIFE SUPPORT DEVICES OR SYSTEMS WITHOUT THE EXPRESS WRITTEN APPROVAL OF FAIRCHILD SEMICONDUCTOR INTERNATIONAL.

As used herein:

1. Life support devices or systems are devices or systems which, (a) are intended for surgical implant into the body, or (b) support or sustain life, or (c) whose failure to perform when properly used in accordance with instructions for use provided in the labeling, can be reasonably expected to result in significant injury to the user.
2. A critical component is any component of a life support device or system whose failure to perform can be reasonably expected to cause the failure of the life support device or system, or to affect its safety or effectiveness.

PRODUCT STATUS DEFINITIONS

Definition of Terms

Datasheet Identification	Product Status	Definition
Advance Information	Formative or In Design	This datasheet contains the design specifications for product development. Specifications may change in any manner without notice.
Preliminary	First Production	This datasheet contains preliminary data, and supplementary data will be published at a later date. Fairchild Semiconductor reserves the right to make changes at any time without notice in order to improve design.
No Identification Needed	Full Production	This datasheet contains final specifications. Fairchild Semiconductor reserves the right to make changes at any time without notice in order to improve design.
Obsolete	Not In Production	This datasheet contains specifications on a product that has been discontinued by Fairchild semiconductor. The datasheet is printed for reference information only.