

NPN Silicon High Voltage Switching Transistors

BUX 86
BUX 87

SIEMENS AKTIENGESELLSCHAFT

BUX 86 and BUX 87 are NPN silicon epibase power switching transistors in TO 126 plastic package (12 A 3 DIN 41 869). They are outstanding for their short switching times and high dielectric strength and are particularly suitable for use in switching power supplies of TV sets. The collector is electrically connected to the metallic mounting area.

Type	Ordering code
BUX 86	Q68000-A3870
BUX 87	Q68000-A5167

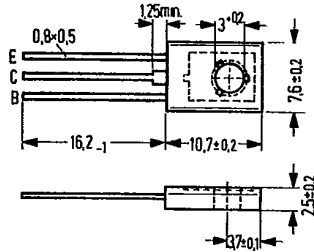

Approx. weight 0.5 g Dimensions in mm

Maximum ratings

	BUX 86	BUX 87	
Collector-emitter voltage	V_{CES} 800	1000	V
Collector-emitter voltage	V_{CEO} 400	450	V
Collector current	I_C 0.5	0.5	A
Collector peak current ($t_p \leq 2$ ms)	I_{CM} 1.0	1.0	A
Base current	I_B 0.2	0.2	A
Base peak current	I_{BM} 0.3	0.3	A
Negative base peak current at turning off	$-I_{BM}$ 0.3	0.3	A
Storage temperature range	T_{stg} -65 to +150		°C
Junction temperature	T_j 150	150	°C
Total power dissipation ($T_{case} \leq 60^\circ\text{C}$)	P_{tot} 20	20	W

Thermal resistance

Junction to mounting area	R_{thJC} ≤ 4.5	≤ 4.5	K/W
---------------------------	-----------------------	------------	-----

SIEMENS AKTIENGESELLSCHAFT

Static characteristics ($T_{amb} = 25^{\circ}\text{C}$)

		BUX 86	BUX 87	
Collector-emitter breakdown voltage ($I_C = 100\text{ mA}$; $I_B = 0$; $L = 25\text{ mH}$)	$V_{(BR)CEO}$	≥ 400	≥ 450	V
Collector cutoff current ($V_{CES} = 800\text{ V}$)	I_{CES}	< 0.1	-	mA
($V_{CES} = 800\text{ V}$; $T_j = 150^{\circ}\text{C}$)	I_{CES}	< 1	-	mA
($V_{CES} = 1000\text{ V}$)	I_{CES}	-	< 0.1	mA
($V_{CES} = 1000\text{ V}$; $T_j = 150^{\circ}\text{C}$)	I_{CES}	-	< 1	mA
Emitter cutoff current ($V_{EBO} = 5\text{ V}$)	I_{EBO}	< 1	< 1	mA
DC current gain ($V_{CE} = 5\text{ V}$; $I_C = 50\text{ mA}$)	h_{FE}	50	50	-
Collector-emitter saturation voltage ($I_C = 100\text{ mA}$; $I_B = 10\text{ mA}$)	V_{CEsat}	< 1.5	< 1.5	V
($I_C = 200\text{ mA}$; $I_B = 20\text{ mA}$)	V_{CEsat}	< 3	< 3	V
Base-emitter saturation voltage ($I_C = 200\text{ mA}$; $I_B = 20\text{ mA}$)	V_{BEsat}	< 1	< 1	V

Dynamic characteristics ($T_{amb} = 25^{\circ}\text{C}$)

Transition frequency ($V_{CE} = 10\text{ V}$; $I_C = 50\text{ mA}$; $f = 1\text{ MHz}$)	f_T	20	20	MHz
Switching times ($V_{CC} = 250\text{ V}$; $I_C = 200\text{ mA}$; $I_B = 20\text{ mA}$; $-I_B = 40\text{ mA}$)				
Turn-on time	t_{on}	0.25 (< 0.5)	0.25 (< 0.5)	μs
Storage time	t_s	2 (< 3.5)	2 (< 3.5)	μs
Fall time ¹⁾	t_f	0.4	0.4	μs

1) at $T_{case} = 95^{\circ}\text{C}$ is $t_f \leq 1.4\ \mu\text{s}$

SIEMENS AKTIENGESELLSCHAFT

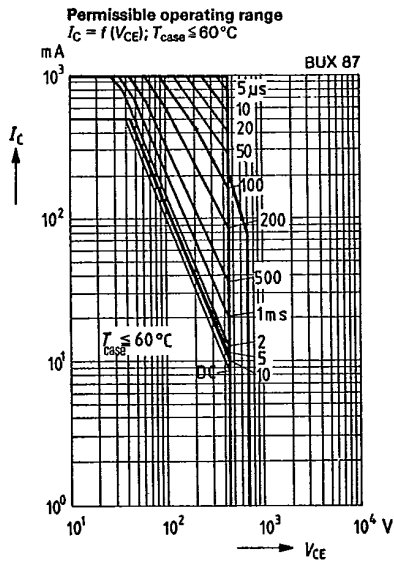
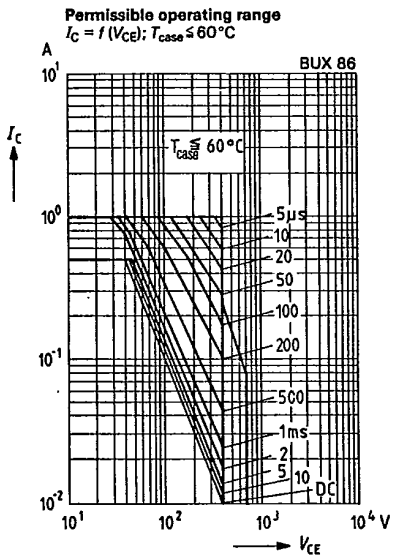
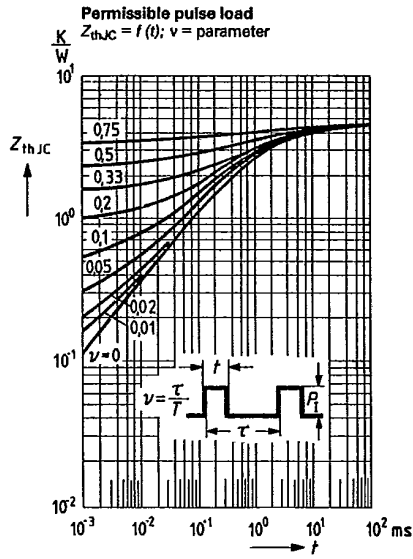
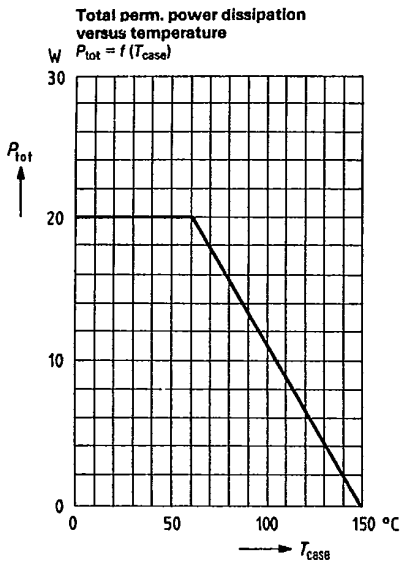

SIEMENS AKTIENGESELLSCHAFT

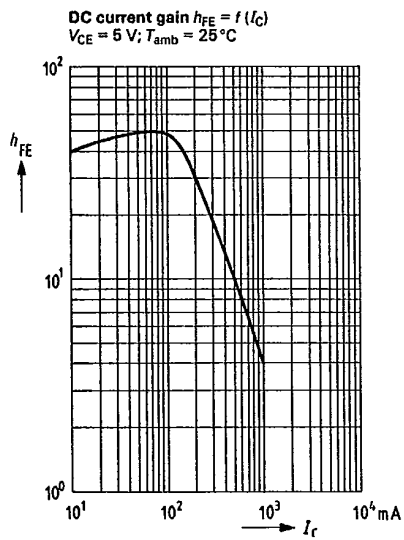

Test circuit for breakdown voltage $V_{(BR)CEO}$

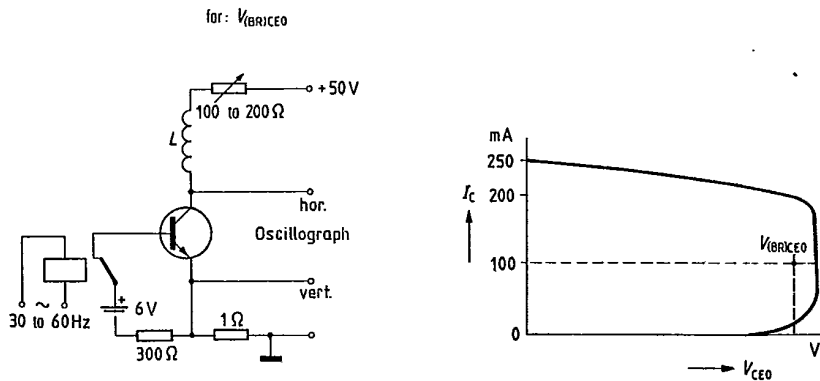

- SIEMENS AKTIENGESELLSCHAFT

Test circuit for switching times

