

NEC
ELECTRON DEVICE

MOS FIELD EFFECT TRANSISTOR

2SK720A

FAST SWITCHING
N-CHANNEL SILICON POWER MOS FET

PACKAGE DIMENSIONS
(Unit: mm)

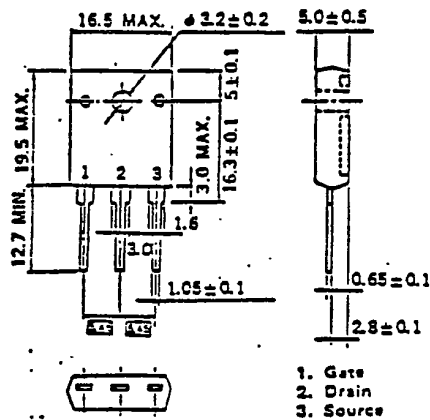

Features

- Suitable for switching power supplies, DC-DC converters and pulse circuits
- High speed switching
- Low RDS(on)
- No second breakdown

Absolute Maximum Ratings (Ta=25°C)

Drain to Source Voltage	V _{DSS}	250V
Gate to Source Voltage	V _{GSS}	± 20V
Continuous Drain Current	I _D (DC)	± 20A
Pulse Drain Current	I _D (pulse)	± 80A
Total Power Dissipation	P _T	3.0W
Total Power Dissipation	P _T **	120W
Channel Temperature	T _{ch}	150 °C
Storage Temperature	T _{stg}	-55 to +150 °C

* PW ≤ 100 μs, Duty Cycles ≤ 2 %
** T_c = 25 °C

Electrical Characteristics (Ta=25 °C)

Characteristics	Symbol	Min.	Typ.	Max.	Unit	Test Conditions
Drain Leakage Current	I _{DSS}			100	μA	V _D =250V, V _G =0
Gate to Source Leakage Current	I _{GSS}			±100	nA	V _G =±20V, V _D =0
Gate to Source Cutoff Voltage	V _G (off)	1.5		3.5	V	V _D =10V, I _D =1.0mA
Forward Transfer Admittance	y _{fs}	5.0			S	V _D =10V, I _D =10A
Drain to Source On-State Resistance	R _{DS(on)}		0.18	0.23	Ω	V _G =10V, I _D =10A
Input Capacitance	C _{iss}		1900		pF	V _D =10V,
Output Capacitance	C _{oss}		630		pF	V _G =0,
Reverse Transfer Capacitance	C _{rss}		320		pF	f=1.0MHz
Turn-On Delay Time	t _d (on)		30		ns	I _D =10A,
Rise Time	t _r		45		ns	V _G (on)=10V,
Turn-Off Delay Time	t _d (off)		120		ns	V _{CC} =150V,
Fall Time	t _f		40		ns	R _L =15 Ω

2SK720A

NEC ELECTRON DEVICE

TURN-ON AND TURN-OFF TIME TEST CIRCUIT

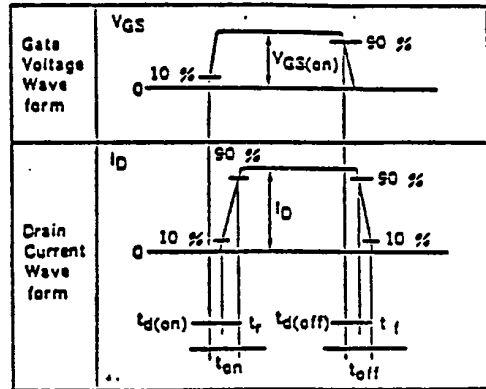
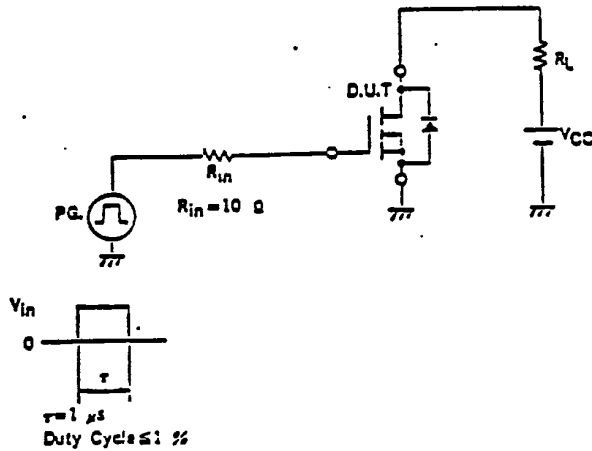

DERATING FACTOR OF FORWARD BIAS SAFE OPERATING AREA

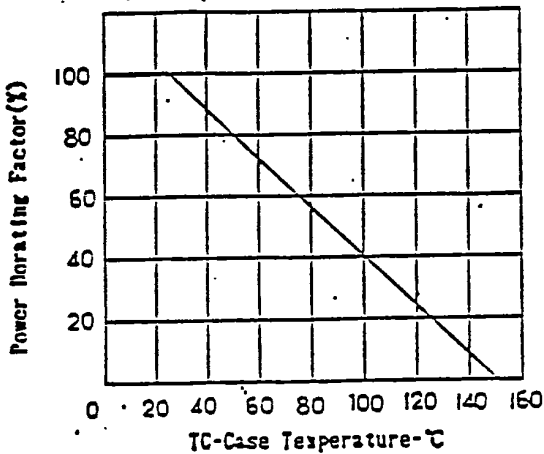

FORWARD BIAS SAFE OPERATING AREA

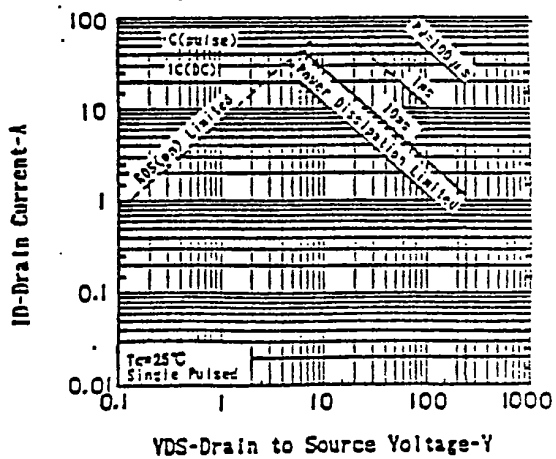

TOTAL POWER DISSIPATION vs. CASE TEMPERATURE

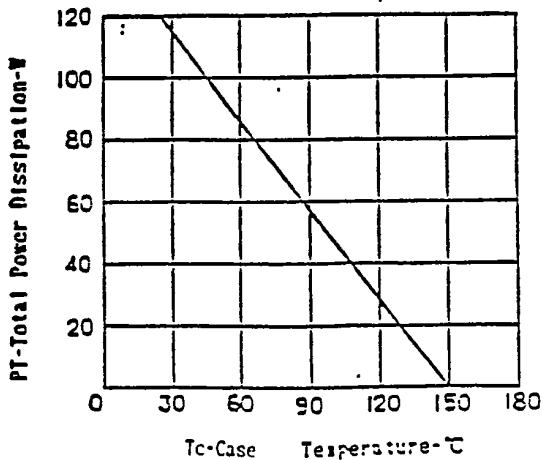

DRAIN CURRENT vs. DRAIN TO SOURCE VOLTAGE

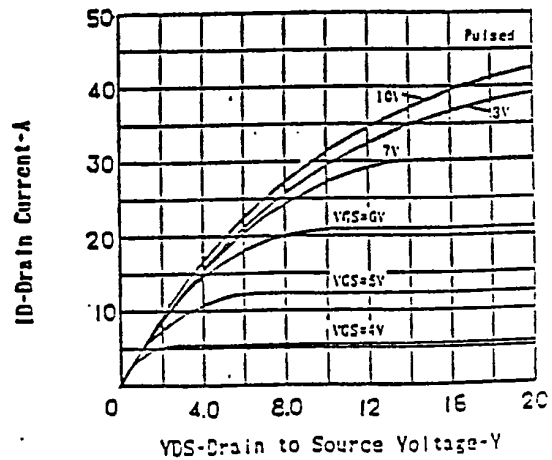

NEC ELECTRON DEVICE 2SK720A

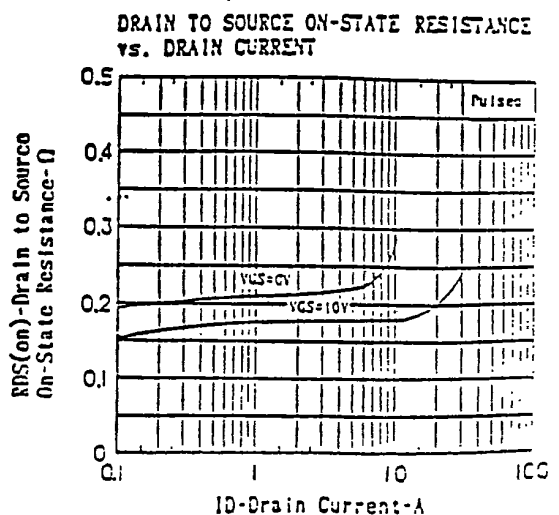
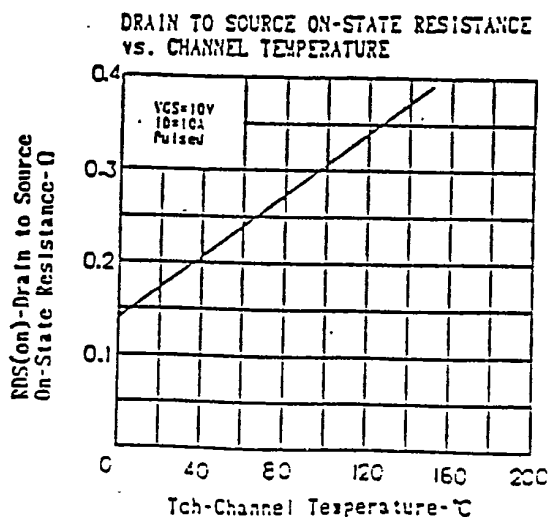
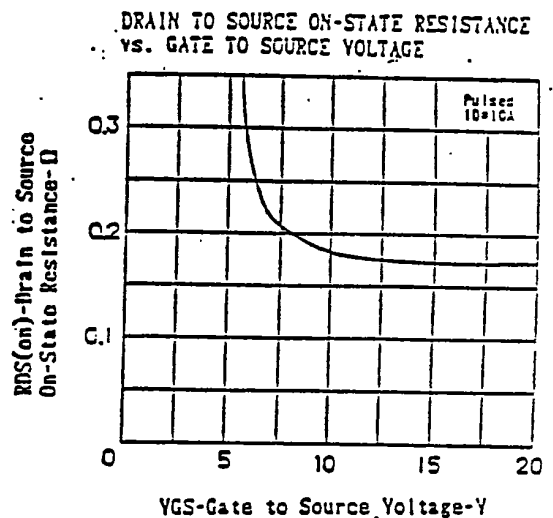
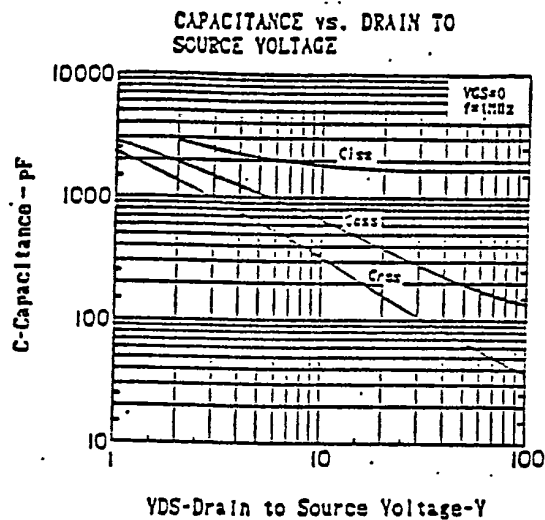
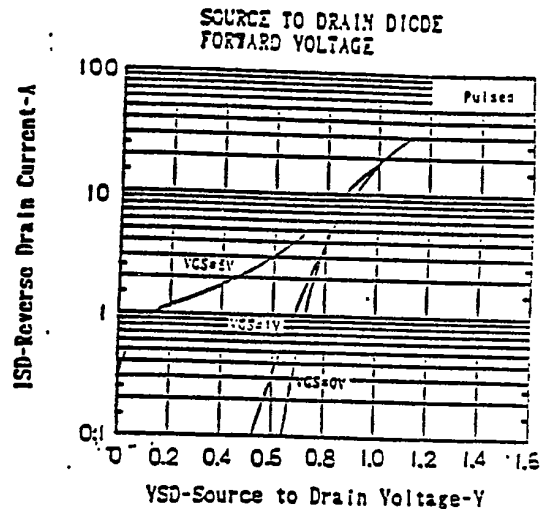
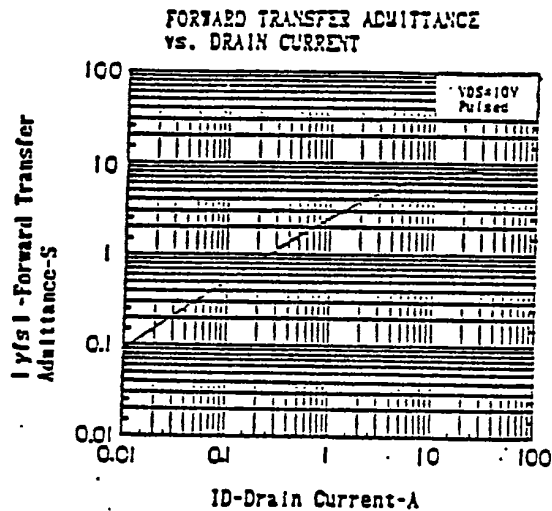

2SK720A

NEC ELECTRON DEVICE

TRANSFER CHARACTERISTICS

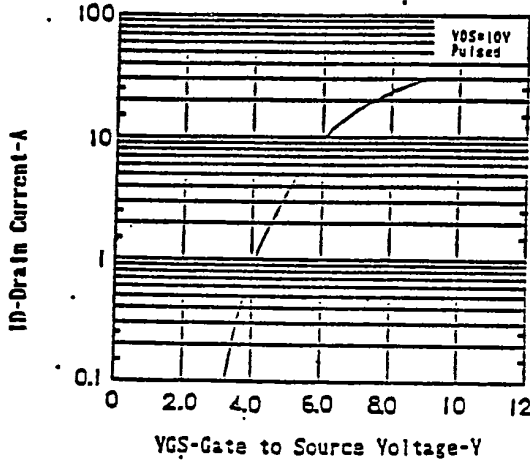

GATE TO SOURCE CUTOFF VOLTAGE vs. CHANNEL TEMPERATURE

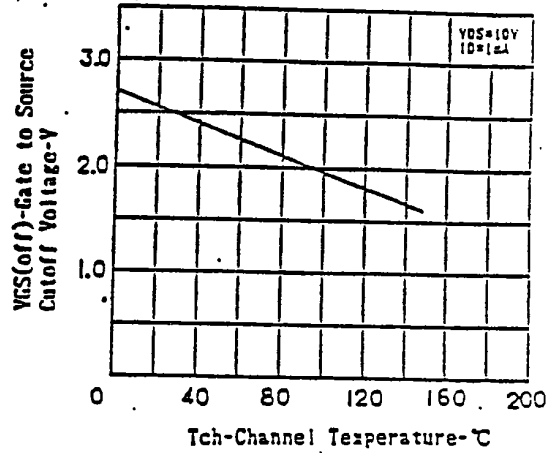

TURN-ON AND TURN-OFF TIME

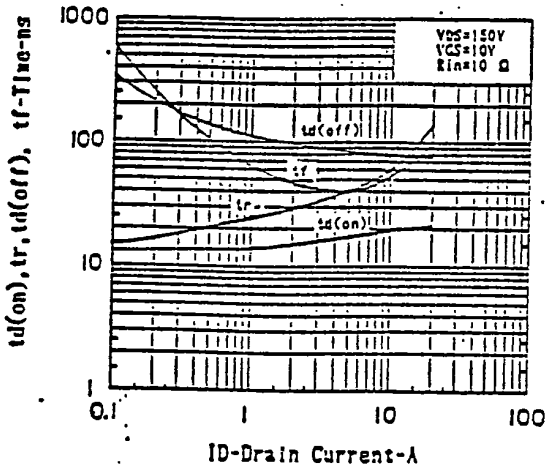

NEC Corporation

INTERNATIONAL ELECTRON DEVICES DIV.
 NEC Building, 33-1, Shiba Gochome
 Minato-ku, Tokyo 108, Japan
 Tel: Tokyo 454-1111
 Telex Address: NECTOK J22626
 Cable Address: MICROPHONE TOKYO