

MOS FIELD EFFECT TRANSISTOR
2SK2481

SWITCHING
 N-CHANNEL POWER MOS FET
 INDUSTRIAL USE

DESCRIPTION

The 2SK2481 is N-Channel MOS Field Effect Transistor designed for high voltage switching applications.

FEATURES

- Low On-Resistance
 $R_{DS(on)} = 4.0 \Omega$ ($V_{GS} = 10 V, I_D = 2.0 A$)
- Low C_{iss} $C_{iss} = 900 pF$ TYP.
- High Avalanche Capability Ratings

ABSOLUTE MAXIMUM RATINGS ($T_A = 25^\circ C$)

| | | | |
|--|----------------|-------------|------------|
| Drain to Source Voltage | V_{DSS} | 900 | V |
| Gate to Source Voltage | V_{GSS} | ± 30 | V |
| Drain Current (DC) | $I_{D(DC)}$ | ± 4.0 | A |
| Drain Current (pulse)* | $I_{D(pulse)}$ | ± 12 | A |
| Total Power Dissipation ($T_c = 25^\circ C$) | P_{T1} | 70 | W |
| Total Power Dissipation ($T_A = 25^\circ C$) | P_{T2} | 1.5 | W |
| Channel Temperature | T_{ch} | 150 | $^\circ C$ |
| Storage Temperature | T_{stg} | -55 to +150 | $^\circ C$ |
| Single Avalanche Current** | I_{AS} | 4.0 | A |
| Single Avalanche Energy** | E_{AS} | 65.9 | mJ |

* $PW \leq 10 \mu s$, Duty Cycle $\leq 1\%$

** Starting $T_{ch} = 25^\circ C$, $R_G = 25 \Omega$, $V_{GS} = 20 V \rightarrow 0$

PACKAGE DIMENSIONS

(in millimeters)

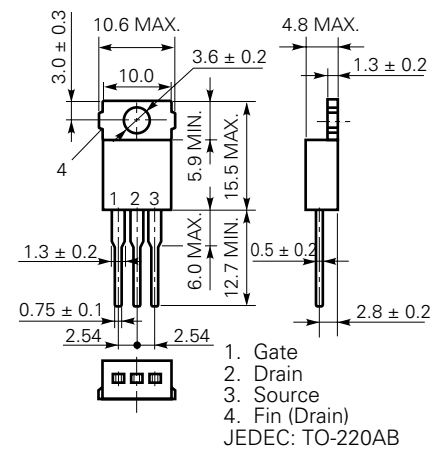

MP-25 (TO-220)

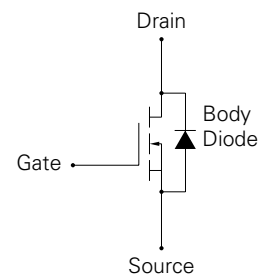

ELECTRICAL CHARACTERISTICS (T_A = 25 °C)

| CHARACTERISTIC | SYMBOL | MIN. | TYP. | MAX. | UNIT | TEST CONDITIONS |
|-------------------------------------|----------------------|------|------|------|------|--|
| Drain to Source On-State Resistance | R _{DS(on)} | | 3.2 | 4.0 | Ω | V _{GS} = 10 V, I _D = 2.0 A |
| Gate to Source Cutoff Voltage | V _{GS(off)} | 2.5 | | 3.5 | V | V _{DS} = 10 V, I _D = 1 mA |
| Forward Transfer Admittance | y _{fs} | 1.0 | | | S | V _{DS} = 20 V, I _D = 2.0 A |
| Drain Leakage Current | I _{DSS} | | | 100 | μA | V _{DS} = V _{DSS} , V _{GS} = 0 |
| Gate to Source Leakage Current | I _{GSS} | | | ±100 | nA | V _{GS} = ±30 V, V _{DS} = 0 |
| Input Capacitance | C _{iss} | | 900 | | pF | V _{DS} = 10 V |
| Output Capacitance | C _{oss} | | 130 | | pF | V _{GS} = 0 |
| Reverse Transfer Capacitance | C _{rss} | | 25 | | pF | f = 1 MHz |
| Turn-On Delay Time | t _{d(on)} | | 17 | | ns | I _D = 2.0 A |
| Rise Time | t _r | | 7 | | ns | V _{GS} = 10 V |
| Turn-Off Delay Time | t _{d(off)} | | 63 | | ns | V _{DD} = 150 V |
| Fall Time | t _f | | 8 | | ns | R _G = 10 Ω |
| Total Gate Charge | Q _G | | 30 | | nC | I _D = 4.0 A |
| Gate to Source Charge | Q _{GS} | | 5 | | nC | V _{DD} = 450 V |
| Gate to Drain Charge | Q _{GD} | | 13 | | nC | V _{GS} = 10 V |
| Body Diode Forward Voltage | V _{F(S-D)} | | 1.0 | | V | I _F = 4.0 A, V _{GS} = 0 |
| Reverse Recovery Time | t _{rr} | | 710 | | ns | I _F = 4.0 A, V _{GS} = 0 |
| Reverse Recovery Charge | Q _{rr} | | 3.5 | | μC | di/dt = 50 A/μs |

Test Circuit 1 Avalanche Capability

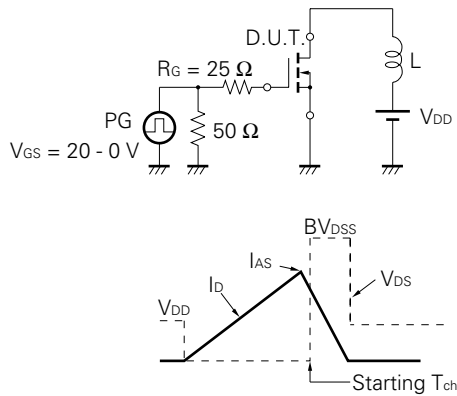

Test Circuit 2 Switching Time

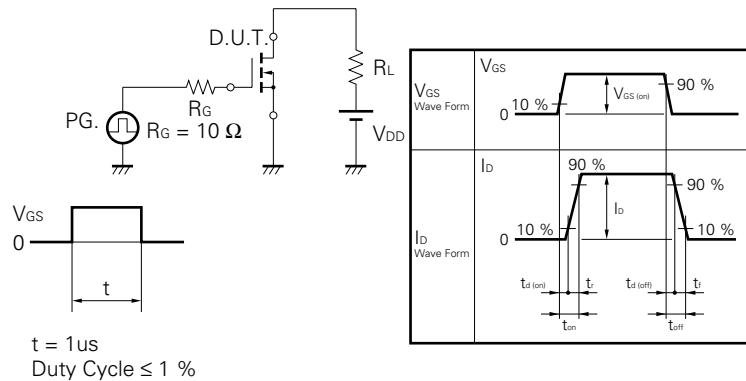

Test Circuit 3 Gate Charge

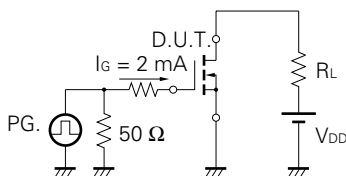

The application circuits and their parameters are for references only and are not intended for use in actual design-in's.

TYPICAL CHARACTERISTICS (T_A = 25 °C)

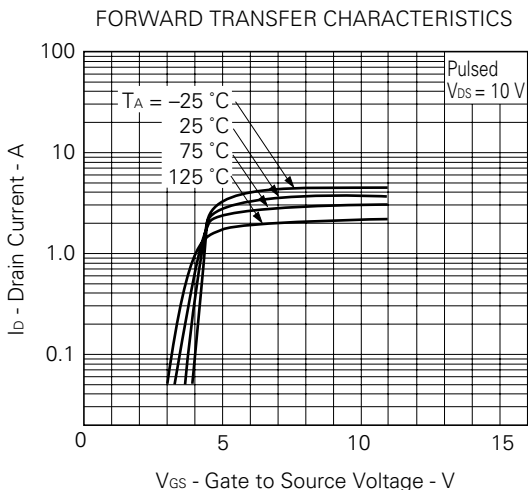
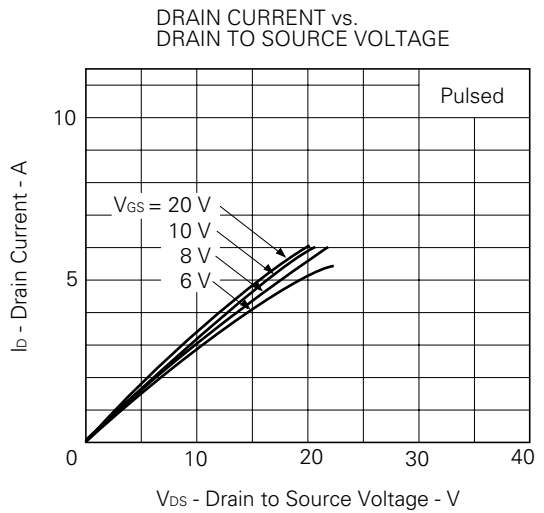
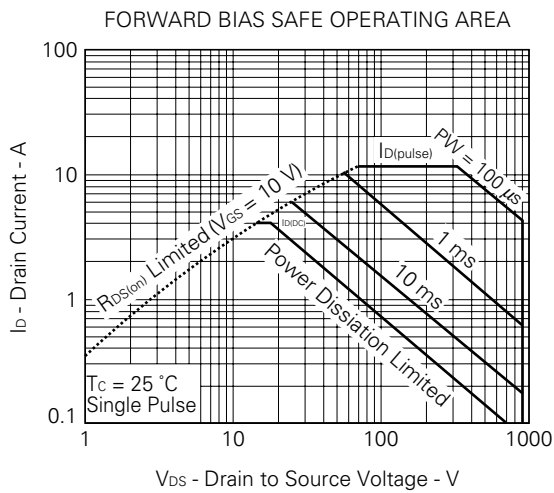
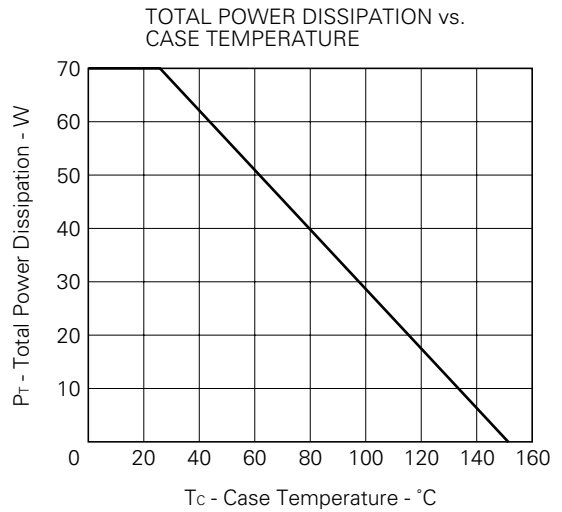
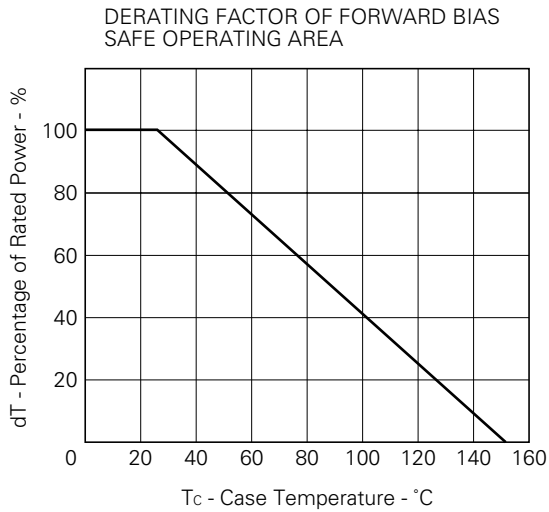

TRANSIENT THERMAL RESISTANCE vs. PULSE WIDTH

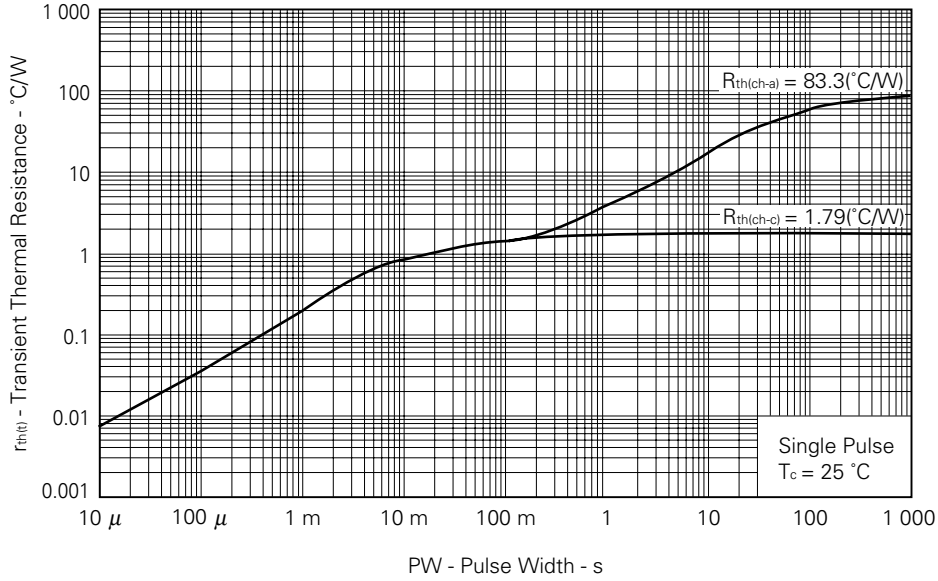

FORWARD TRANSFER ADMITTANCE vs. DRAIN CURRENT

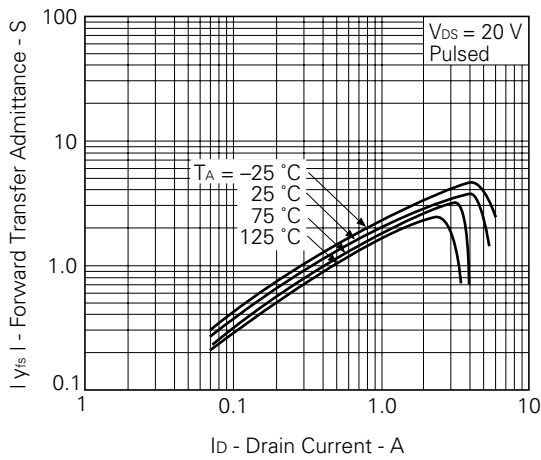

DRAIN TO SOURCE ON-STATE RESISTANCE vs. GATE TO SOURCE VOLTAGE

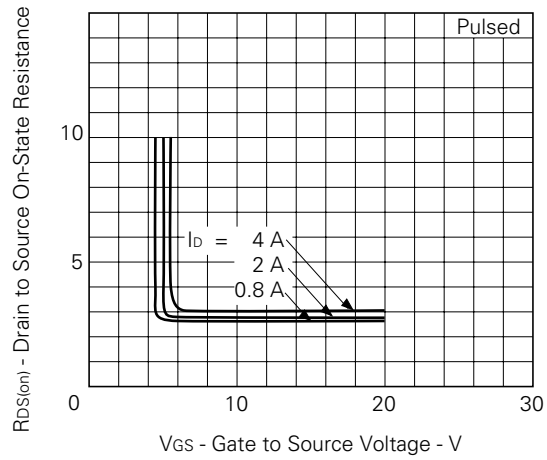

DRAIN TO SOURCE ON-STATE RESISTANCE vs. DRAIN CURRENT

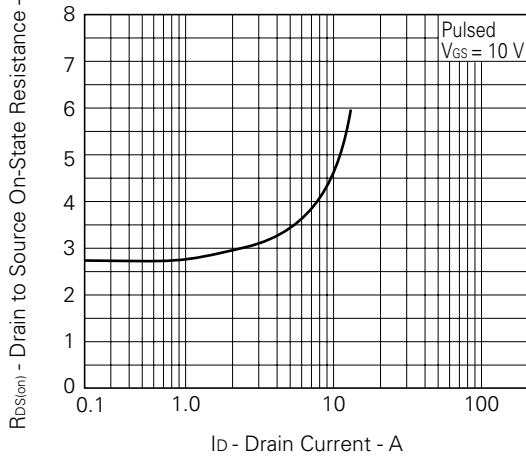

GATE TO SOURCE CUTOFF VOLTAGE vs. CHANNEL TEMPERATURE

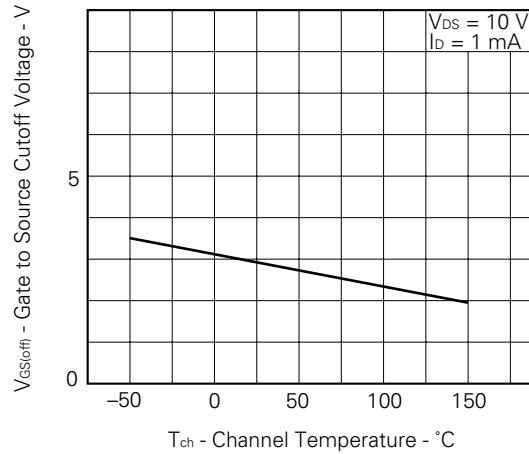

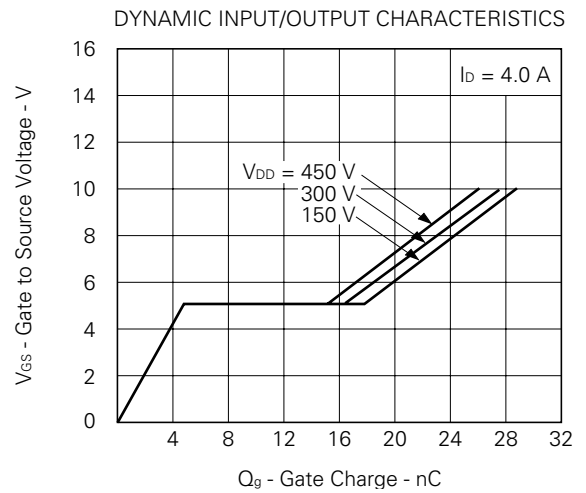
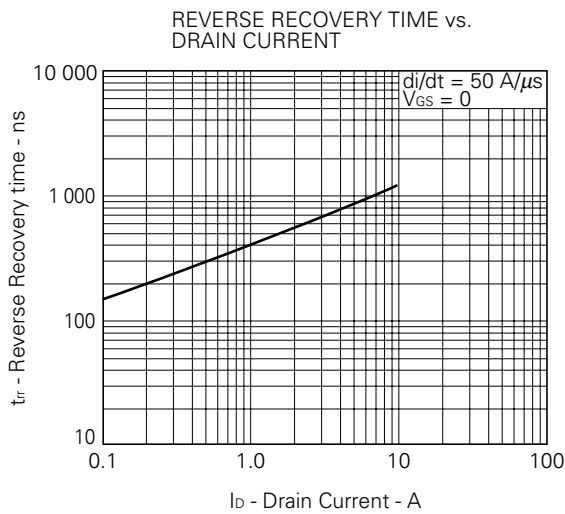
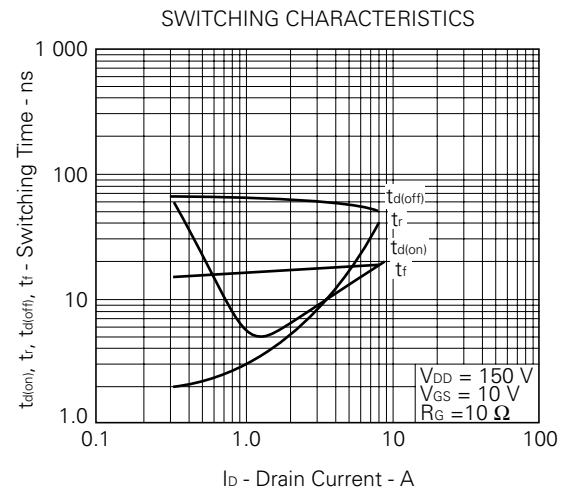
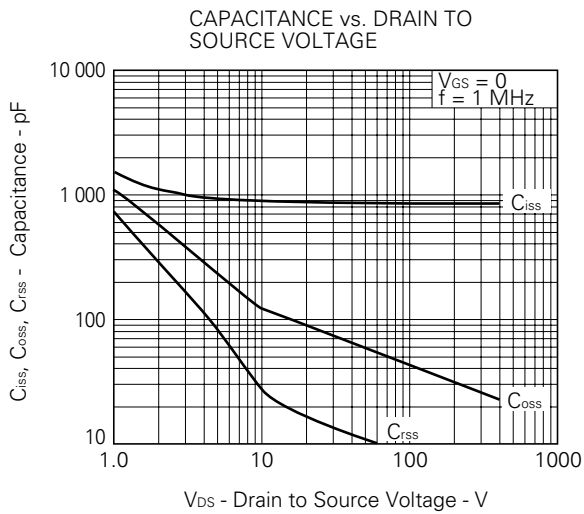
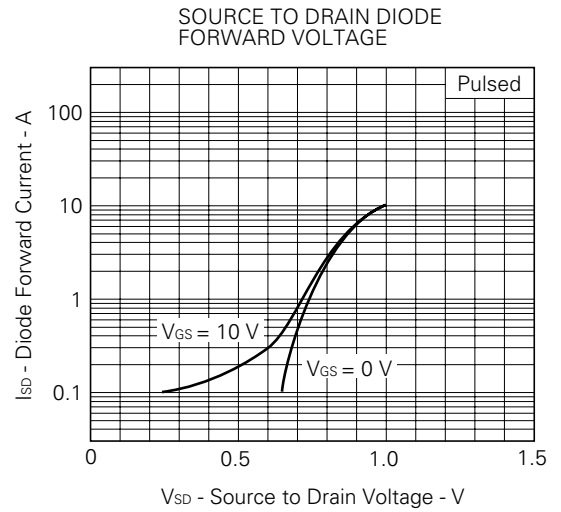
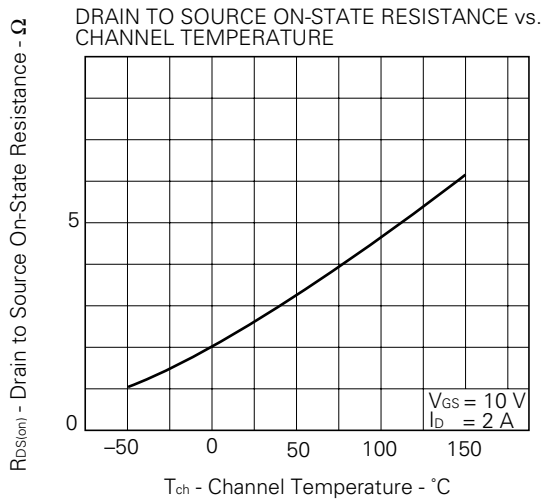

SINGLE AVALANCHE CURRENT vs. INDUCTIVE LOAD

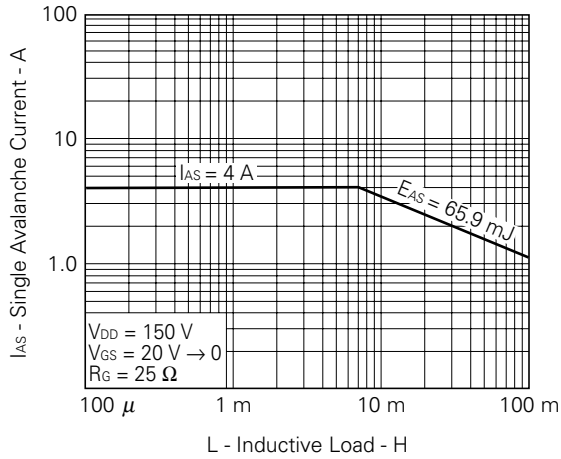

SINGLE AVALANCHE ENERGY DERATING FACTOR

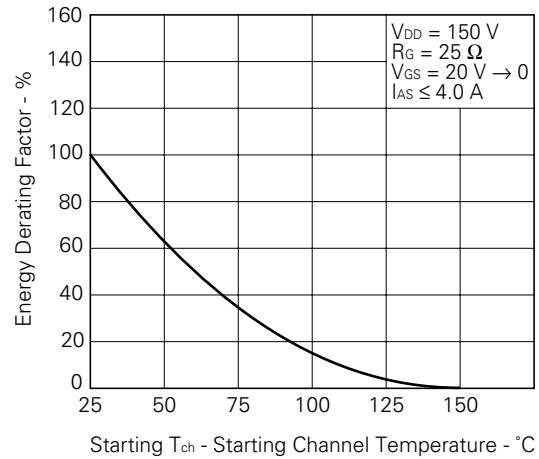

REFERENCE

| Document Name | Document No. |
|--|--------------|
| NEC semiconductor device reliability/quality control system. | TEI-1202 |
| Quality grade on NEC semiconductor devices. | IEI-1209 |
| Semiconductor device mounting technology manual. | IEI-1207 |
| Semiconductor device package manual. | IEI-1213 |
| Guide to quality assurance for semiconductor devices. | MEI-1202 |
| Semiconductor selection guide. | MF-1134 |
| Power MOS FET features and application switching power supply. | TEA-1034 |
| Application circuits using Power MOS FET. | TEA-1035 |
| Safe operating area of Power MOS FET. | TEA-1037 |

[MEMO]

No part of this document may be copied or reproduced in any form or by any means without the prior written consent of NEC Corporation. NEC Corporation assumes no responsibility for any errors which may appear in this document.

NEC Corporation does not assume any liability for infringement of patents, copyrights or other intellectual property rights of third parties by or arising from use of a device described herein or any other liability arising from use of such device. No license, either express, implied or otherwise, is granted under any patents, copyrights or other intellectual property rights of NEC Corporation or others.

While NEC Corporation has been making continuous effort to enhance the reliability of its semiconductor devices, the possibility of defects cannot be eliminated entirely. To minimize risks of damage or injury to persons or property arising from a defect in an NEC semiconductor device, customer must incorporate sufficient safety measures in its design, such as redundancy, fire-containment, and anti-failure features.

NEC devices are classified into the following three quality grades:

“Standard”, “Special”, and “Specific”. The Specific quality grade applies only to devices developed based on a customer designated “quality assurance program” for a specific application. The recommended applications of a device depend on its quality grade, as indicated below. Customers must check the quality grade of each device before using it in a particular application.

Standard: Computers, office equipment, communications equipment, test and measurement equipment, audio and visual equipment, home electronic appliances, machine tools, personal electronic equipment and industrial robots

Special: Transportation equipment (automobiles, trains, ships, etc.), traffic control systems, anti-disaster systems, anti-crime systems, safety equipment and medical equipment (not specifically designed for life support)

Specific: Aircrafts, aerospace equipment, submersible repeaters, nuclear reactor control systems, life support systems or medical equipment for life support, etc.

The quality grade of NEC devices in “Standard” unless otherwise specified in NEC's Data Sheets or Data Books. If customers intend to use NEC devices for applications other than those specified for Standard quality grade, they should contact NEC Sales Representative in advance.

Anti-radioactive design is not implemented in this product.