

9097250 TOSHIBA (DISCRETE/OPTO)

56C 07841 DT=33-13

# 2SD878

SILICON NPN TRIPLE DIFFUSED TYPE

HIGH POWER AMPLIFIER APPLICATIONS.  
 HIGH POWER SWITCHING APPLICATIONS.  
 DC-DC CONVERTER APPLICATIONS.  
 REGULATOR APPLICATIONS.

FEATURES:

- High Power Dissipation :  $P_C=115W$  ( $T_c=25^\circ C$ )
- High Collector Current :  $I_C=15A$
- Low Saturation Voltage :  $V_{CE(sat)}=0.3V$  (Typ.) ( $I_C=4A$ )

MAXIMUM RATINGS ( $T_a=25^\circ C$ )

CHARACTERISTIC	SYMBOL	RATING	UNIT
Collector-Base Voltage	VCBO	100	V
Collector-Emitter Voltage	VCEO	60	V
Emitter-Base Voltage	VEBO	7	V
Collector Current	IC	15	A
Base Current	IB	7	A
Collector Power Dissipation ( $T_c=25^\circ C$ )	PC	115	W
Junction Temperature	Tj	175	°C
Storage Temperature Range	Tstg	-65~175	°C

INDUSTRIAL APPLICATIONS

Unit in mm

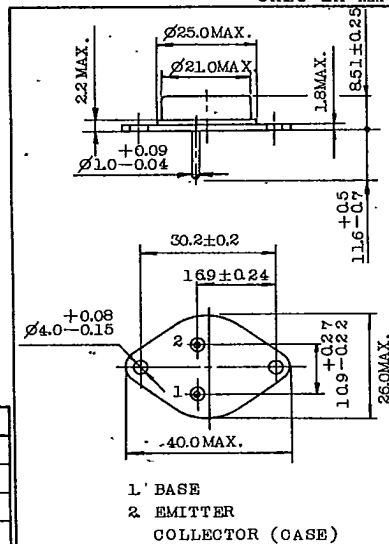

JEDEC	TO-204MA/TO-3
EIAJ	TO-3, TB-3
TOSHIBA	2-21D1A

Mounting Kit No. AC73  
 Weight : 12.6g

ELECTRICAL CHARACTERISTICS ( $T_a=25^\circ C$ )

CHARACTERISTIC	SYMBOL	TEST CONDITION	MIN.	TYP.	MAX.	UNIT
Collector Cut-off Current	ICBO	$V_{CB}=100V, I_E=0$	-	-	100	$\mu A$
Emitter Cut-off Current	IEBO	$V_{EB}=7V, I_C=0$	-	-	100	$\mu A$
Collector-Emitter Breakdown Voltage	$V_{(BR)CEO}$	$I_C=50mA, I_B=0$	60	-	-	V
DC Current Gain	$h_{FE(1)}$	$V_{CE}=4V, I_C=4A$	20	-	70	
	$h_{FE(2)}$	$V_{CE}=4V, I_C=10A$	5	-	-	
Collector-Emitter Saturation Voltage	$V_{CE(sat)}$	$I_C=4A, I_B=0.4A$	-	0.3	1.1	V
Base-Emitter Voltage	$V_{BE}$	$V_{CE}=4V, I_C=4A$	-	1.1	1.8	V
Transition Frequency	$f_T$	$V_{CE}=4V, I_C=1A$	-	1.5	-	MHz
Collector Output Capacitance	$C_{ob}$	$V_{CB}=10V, I_E=0, f=1MHz$	-	150	-	pF
Switching Time	Turn-on Time	$t_{on}$	-	2.5	-	$\mu s$
	Storage Time	$t_{stg}$	-	3.5	-	
	Fall Time	$t_f$	-	1.2	-	

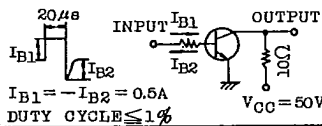

TOSHIBA CORPORATION

9097250 TOSHIBA (DISCRETE/OPTO)

56C 07842 DT-33-13

2SD878

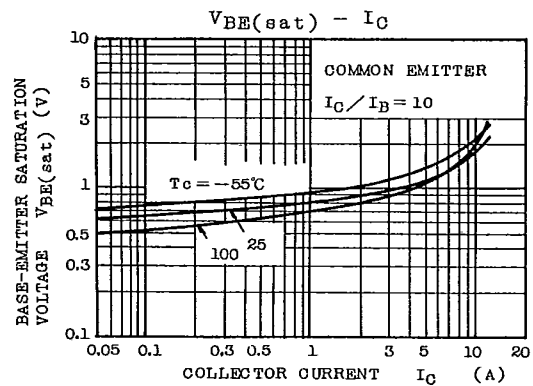
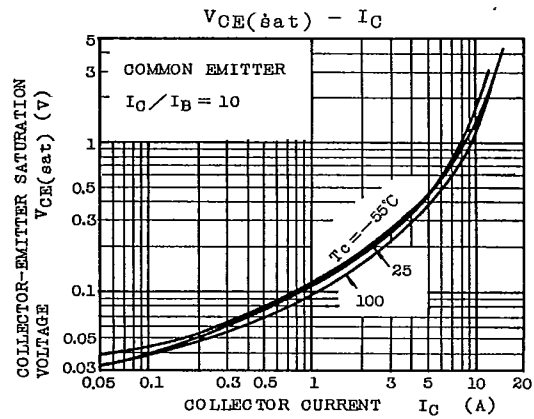
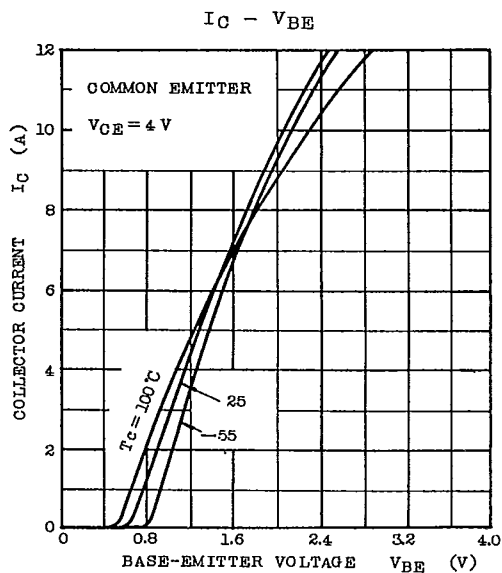
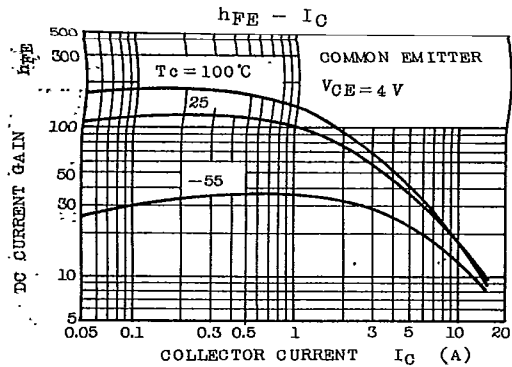
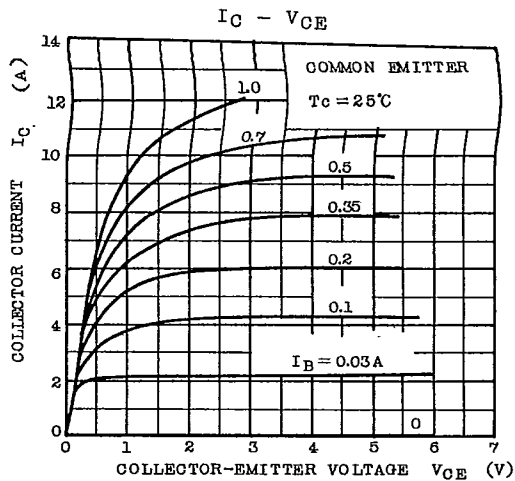

TOSHIBA CORPORATION

9097250 TOSHIBA (DISCRETE/OPTO)

56C 07843 DT-33-13

**2SD878**

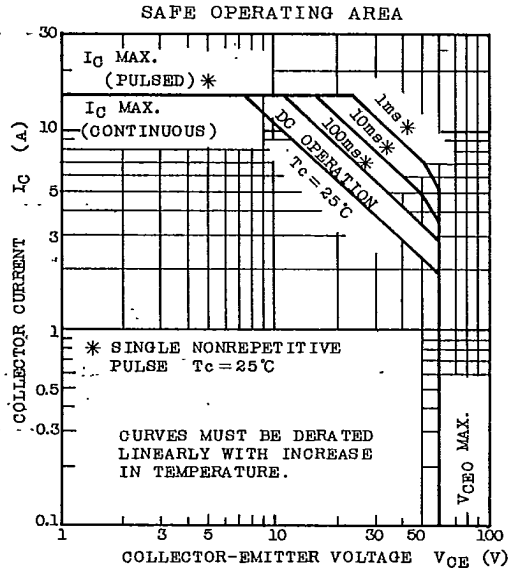
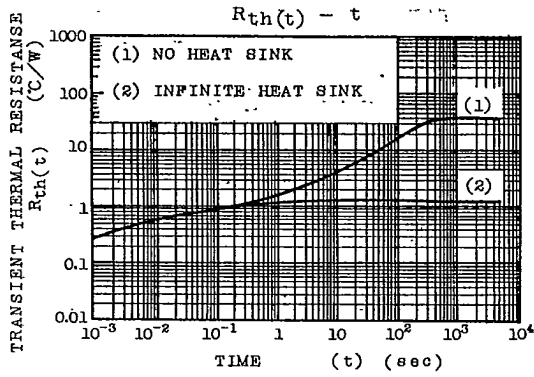

TOSHIBA CORPORATION