

T-33-11

**2SD823**

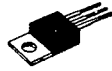

2010A

NPN Epitaxial Planar Silicon Transistor

# B/W TV Horizontal Output Applications

©542C

## Absolute Maximum Ratings at $T_a=25^\circ\text{C}$

Parameter	Symbol	Value	unit
Collector to Base Voltage	$V_{CBO}$	200	V
Collector to Emitter Voltage	$V_{CEO}$	90	V
Emitter to Base Voltage	$V_{EBO}$	7	V
Collector Current	$I_C$	6	A
Peak Collector Current	$i_{cp}$	10	A
Collector Dissipation	$P_C$	40	W
Junction Temperature	$T_j$	150	$^\circ\text{C}$
Storage Temperature	$T_{stg}$	-55 to +150	$^\circ\text{C}$

$T_C=25^\circ\text{C}$

## Electrical Characteristics at $T_a=25^\circ\text{C}$

Parameter	Symbol	Test Conditions	min	typ	max	unit
Collector Cutoff Current	$I_{CBO}$	$V_{CB}=40\text{V}, I_E=0$			0.1	mA
Emitter Cutoff Current	$I_{EBO}$	$V_{EB}=4\text{V}, I_C=0$			0.1	mA
Collector to Base Voltage	$V_{CBO}$	$I_C=5\text{mA}, I_E=0$	200			V
Collector to Emitter Voltage	$V_{CEO}$	$I_C=5\text{mA}, I_B=0$	90			V
Emitter to Base Voltage	$V_{EBO}$	$I_E=5\text{mA}, I_C=0$	7			V
DC Current Gain	$h_{FE}$	$V_{CE}=5\text{V}, I_C=3\text{V}$	20			
Gain Bandwidth Product	$f_T$	$V_{CE}=5\text{V}, I_C=1\text{A}$		15		MHz
C-E Saturation Voltage	$V_{CE(sat)}$	$I_C=5\text{A}, I_B=0.5\text{A}$			1.5	V
B-E Saturation Voltage	$V_{BE(sat)}$	$I_C=5\text{A}, I_B=0.5\text{A}$			1.5	V
Fall Time	$t_f$	$I_C=5\text{A}, I_{B1}=0.6\text{A}$			1.0	us

$t_f$  Test Circuit

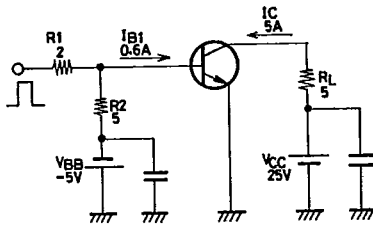

Case Outline 2010A  
(unit:mm)

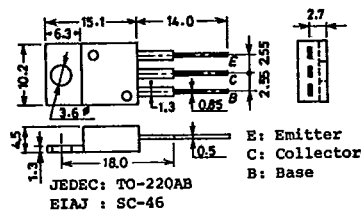

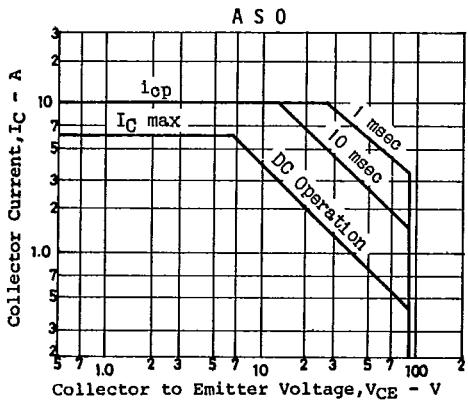
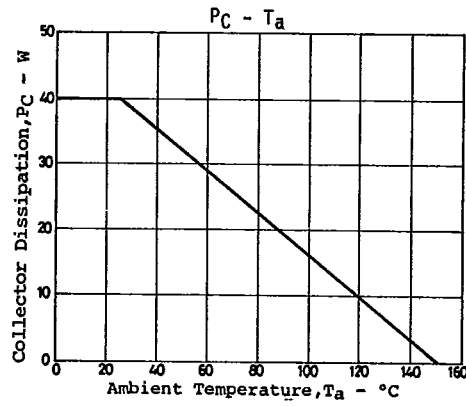
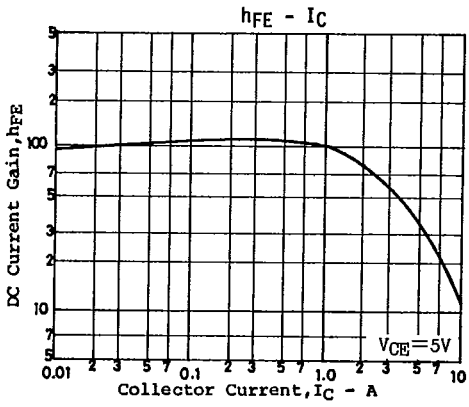
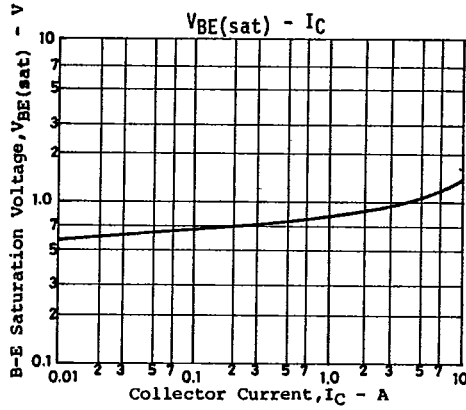
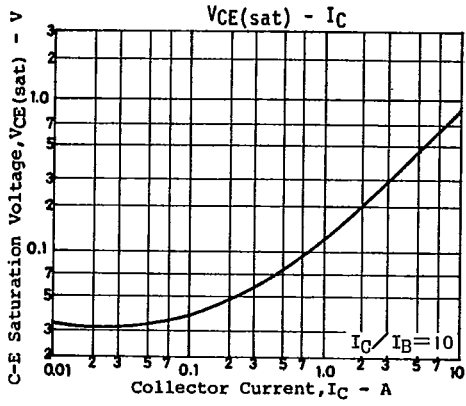

T-91-20

# CASE OUTLINES AND ATTACHMENTS

- All of Sanyo Transistor case outlines are illustrated below.
- All dimensions are in mm, and dimensions which are not followed by min. or max. are represented by typical values.
- No marking is indicated.

Case Outline-[2003A]  
unit:mm

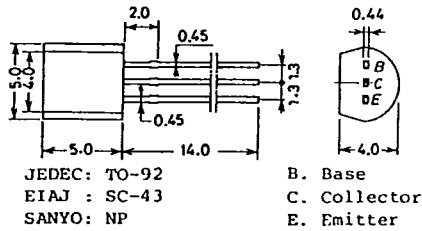

Case Outline-[2009A]  
unit:mm

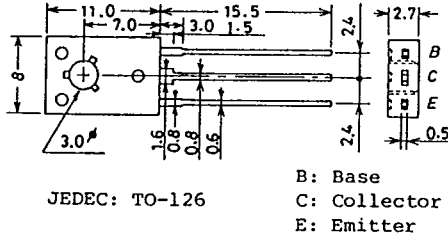

Case Outline-[2004A]  
unit:mm

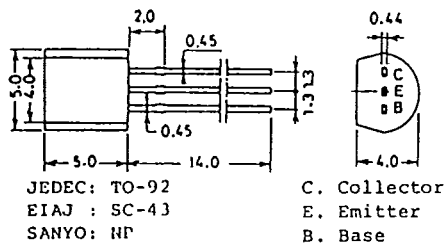

Case Outline-[2010A]  
unit:mm

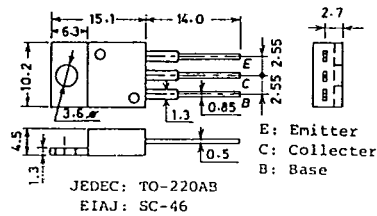

Case Outline-[2005A]  
unit:mm

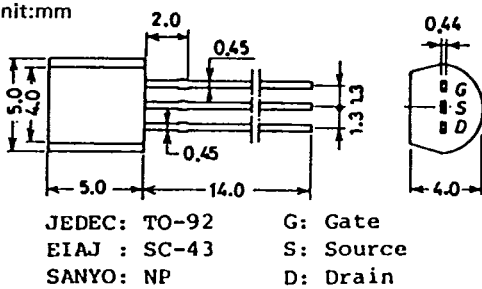

Case Outline-[2012]  
unit:mm

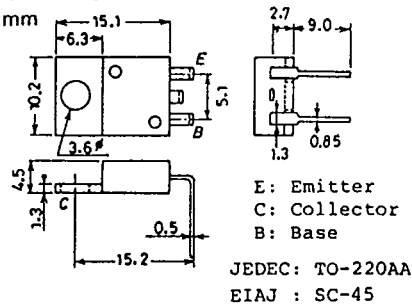

Case Outline-[2006A]  
unit:mm

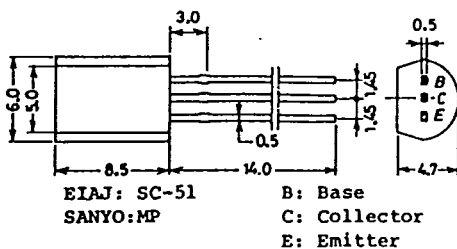

Case Outline-[2013]  
unit:mm

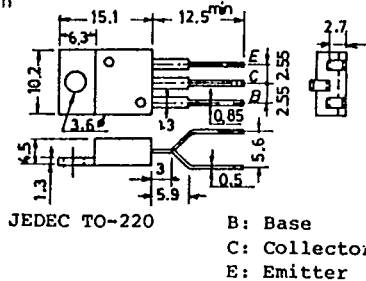





T-91-20

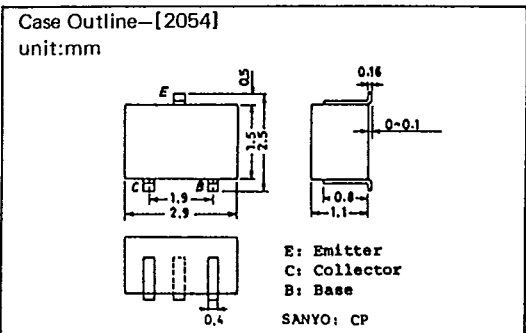
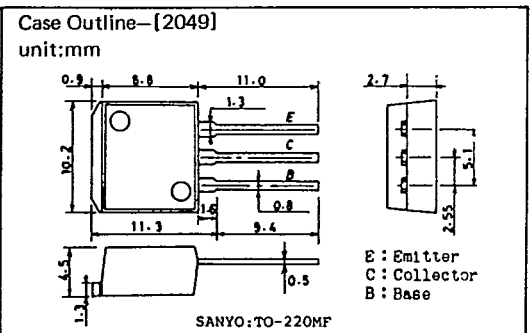
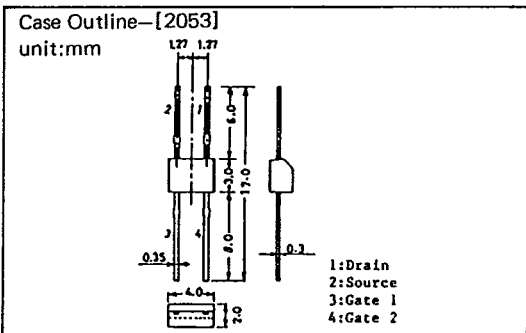
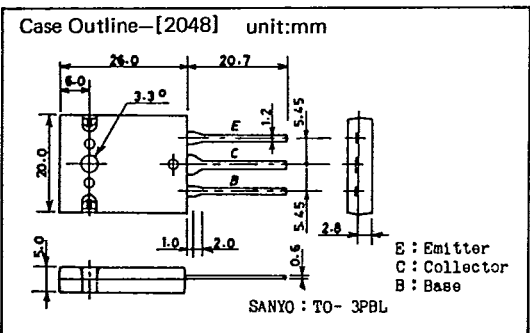
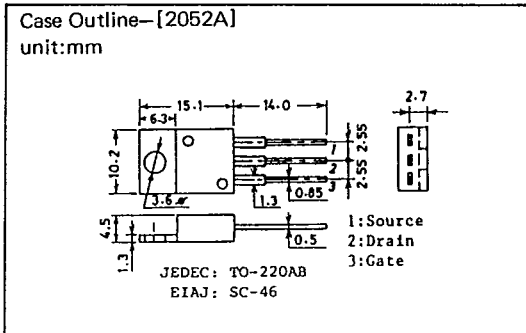
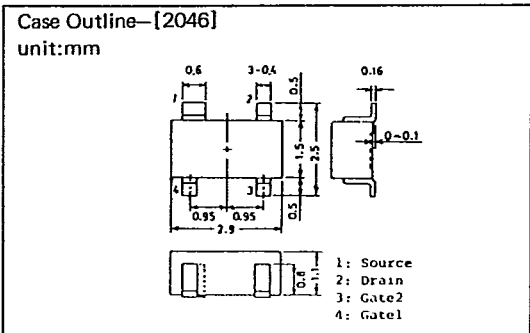
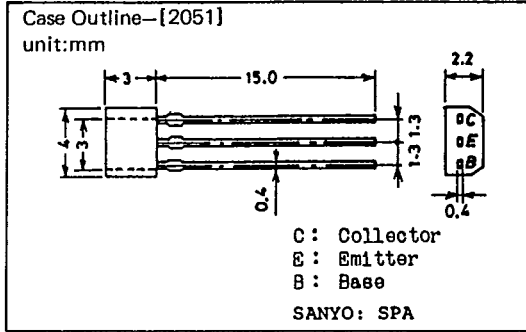
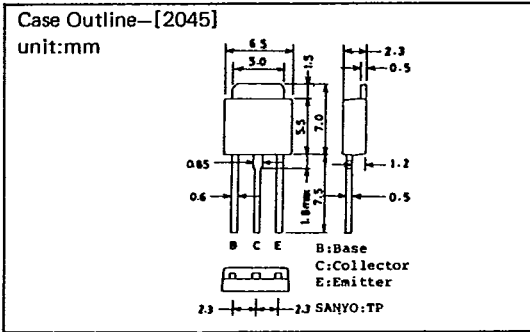
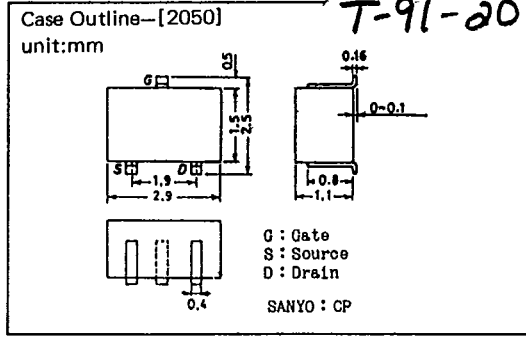
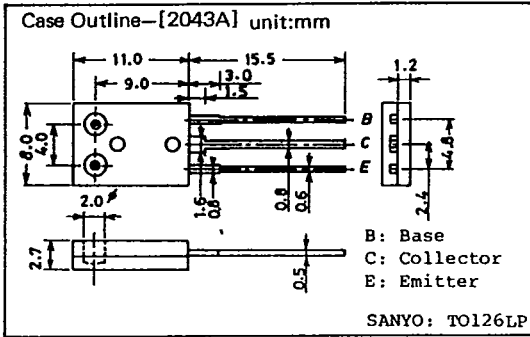

T-91-20

