

2SD2527

Silicon NPN triple diffusion planar type

For power amplification with high forward current transfer ratio

Features

- High forward current transfer ratio h_{FE}
- Satisfactory linearity of forward current transfer ratio h_{FE}
- Full-pack package which can be installed to the heat sink with one screw

Absolute Maximum Ratings ($T_C=25^\circ\text{C}$)

Parameter	Symbol	Rated	Unit
Collector to base voltage	V_{CBO}	80	V
Collector to emitter voltage	V_{CEO}	60	V
Emitter to base voltage	V_{EBO}	6	V
Peak collector current	I_{CP}	8	A
Collector current	I_C	4	A
Base current	I_B	1	A
Collector power dissipation	P_C	$T_C=25^\circ\text{C}$	40
		$T_a=25^\circ\text{C}$	2.0
Junction temperature	T_j	150	$^\circ\text{C}$
Storage temperature	T_{stg}	-55 to +150	$^\circ\text{C}$

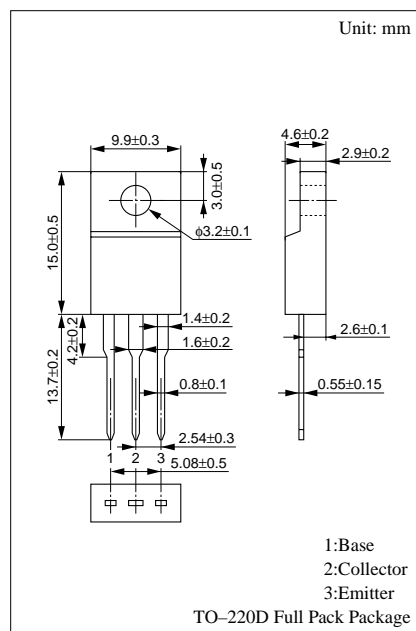

Electrical Characteristics ($T_C=25^\circ\text{C}$)

Parameter	Symbol	Conditions	min	typ	max	Unit
Collector cutoff current	I_{CBO}	$V_{CB} = 80\text{V}, I_E = 0$			100	μA
	I_{CEO}	$V_{CE} = 40\text{V}, I_B = 0$			100	μA
Emitter cutoff current	I_{EBO}	$V_{EB} = 6\text{V}, I_C = 0$			100	μA
Collector to emitter voltage	V_{CEO}	$I_C = 25\text{mA}, I_B = 0$	60			V
Forward current transfer ratio	h_{FE}^*	$V_{CE} = 4\text{V}, I_C = 0.8\text{A}$	500		2000	
Collector to emitter saturation voltage	$V_{CE(sat)}$	$I_C = 3\text{A}, I_B = 0.075\text{A}$			0.7	V
Transition frequency	f_T	$V_{CE} = 12\text{V}, I_C = 0.3\text{A}, f = 10\text{MHz}$		30		MHz
Storage time	t_{stg}	$I_C = 3\text{A}, I_{B1} = 0.06\text{A}, I_{B2} = -0.06\text{A}, V_{CC} = 50\text{V}$		20		μs

* h_{FE} Rank classification

Rank	Q	P
h_{FE}	500 to 1200	800 to 2000

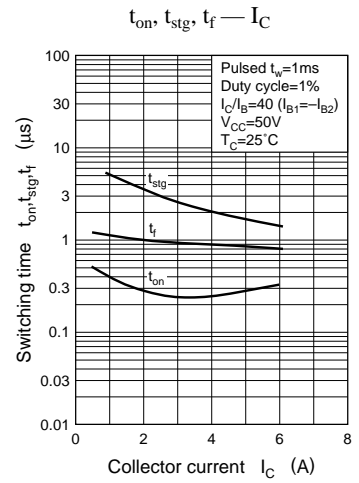
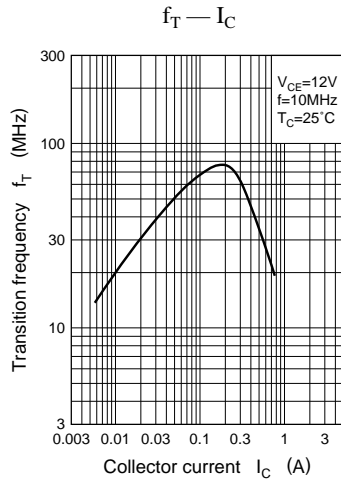
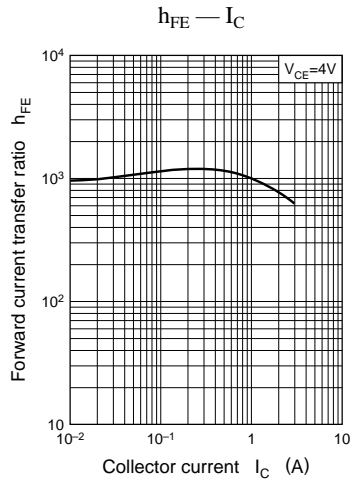
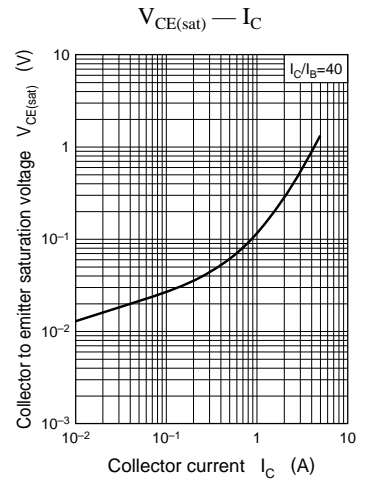
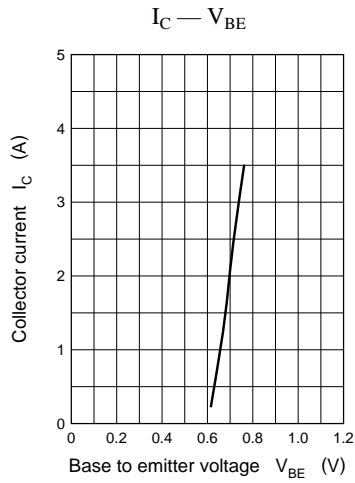
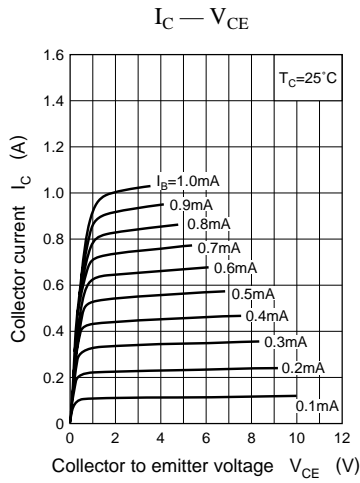

Area of safe operation (ASO)

