

2SD2467

Silicon NPN epitaxial planar type

For power switching

Features

- Low collector to emitter saturation voltage $V_{CE(sat)}$
- Satisfactory linearity of forward current transfer ratio h_{FE}
- Large collector current I_C
- Full-pack package with outstanding insulation, which can be installed to the heat sink with one screw

Absolute Maximum Ratings ($T_C=25^\circ\text{C}$)

Parameter	Symbol	Rated	Unit
Collector to base voltage	V_{CBO}	130	V
Collector to emitter voltage	V_{CEO}	80	V
Emitter to base voltage	V_{EBO}	7	V
Peak collector current	I_{CP}	6	A
Collector current	I_C	3	A
Collector power dissipation	P_C	30	W
		2	
Junction temperature	T_j	150	$^\circ\text{C}$
Storage temperature	T_{stg}	-55 to +150	$^\circ\text{C}$

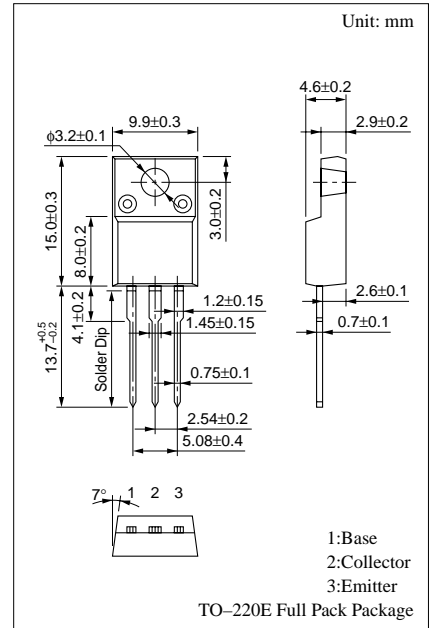

Electrical Characteristics ($T_C=25^\circ\text{C}$)

Parameter	Symbol	Conditions	min	typ	max	Unit
Collector cutoff current	I_{CBO}	$V_{CB} = 100V, I_E = 0$			10	μA
Emitter cutoff current	I_{EBO}	$V_{EB} = 5V, I_C = 0$			50	μA
Collector to emitter voltage	V_{CEO}	$I_C = 10\text{mA}, I_B = 0$	80			V
Forward current transfer ratio	h_{FE1}	$V_{CE} = 2V, I_C = 0.1A$	45			
	h_{FE2}^*	$V_{CE} = 2V, I_C = 0.5A$	90		260	
Collector to emitter saturation voltage	$V_{CE(sat)}$	$I_C = 2A, I_B = 0.1A$			0.5	V
Base to emitter saturation voltage	$V_{BE(sat)}$	$I_C = 2A, I_B = 0.1A$			1.5	V
Transition frequency	f_T	$V_{CE} = 10V, I_C = 0.5A, f = 10\text{MHz}$		30		MHz
Turn-on time	t_{on}	$I_C = 0.5A, I_{B1} = 50\text{mA}, I_{B2} = -50\text{mA}, V_{CC} = 50V$		0.5		μs
Storage time	t_{stg}			2.5		μs
Fall time	t_f				0.15	μs

* h_{FE2} Rank classification

Rank	Q	P
h_{FE2}	90 to 180	130 to 260

$P_C - T_a$

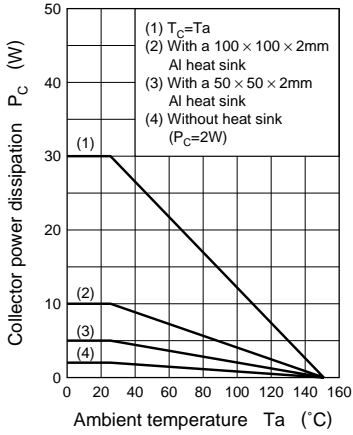

$I_C - V_{CE}$

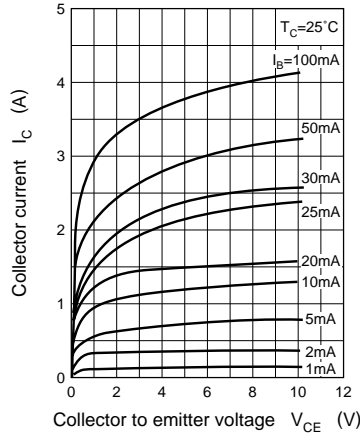

$V_{CE(sat)} - I_C$

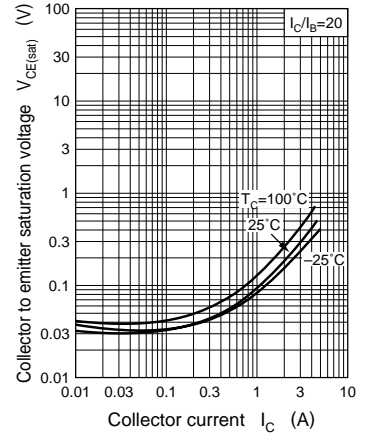

$V_{BE(sat)} - I_C$

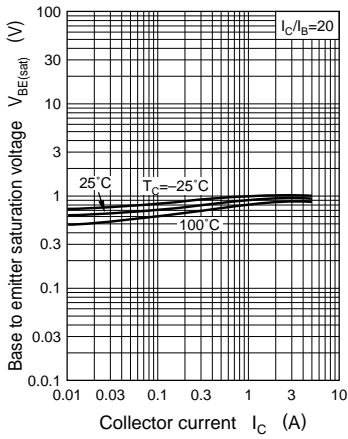

$h_{FE} - I_C$

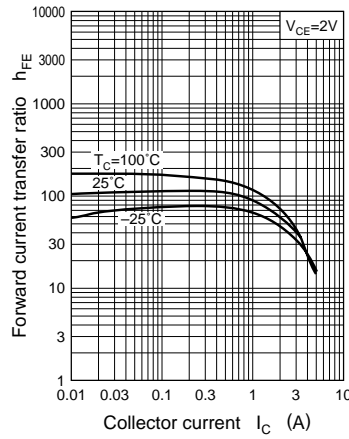

$f_T - I_C$

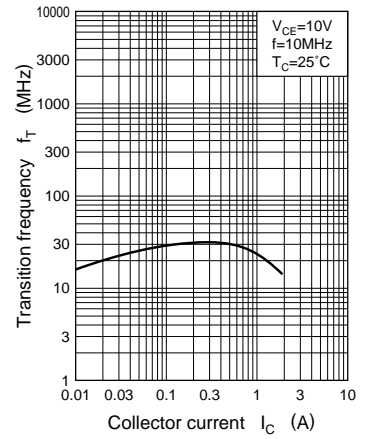

$C_{ob} - V_{CB}$

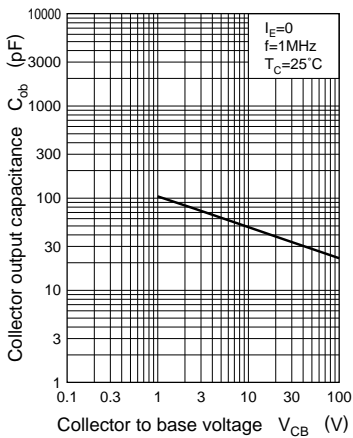

$t_{on}, t_{stg}, t_f - I_C$

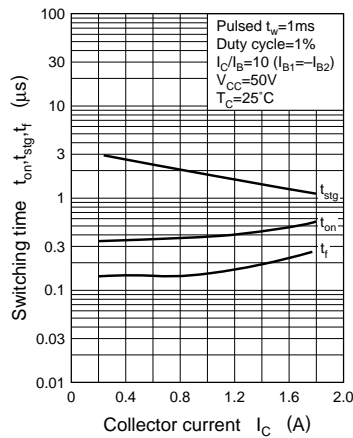

Area of safe operation (ASO)

