

2SD1996

Silicon NPN epitaxial planer type

For low-voltage output amplification

For muting

For DC-DC converter

Features

- Low collector to emitter saturation voltage $V_{CE(sat)}$.
- Low ON resistance R_{on} .
- High forward current transfer ratio h_{FE} .
- Allowing supply with the radial taping.

Absolute Maximum Ratings (Ta=25°C)

Parameter	Symbol	Ratings	Unit
Collector to base voltage	V_{CBO}	25	V
Collector to emitter voltage	V_{CEO}	20	V
Emitter to base voltage	V_{EBO}	12	V
Peak collector current	I_{CP}	1	A
Collector current	I_C	0.5	A
Collector power dissipation	P_C	600	mW
Junction temperature	T_j	150	°C
Storage temperature	T_{stg}	-55 ~ +150	°C

Electrical Characteristics (Ta=25°C)

Parameter	Symbol	Conditions	min	typ	max	Unit
Collector cutoff current	I_{CBO}	$V_{CB} = 25V, I_E = 0$			100	nA
Collector to base voltage	V_{CBO}	$I_C = 10\mu A, I_E = 0$	25			V
Collector to emitter voltage	V_{CEO}	$I_C = 1mA, I_B = 0$	20			V
Emitter to base voltage	V_{EBO}	$I_E = 10\mu A, I_C = 0$	12			V
Forward current transfer ratio	h_{FE1}^{*1}	$V_{CE} = 2V, I_C = 0.5A^{*2}$	200		800	
	h_{FE2}	$V_{CE} = 2V, I_C = 1A^{*2}$	60			
Collector to emitter saturation voltage	$V_{CE(sat)}$	$I_C = 0.5A, I_B = 20mA$		0.13	0.4	V
Base to emitter saturation voltage	$V_{BE(sat)}$	$I_C = 0.5A, I_B = 50mA$			1.2	V
Transition frequency	f_T	$V_{CB} = 10V, I_E = -50mA, f = 200MHz$		200		MHz
Collector output capacitance	C_{ob}	$V_{CB} = 10V, I_E = 0, f = 1MHz$		10		pF
ON resistance	R_{on}^{*3}			1.0		Ω

*1 h_{FE1} Rank classification

Rank	R	S	T
h_{FE1}	200 ~ 350	300 ~ 500	400 ~ 800

*2 Pulse measurement

*3 R_{on} Measurement circuit

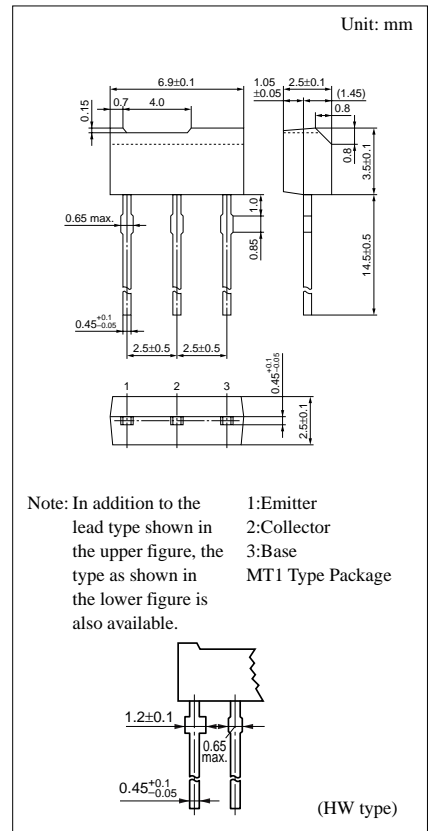
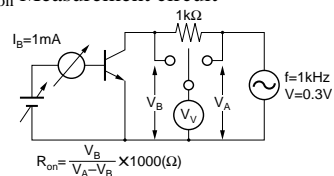

$P_C - T_a$

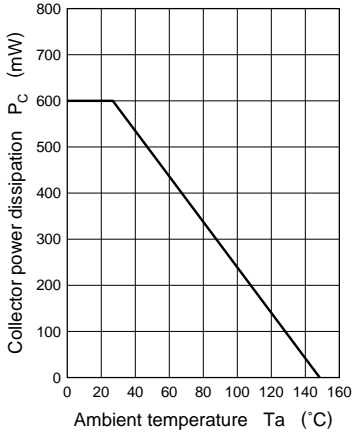

$I_C - V_{CE}$

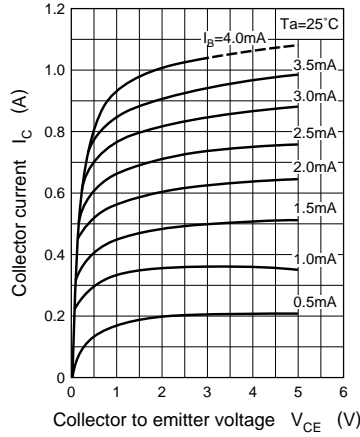

$V_{CE(sat)} - I_C$

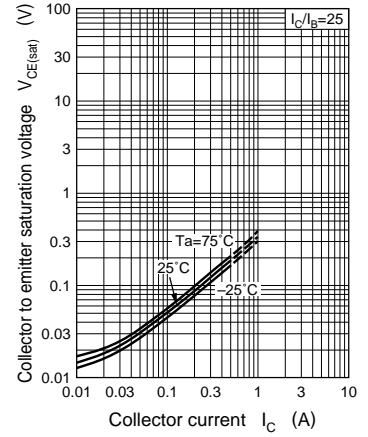

$V_{BE(sat)} - I_C$

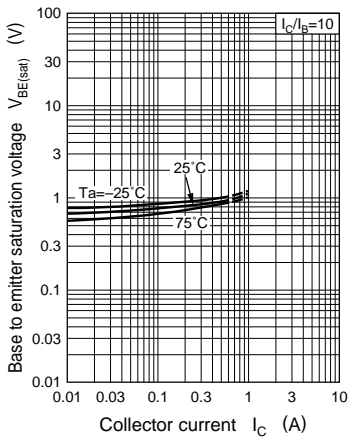

$h_{FE} - I_C$

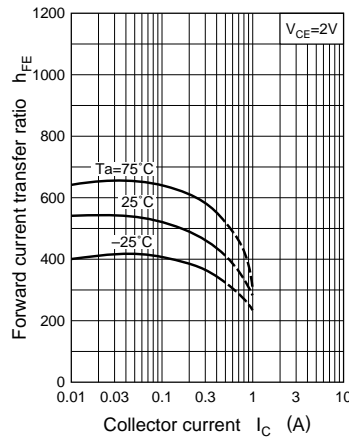

$f_T - I_E$

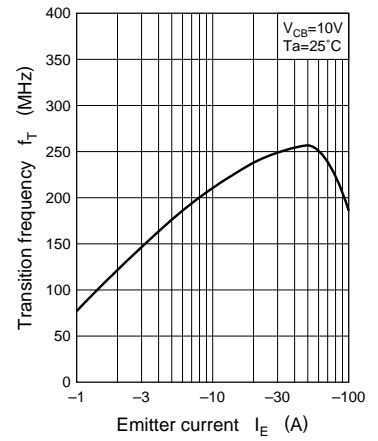

$C_{ob} - V_{CB}$

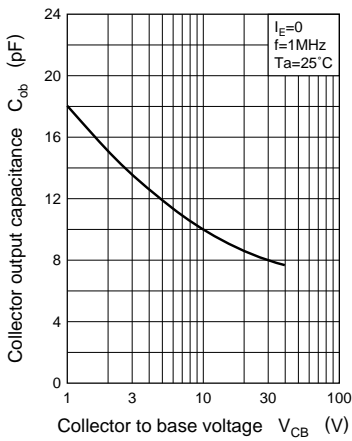

$R_{on} - I_B$

