

No.1752

2SD1654

Silicon NPN Triple Diffused Planar Transistor
COLOR TV HORIZONTAL DEFLECTION OUTPUT APPLICATIONS
(WITH DAMPER DIODE)

Applications

- High-voltage, power switching

Features

- Fast speed ($t_{f,max}=0.7\mu s$).
- High reliability (Adoption of HVP process).
- High breakdown voltage ($V_{CBO}=1500V$).
- Micaless package facilitating mounting operation.

Absolute Maximum Ratings at $T_a=25^\circ C$

Parameter	Symbol	Value	unit
Collector to Base Voltage	V_{CBO}	1500	V
Collector to Emitter Voltage	V_{CEO}	800	V
Emitter to Base Voltage	V_{EBO}	6	V
Collector Current	I_C	3.5	A
Peak Collector Current	i_{cp}	10	A
Collector Dissipation	P_C	50	W
Junction Temperature	T_j	150	$^\circ C$
Storage Temperature	T_{stg}	-55 to +150	$^\circ C$

$T_C=25^\circ C$

Electrical Characteristics at $T_a=25^\circ C$

Parameter	Symbol	Conditions	min	typ	max	unit
Collector Cutoff Current	I_{CBO}	$V_{CB}=800V, I_E=0$			10	μA
Emitter Cutoff Current	I_{EBO}	$V_{EB}=5V, I_C=0$			1	mA
DC Current Gain	h_{FE}	$V_{CE}=5V, I_C=0.5A$	8			
Gain Bandwidth Product	f_T	$V_{CE}=10V, I_C=0.5A$		3		MHz
Collector to Emitter Saturation Voltage	$V_{CE(sat)}$	$I_C=2.5A, I_B=0.8A$			8	V
Base to Emitter Saturation Voltage	$V_{BE(sat)}$	$I_C=2.5A, I_B=0.8A$			1.5	V
Collector to Base Breakdown Voltage	$V_{(BR)CBO}$	$I_C=5mA, I_E=0$	1500			V
Collector to Emitter Breakdown Voltage	$V_{(BR)CEO}$	$I_C=100mA, R_{BE}=\infty$	800			V
Emitter to Base Breakdown Voltage	$V_{(BR)EBO}$	$I_E=200mA, I_C=0$	7			V
Fall Time	t_f	$I_C=3A, I_{B1}=0.8A, I_{B2}=-1.6A$			0.7	μs

Switching Time Test Circuit

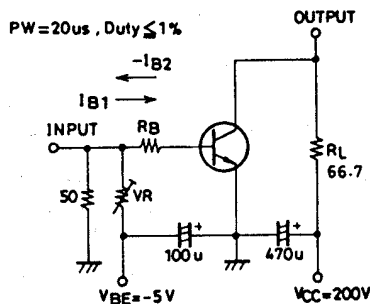

Case Outline 2039 (unit:mm)

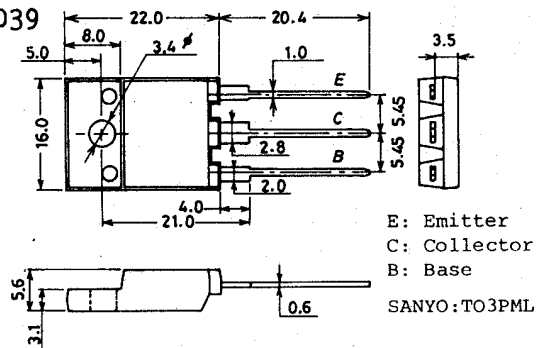

These specifications are subject to change without notice.

TOKYO SANYO ELECTRIC CO., LTD. SEMICONDUCTOR DIVISION
15-13 6-CHOME, SOTOKANDA, CHIYODA-KU, TOKYO 100 JAPAN