

2SD1211

Silicon NPN epitaxial planer type

For low-frequency amplification

Complementary to 2SB987

Features

- High collector to emitter voltage V_{CEO} .
- Optimum for the driver-stage of a low-frequency and 40 to 60W output amplifier.

Absolute Maximum Ratings (Ta=25°C)

Parameter	Symbol	Ratings	Unit
Collector to base voltage	V_{CBO}	120	V
Collector to emitter voltage	V_{CEO}	120	V
Emitter to base voltage	V_{EBO}	5	V
Peak collector current	I_{CP}	1	A
Collector current	I_C	0.5	A
Collector power dissipation	P_C	1	W
Junction temperature	T_j	150	°C
Storage temperature	T_{stg}	-55 ~ +150	°C

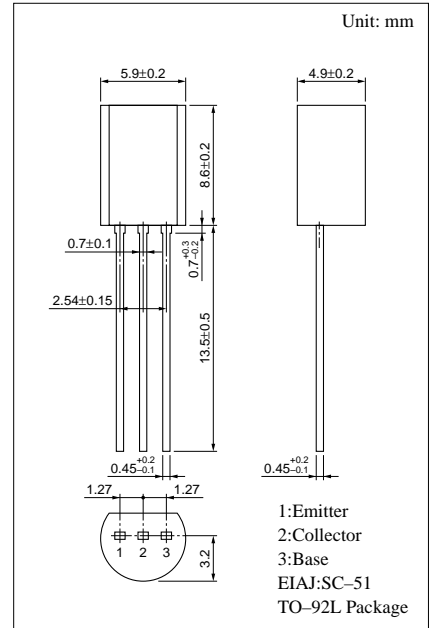

Electrical Characteristics (Ta=25°C)

Parameter	Symbol	Conditions	min	typ	max	Unit
Collector to emitter voltage	V_{CEO}	$I_C = 0.1\text{mA}, I_B = 0$	120			V
Emitter to base voltage	V_{EBO}	$I_E = 10\mu\text{A}, I_C = 0$	5			V
Forward current transfer ratio	h_{FE1}^*	$V_{CE} = 10\text{V}, I_C = 150\text{mA}$	130		330	
	h_{FE2}	$V_{CE} = 5\text{V}, I_C = 500\text{mA}$	50			
Collector to emitter saturation voltage	$V_{CE(sat)}$	$I_C = 300\text{mA}, I_B = 30\text{mA}$			1	V
Base to emitter saturation voltage	$V_{BE(sat)}$	$I_C = 300\text{mA}, I_B = 30\text{mA}$			1.2	V
Transition frequency	f_T	$V_{CB} = 10\text{V}, I_E = -50\text{mA}, f = 200\text{MHz}$		200		MHz
Collector output capacitance	C_{ob}	$V_{CB} = 10\text{V}, I_E = 0, f = 1\text{MHz}$			20	pF

* h_{FE1} Rank classification

Rank	R	S
h_{FE1}	130 ~ 220	185 ~ 330

$P_C - T_a$

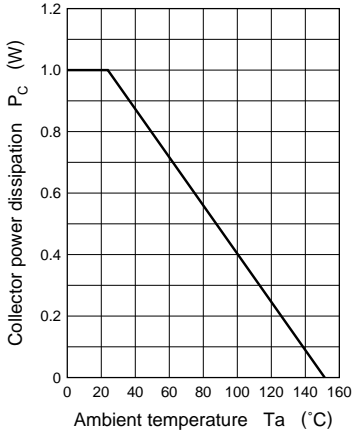

$I_C - V_{CE}$

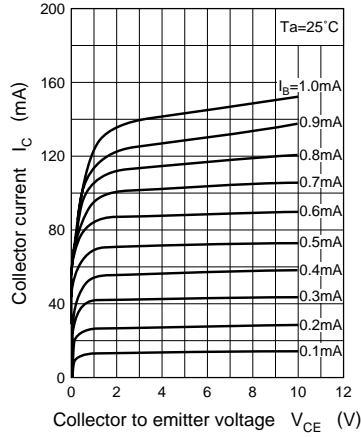

$V_{CE(sat)} - I_C$

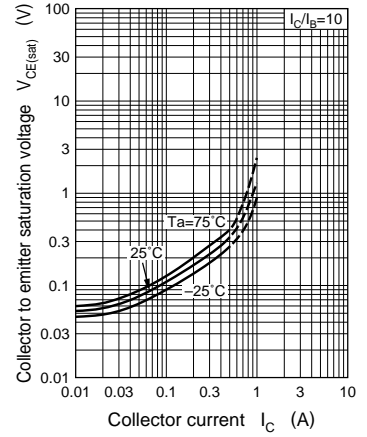

$V_{BE(sat)} - I_C$

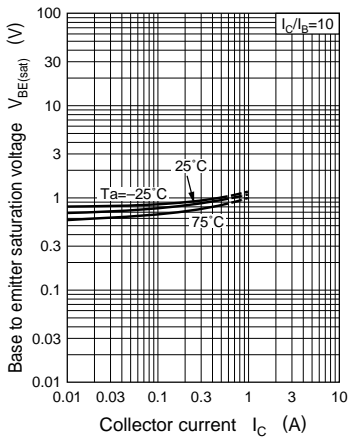

$h_{FE} - I_C$

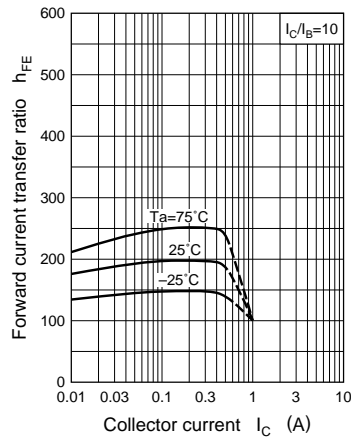

$f_T - I_E$

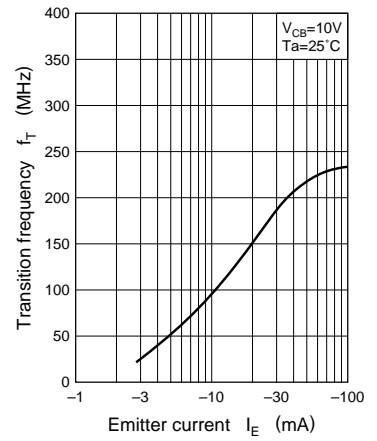

$C_{ob} - V_{CB}$

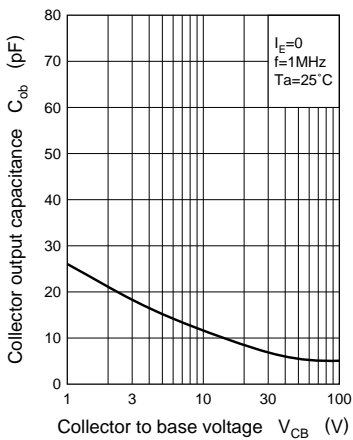

Area of safe operation (ASO)

