

<b>SANYO</b>	No.928C	<b>2SB886/2SD1196</b>
		PNP/NPN Planar Silicon Darlington Transistors

**Driver Applications**

**Applications**

- Motor drivers, printer hammer drivers, relay drivers, voltage regulator control.

**Features**

- High DC current gain.
- High current capacity and wide ASO.
- Low saturation voltage.

( ) : 2SB886

**Absolute Maximum Ratings at Ta = 25°C**

			unit
Collector-to-Base Voltage	V <sub>CB0</sub>	(-)110	V
Collector-to-Emitter Voltage	V <sub>CEO</sub>	(-)100	V
Emitter-to-Base Voltage	V <sub>EBO</sub>	(-)6	V
Collector Current	I <sub>C</sub>	(-)8	A
Collector Current (Pulse)	I <sub>CP</sub>	(-)12	A
Collector Dissipation	P <sub>C</sub>	1.75	W
		40	W
Junction Temperature	T <sub>j</sub>	150	°C
Storage Temperature	T <sub>stg</sub>	-55 to +150	°C

Tc = 25°C

**Electrical Characteristics at Ta = 25°C**

			min	typ	max	unit
Collector Cutoff Current	I <sub>CBO</sub>	V <sub>CB</sub> = (-)80V, I <sub>E</sub> = 0			(-)0.1	mA
Emitter Cutoff Current	I <sub>EBO</sub>	V <sub>EB</sub> = (-)5V, I <sub>C</sub> = 0			(-)3.0	mA
DC Current Gain	h <sub>FE</sub>	V <sub>CE</sub> = (-)3V, I <sub>C</sub> = (-)4A	1500	4000		
Gain Bandwidth Product	f <sub>T</sub>	V <sub>CE</sub> = (-)5V, I <sub>C</sub> = (-)4A		20		MHz
C-E Saturation Voltage	V <sub>CE(sat)</sub>	I <sub>C</sub> = (-)4A, I <sub>B</sub> = (-)8mA		0.9	(-)1.5	V
				(-1.0)		
B-E Saturation Voltage	V <sub>BE(sat)</sub>	I <sub>C</sub> = (-)4A, I <sub>B</sub> = (-)8mA			(-)2.0	V
C-B Breakdown Voltage	V <sub>(BR)CBO</sub>	I <sub>C</sub> = (-)5mA, I <sub>E</sub> = 0	(-)110			V
C-E Breakdown Voltage	V <sub>(BR)CEO</sub>	I <sub>C</sub> = (-)50mA, R <sub>BE</sub> = ∞	(-)100			V
Rise Time	t <sub>on</sub>	See specified Test Circuit.	(0.7)	0.6		μs
Storage Time	t <sub>stg</sub>	"	(1.4)	4.8		μs
Fall Time	t <sub>f</sub>	"	(1.5)	1.6		μs

**Specified Test Circuit**

(For PNP, the polarity is reversed.)

PW = 50μs, Duty Cycle ≤ 1%  
500I<sub>B1</sub> = -500I<sub>B2</sub> = I<sub>C</sub> = 4A

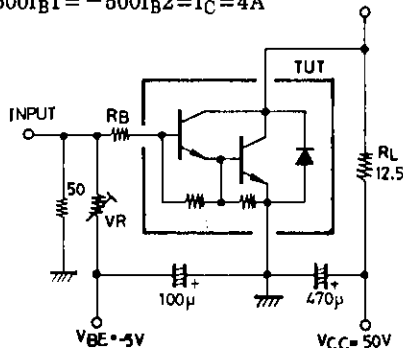

Unit (Resistance : Ω, Capacitance : F)

**Electrical Connection**

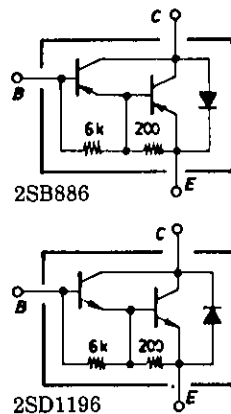

**Package Dimensions 2010C**  
(unit : mm)

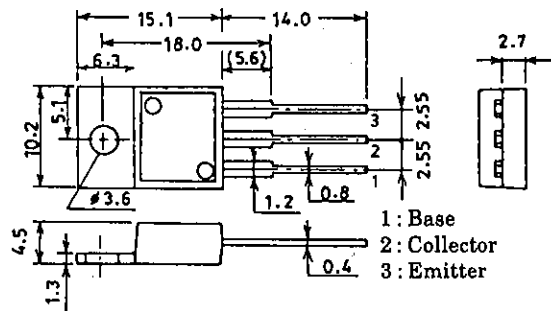

1 : Base  
2 : Collector  
3 : Emitter

JEDEC : TO220AB  
EIAJ : SC46

**SANYO Electric Co., Ltd. Semiconductor Business Headquarters**  
TOKYO OFFICE Tokyo Bldg., 1-10, 1 Chome, Ueno, Taito-ku, TOKYO, 110 JAPAN

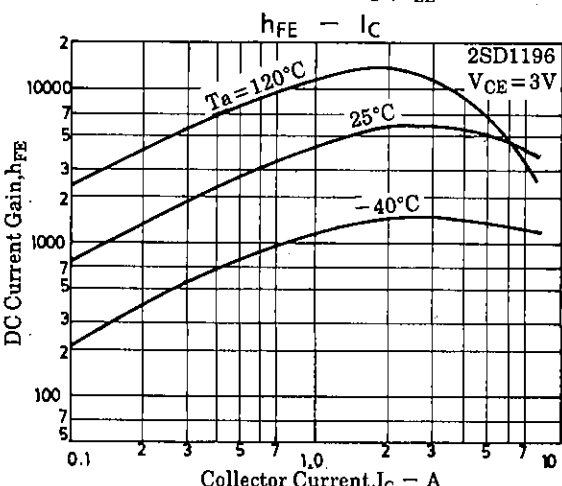
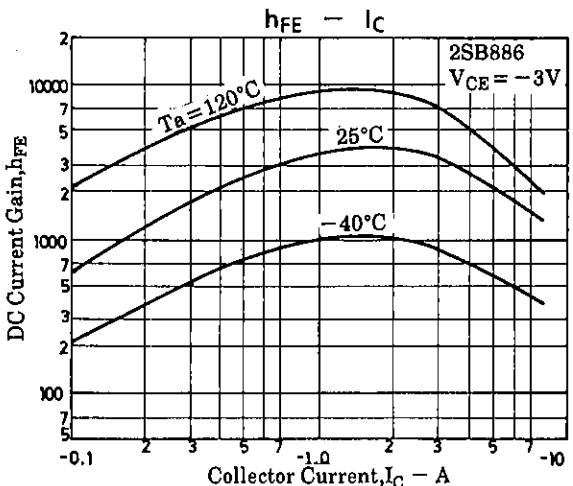
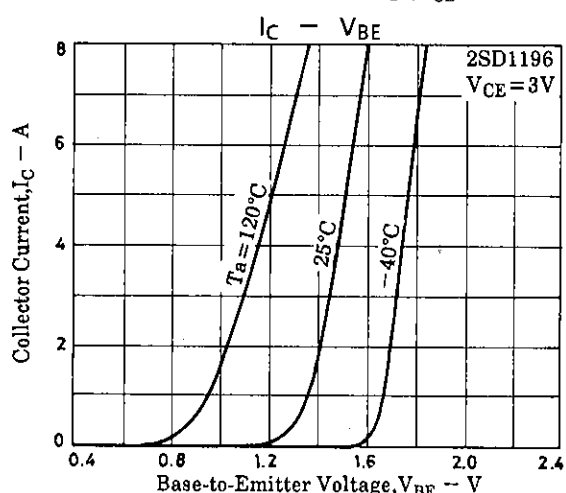
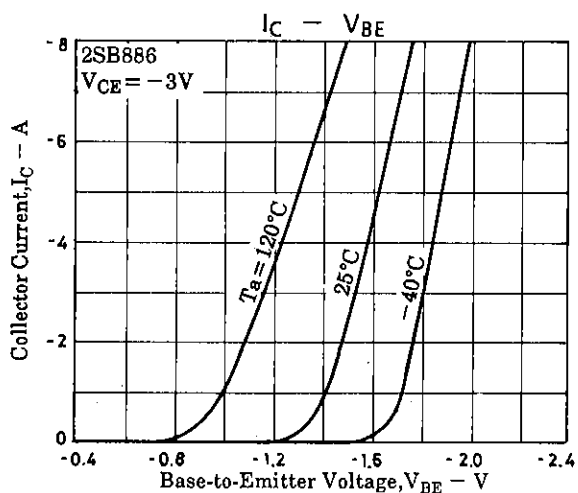
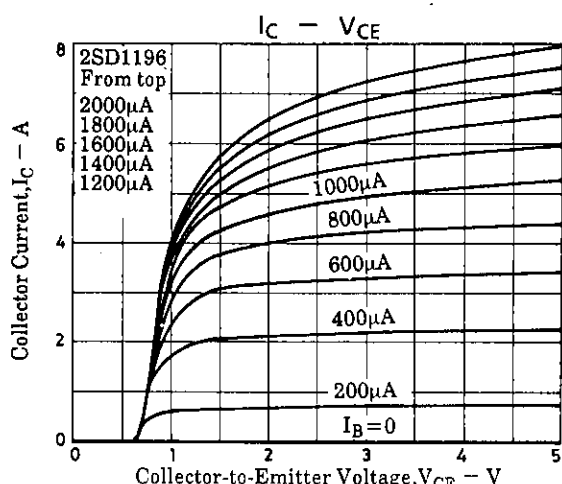
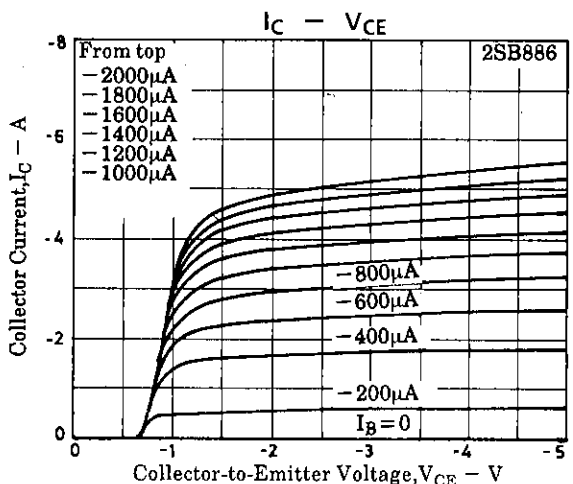
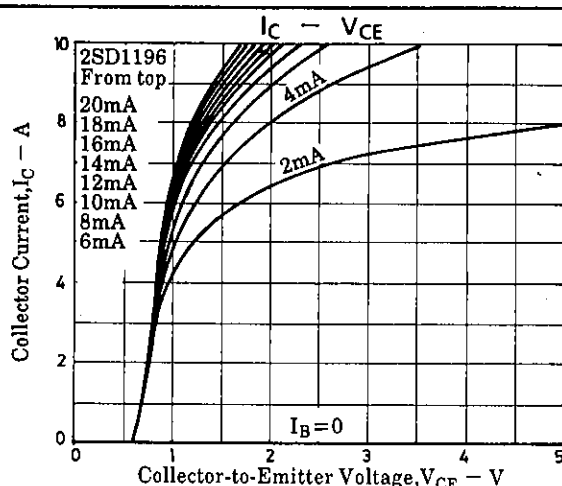
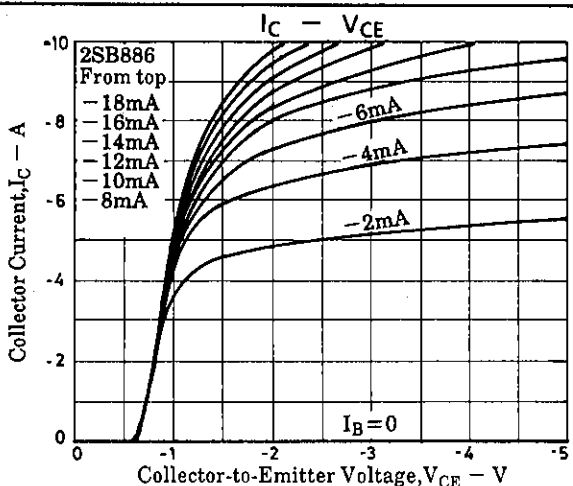

2SB886/2SD1196

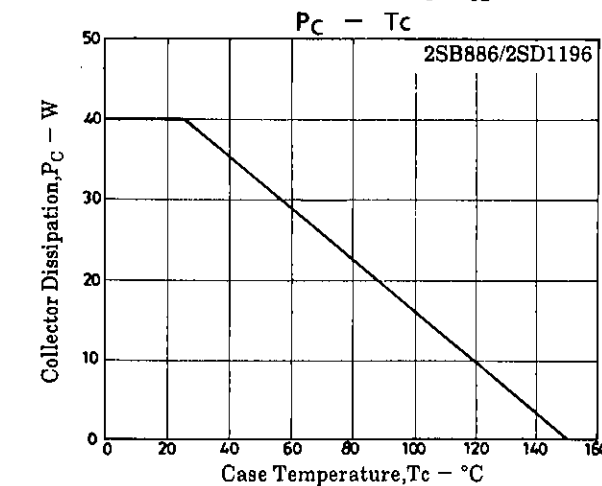
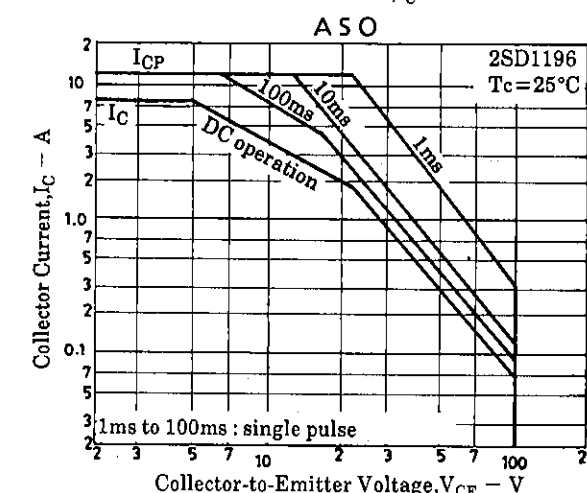
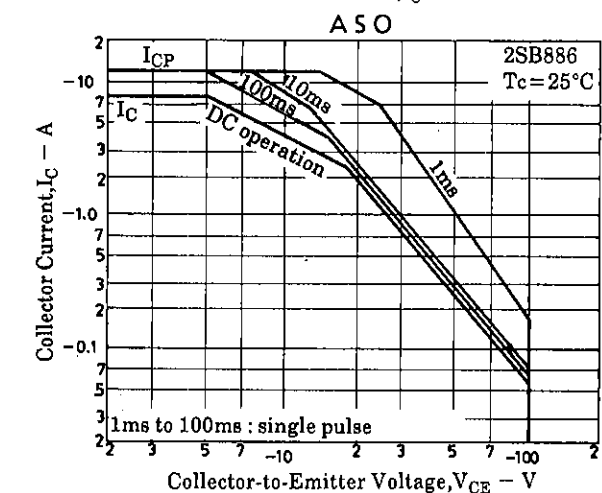
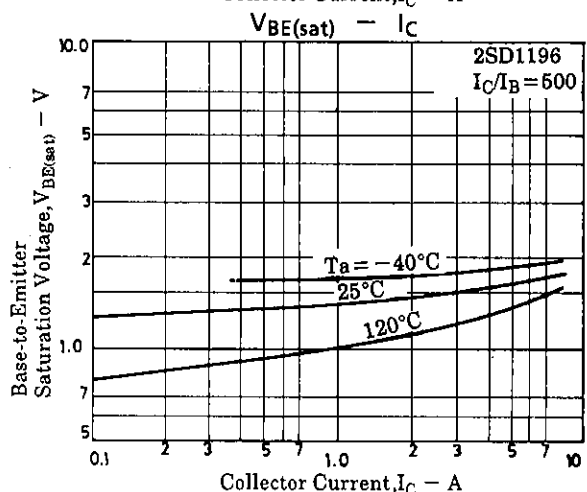
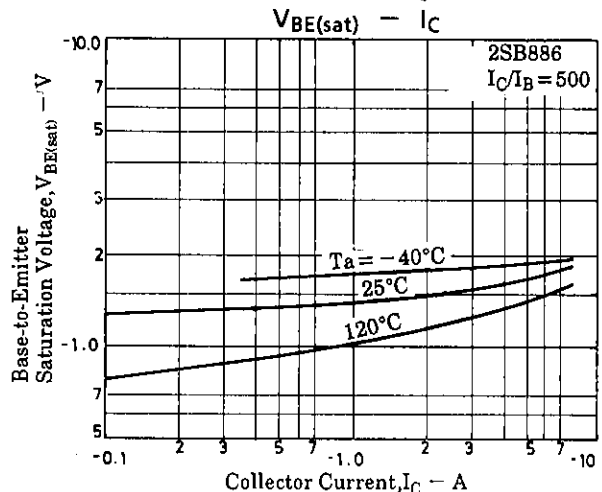
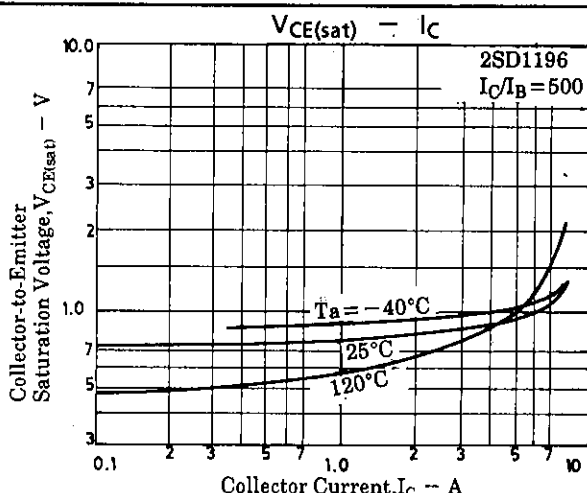
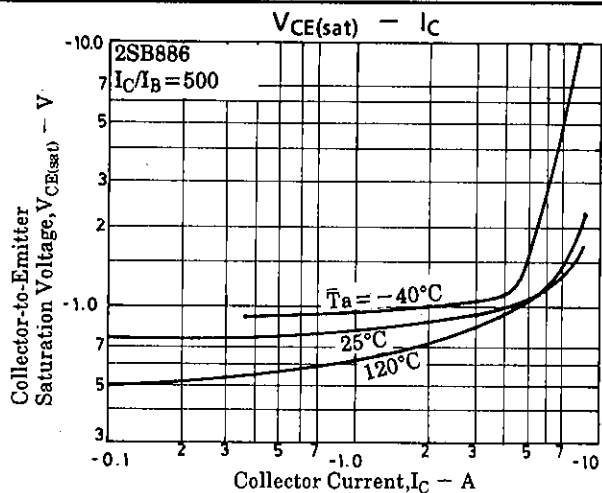

- No products described or contained herein are intended for use in surgical implants, life-support systems, aerospace equipment, nuclear power control systems, vehicles, disaster/crime-prevention equipment and the like, the failure of which may directly or indirectly cause injury, death or property loss.
- Anyone purchasing any products described or contained herein for an above-mentioned use shall:
  - ① Accept full responsibility and indemnify and defend SANYO ELECTRIC CO., LTD., its affiliates, subsidiaries and distributors and all their officers and employees, jointly and severally, against any and all claims and litigation and all damages, cost and expenses associated with such use;
  - ② Not impose any responsibility for any fault or negligence which may be cited in any such claim or litigation on SANYO ELECTRIC CO., LTD., its affiliates, subsidiaries and distributors or any of their officers and employees jointly or severally.
- Information (including circuit diagrams and circuit parameters) herein is for example only; it is not guaranteed for volume production. SANYO believes information herein is accurate and reliable, but no guarantees are made or implied regarding its use or any infringements of intellectual property rights or other rights of third parties.

This catalog provides information as of January, 1996. Specifications and information herein are subject to change without notice.