

2SC5998

Silicon NPN Epitaxial High Frequency Medium Power Amplifier

REJ03G0169-0100Z

Rev.1.00

Apr.20.2004

Features

- High Transition Frequency
 $f_T = 11 \text{ GHz typ.}$
- High gain and Excellent Efficiency
Maximum Available Gain (MAG) = +22 dB typ. at $V_{CE} = 3.6 \text{ V}$, $I_C = 100 \text{ mA}$, $f = 500 \text{ MHz}$
Power Added Efficiency (PAE) = 70% typ. at $P_{in} = +16 \text{ dBm}$, $f = 500 \text{ MHz}$
- High Collector to Emitter Voltage
 $V_{CEO} = 5 \text{ V}$
- Ideal for up to 2GHz applications.
e.g FRS(Family Radio Service) Power Amplifier ,
GMRS (General Mobile Radio Service) Driver Amplifier

Outline

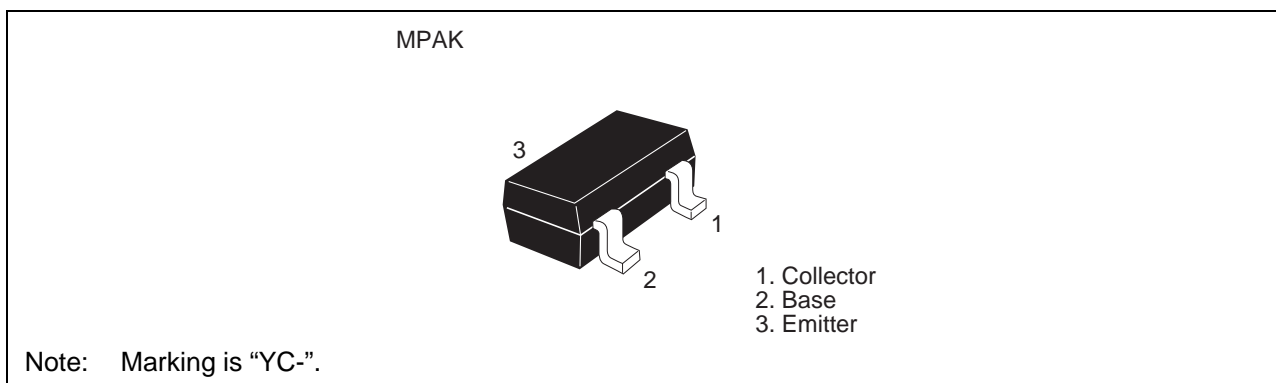

Absolute Maximum Ratings

($T_a = 25^\circ\text{C}$)

Item	Symbol	Ratings	Unit
Collector to base voltage	V_{CBO}	13	V
Collector to emitter voltage	V_{CEO}	5	V
Emitter to base voltage	V_{EBO}	1.5	V
Collector current	I_C	500	mA
Collector power dissipation	P_C	700 ^{note}	mW
Junction temperature	T_J	150	$^\circ\text{C}$
Storage temperature	T_{stg}	-55 to +150	$^\circ\text{C}$

Note: Value on PCB (FR-4 : 25 x 30 x 1.0mm Double side)

Electrical Characteristics

(Ta = 25°C)

Item	Symbol	Min	Typ	Max	Unit	Test Conditions
DC current transfer ratio	h_{FE}	110	150	190	—	$V_{CE} = 3\text{ V}$, $I_C = 100\text{ mA}$
Collector output capacitance	C_{ob}	—	2.0	—	pF	$V_{CB} = 3\text{ V}$, $I_E = 0$, $f = 1\text{ MHz}$
Reverse Transfer Capacitance	C_{re}	—	0.95	1.5	pF	$V_{CB} = 3\text{ V}$, $f = 1\text{ MHz}$, Emitter grounded
Transition Frequency	f_T	—	11	—	GHz	$V_{CE} = 3.6\text{ V}$, $I_C = 100\text{ mA}$, $f = 1\text{ GHz}$
Maximum Available Gain	MAG	—	22	—	dB	$V_{CE} = 3.6\text{ V}$, $I_C = 100\text{ mA}$, $f = 0.5\text{ GHz}$
Power Gain	PG	11	13	—	dB	$V_{CE} = 3.6\text{ V}$, $I_{Cq} = 20\text{ mA}$, $f = 0.5\text{ GHz}$, $P_{in} = +16\text{ dBm}$
1dB Compression Point at output	P1dB	—	28	—	dBm	$V_{CE} = 3.6\text{ V}$, $I_{Cq} = 20\text{ mA}$, $f = 0.5\text{ GHz}$
Added Power Efficiency	PAE	—	70	—	%	$V_{CE} = 3.6\text{ V}$, $I_{Cq} = 20\text{ mA}$, $f = 0.5\text{ GHz}$

Main Characteristics

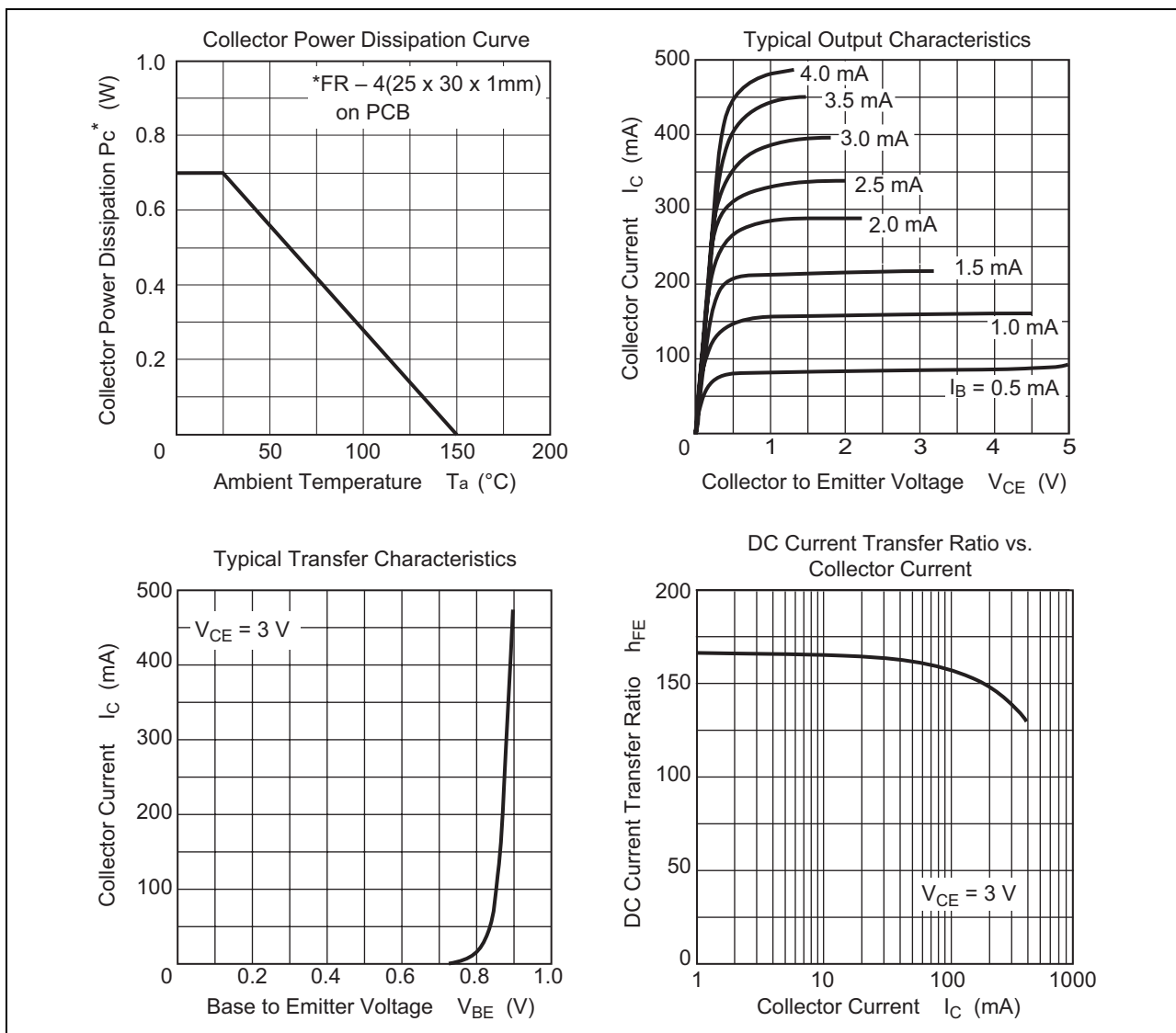

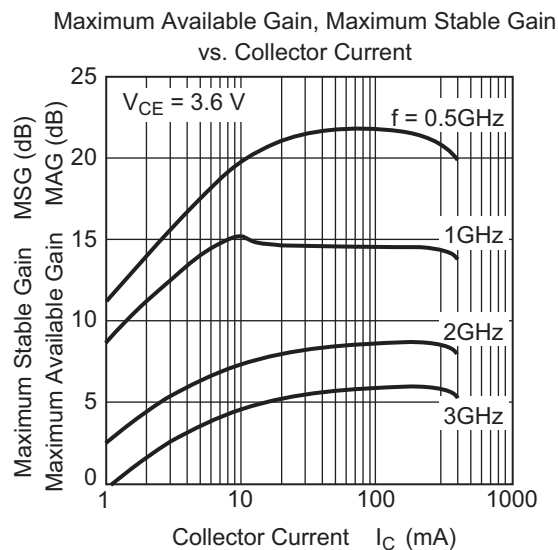
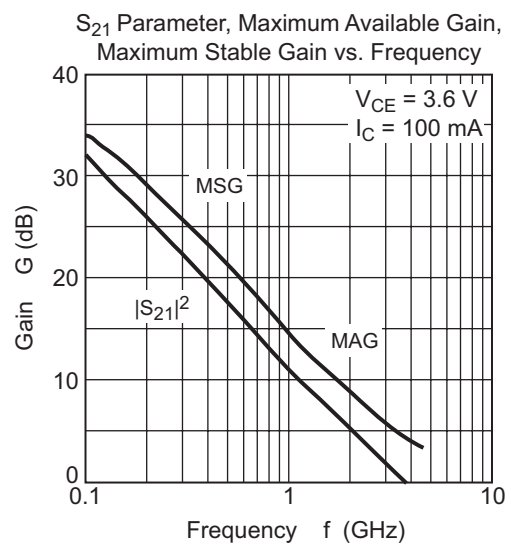
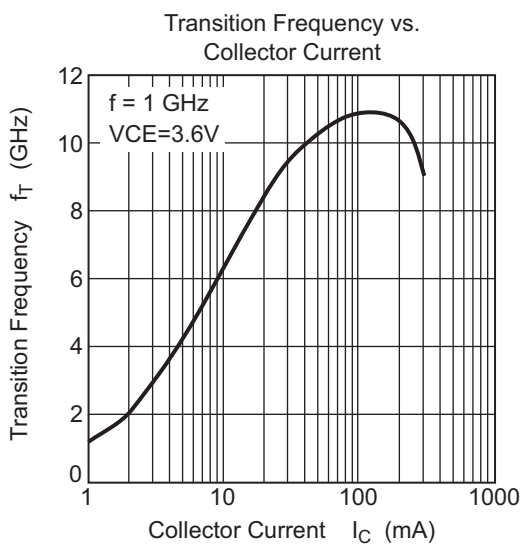
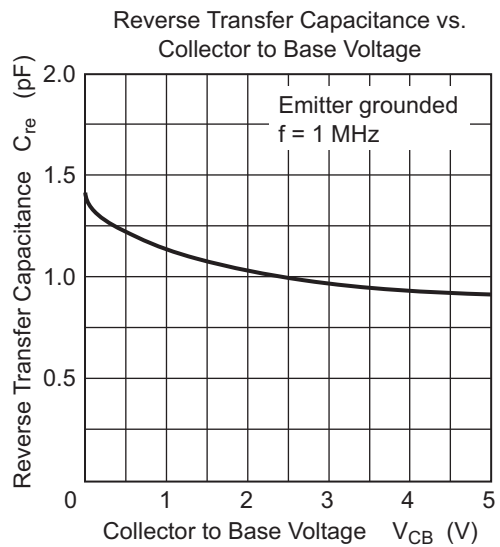
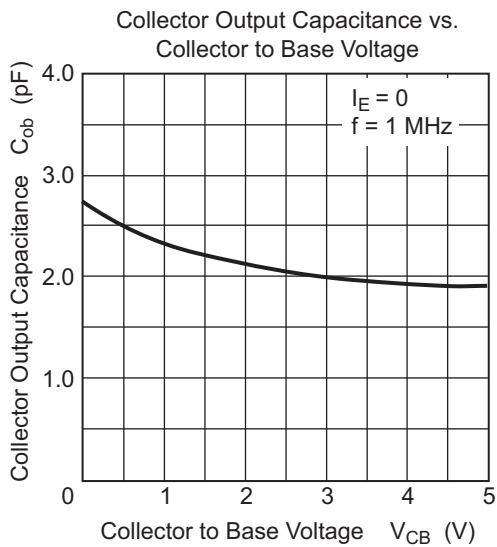

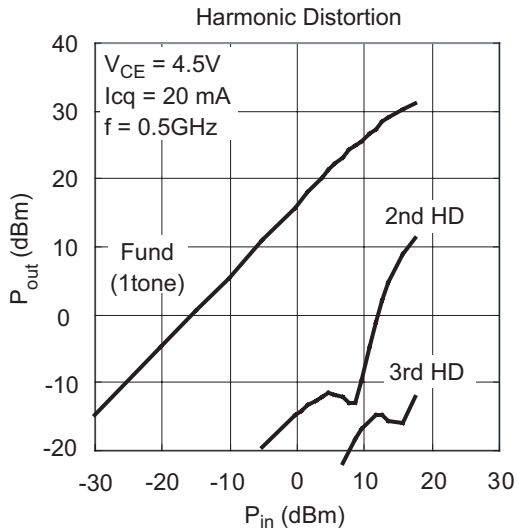
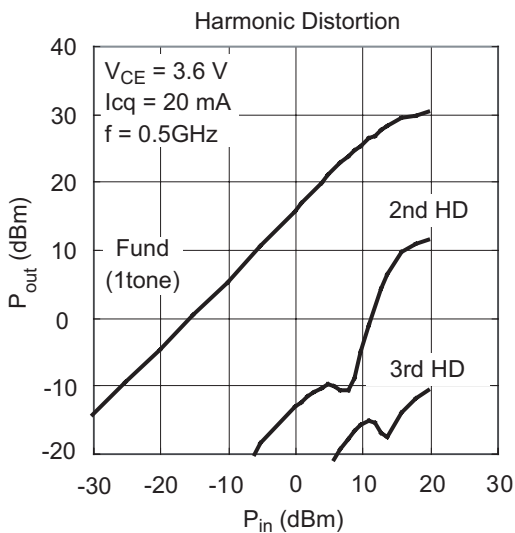
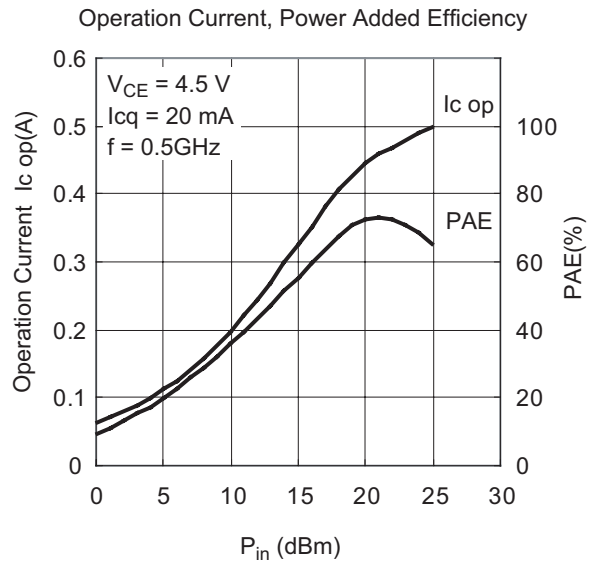
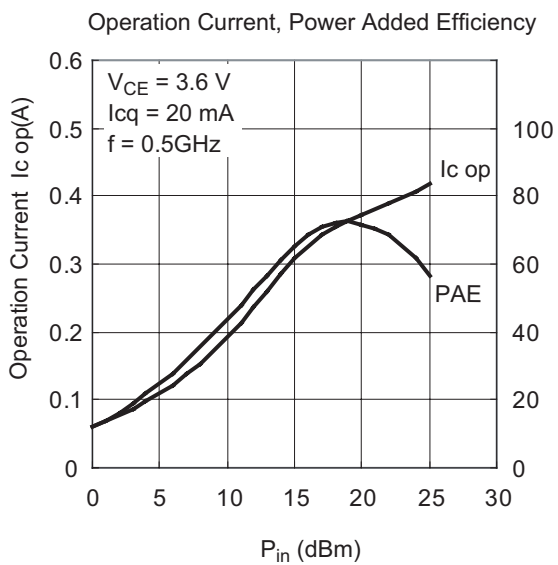
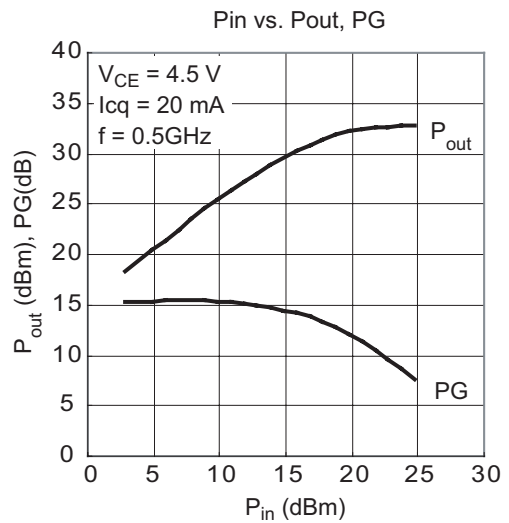
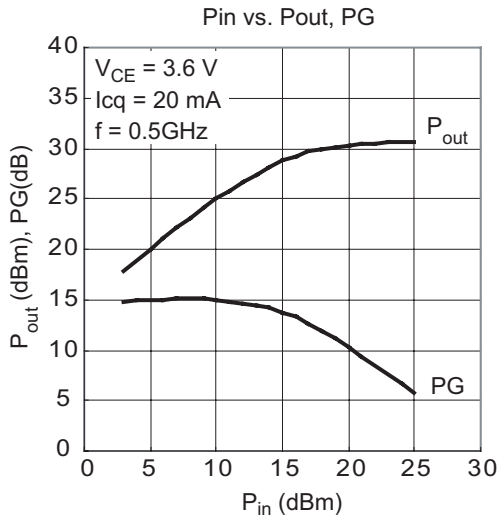

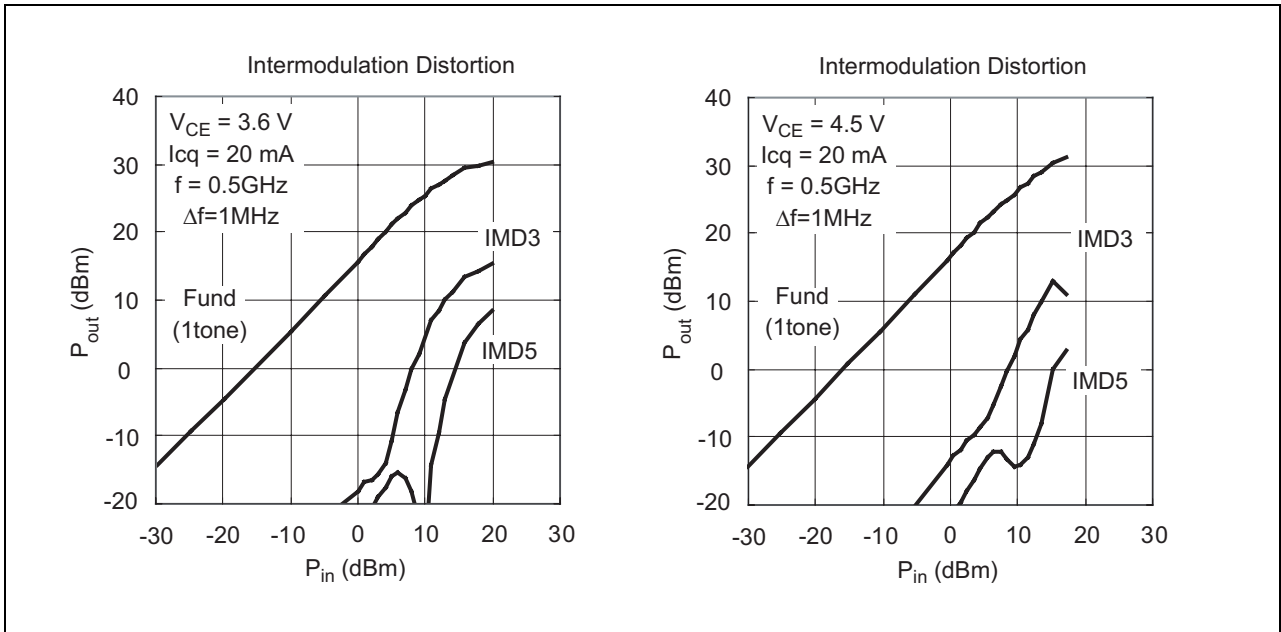

0.5GHz Evaluation Circuit

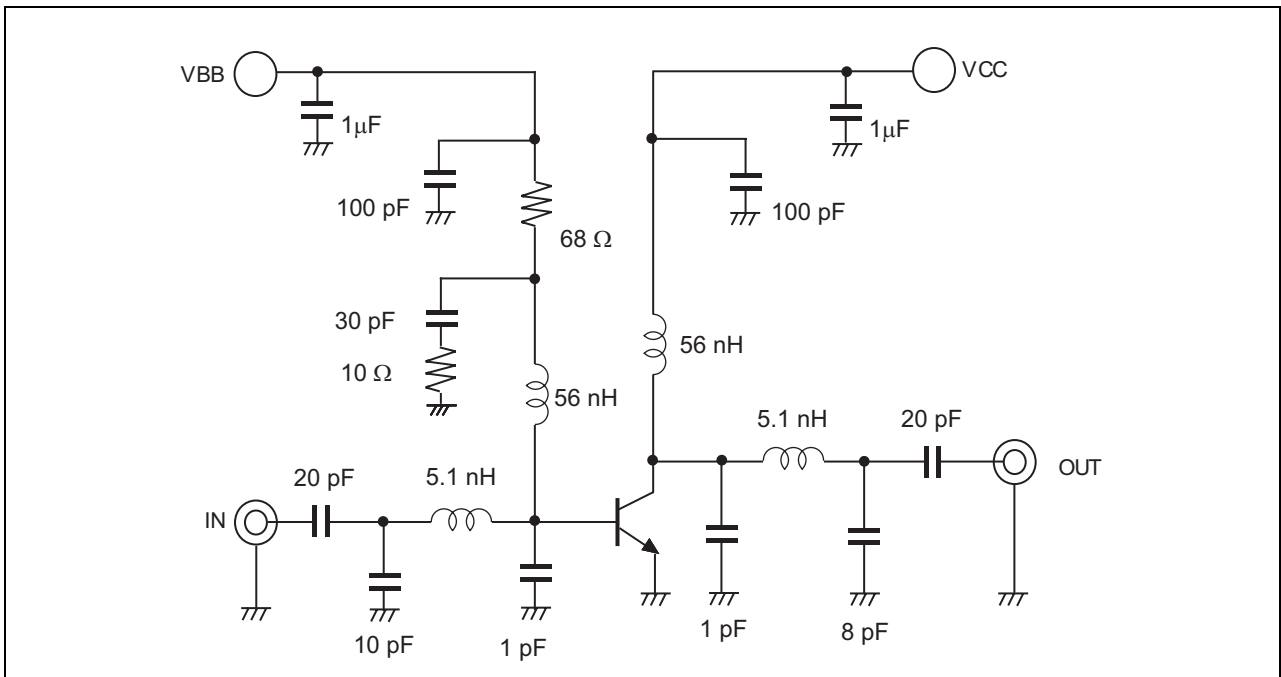

S parameter $(V_{CE} = 3.6 \text{ V}, I_C = 20 \text{ mA}, Z_o = 50 \Omega)$

f (MHz)	S11		S21		S12		S22	
	MAG	ANG	MAG	ANG	MAG	ANG	MAG	ANG
100	0.643	-108.1	31.06	121.7	0.0292	48.9	0.630	-81.4
200	0.635	-143.5	18.05	101.3	0.0371	41.8	0.469	-115.8
300	0.641	-158.8	12.26	91.2	0.0437	45.4	0.423	-134.7
400	0.645	-168.0	9.17	84.4	0.0500	48.0	0.409	-147.1
500	0.651	-174.7	7.24	79.3	0.0560	49.6	0.404	-155.7
600	0.657	-180.0	5.96	75.0	0.0641	51.3	0.407	-162.6
700	0.662	175.5	5.05	71.2	0.0716	52.4	0.410	-168.4
800	0.667	171.4	4.37	67.9	0.0795	52.6	0.415	-173.4
900	0.672	167.7	3.85	64.8	0.0874	53.2	0.420	-177.7
1000	0.677	164.2	3.43	61.9	0.0949	52.3	0.426	178.2
1100	0.682	161.1	3.10	59.1	0.1024	52.0	0.431	174.7
1200	0.686	158.0	2.83	56.4	0.1100	51.0	0.436	171.2
1300	0.690	155.1	2.60	53.7	0.1176	50.3	0.442	168.1
1400	0.696	152.2	2.41	51.2	0.1251	49.2	0.448	165.1
1500	0.701	149.6	2.24	48.6	0.1322	48.1	0.455	162.2
1600	0.706	147.0	2.09	46.1	0.1391	47.2	0.462	159.6
1700	0.711	144.5	1.97	43.8	0.1457	45.9	0.469	157.1
1800	0.716	142.1	1.85	41.4	0.1527	44.7	0.476	154.7
1900	0.721	139.7	1.75	39.0	0.1592	43.4	0.483	152.4
2000	0.725	137.4	1.66	36.7	0.1653	41.9	0.489	150.1
2100	0.731	135.2	1.58	34.5	0.1714	40.6	0.496	148.0
2200	0.736	133.0	1.51	32.2	0.1771	39.4	0.504	145.9
2300	0.741	130.9	1.44	30.0	0.1831	38.0	0.511	144.0
2400	0.745	128.9	1.38	27.8	0.1884	36.5	0.519	141.9
2500	0.750	126.9	1.33	25.7	0.1940	35.1	0.526	140.0
2600	0.756	125.0	1.28	23.6	0.1995	34.0	0.534	138.1
2700	0.760	123.0	1.23	21.5	0.2043	32.5	0.540	136.3
2800	0.764	121.1	1.18	19.5	0.2083	31.2	0.548	134.5
2900	0.768	119.3	1.14	17.5	0.2130	29.7	0.555	132.8
3000	0.773	117.6	1.11	15.6	0.2172	28.2	0.562	131.2

S parameter $(V_{CE} = 3.6 \text{ V}, I_C = 50 \text{ mA}, Z_o = 50 \Omega)$

f (MHz)	S11		S21		S12		S22	
	MAG	ANG	MAG	ANG	MAG	ANG	MAG	ANG
100	0.586	-142.9	38.37	109.9	0.0190	53.1	0.525	-110.1
200	0.616	-163.8	20.35	94.5	0.0276	57.6	0.450	-140.8
300	0.629	-172.9	13.52	86.7	0.0355	61.5	0.441	-154.9
400	0.638	-178.7	10.03	81.3	0.0448	62.6	0.445	-163.4
500	0.645	176.8	7.89	77.1	0.0532	63.9	0.449	-169.9
600	0.650	172.8	6.48	73.6	0.0628	63.6	0.457	-174.8
700	0.656	169.3	5.48	70.4	0.0717	63.0	0.463	-179.2
800	0.661	165.9	4.75	67.5	0.0808	62.2	0.469	176.8
900	0.665	162.8	4.18	64.8	0.0904	61.7	0.475	173.5
1000	0.670	159.8	3.73	62.2	0.0989	59.9	0.481	170.0
1100	0.674	157.0	3.38	59.7	0.1075	58.4	0.487	167.0
1200	0.678	154.2	3.08	57.2	0.1162	56.9	0.492	164.1
1300	0.683	151.7	2.83	54.8	0.1247	55.5	0.498	161.4
1400	0.688	149.1	2.62	52.4	0.1326	53.9	0.504	158.7
1500	0.693	146.6	2.44	50.0	0.1403	52.4	0.510	156.2
1600	0.697	144.2	2.28	47.7	0.1478	50.9	0.516	153.8
1700	0.702	141.9	2.14	45.5	0.1550	49.2	0.523	151.5
1800	0.707	139.6	2.02	43.2	0.1625	47.5	0.529	149.3
1900	0.712	137.4	1.91	41.0	0.1690	46.0	0.535	147.2
2000	0.716	135.2	1.81	38.8	0.1756	44.3	0.541	145.1
2100	0.722	133.1	1.73	36.7	0.1819	42.5	0.548	143.0
2200	0.727	131.1	1.65	34.5	0.1879	41.1	0.555	141.1
2300	0.731	129.1	1.57	32.5	0.1941	39.4	0.561	139.2
2400	0.736	127.1	1.51	30.3	0.1994	37.7	0.567	137.3
2500	0.741	125.2	1.45	28.3	0.2054	36.3	0.574	135.3
2600	0.746	123.4	1.39	26.3	0.2108	34.7	0.580	133.6
2700	0.751	121.5	1.34	24.3	0.2152	33.2	0.586	131.8
2800	0.754	119.7	1.29	22.3	0.2200	31.6	0.593	130.2
2900	0.758	117.9	1.25	20.5	0.2244	30.2	0.600	128.5
3000	0.763	116.3	1.21	18.6	0.2286	28.5	0.606	126.9

S parameter(V_{CE} = 3.6 V, I_C = 100 mA, Z_o = 50 Ω)

f (MHz)	S11		S21		S12		S22	
	MAG	ANG	MAG	ANG	MAG	ANG	MAG	ANG
100	0.587	-158.5	40.54	105.4	0.0155	56.9	0.499	-123.7
200	0.618	-171.9	20.95	91.8	0.0245	66.6	0.459	-150.4
300	0.631	-178.0	13.81	85.0	0.0342	69.1	0.460	-161.9
400	0.640	177.3	10.20	80.2	0.0433	70.4	0.467	-169.2
500	0.647	173.4	8.02	76.5	0.0532	69.5	0.473	-174.7
600	0.652	170.0	6.58	73.3	0.0630	68.0	0.481	-179.2
700	0.657	166.8	5.58	70.4	0.0728	66.8	0.487	177.0
800	0.662	163.7	4.84	67.7	0.0829	65.5	0.493	173.3
900	0.666	160.8	4.27	65.2	0.0924	64.2	0.498	170.3
1000	0.671	158.0	3.81	62.8	0.1009	62.6	0.504	167.1
1100	0.675	155.4	3.45	60.3	0.1097	60.7	0.510	164.3
1200	0.678	152.7	3.15	58.0	0.1187	58.9	0.515	161.5
1300	0.683	150.2	2.90	55.6	0.1273	57.3	0.520	159.0
1400	0.687	147.8	2.69	53.3	0.1354	55.4	0.526	156.5
1500	0.692	145.4	2.50	50.9	0.1434	53.6	0.531	154.0
1600	0.696	143.1	2.34	48.7	0.1513	52.1	0.538	151.7
1700	0.701	140.8	2.20	46.5	0.1586	50.2	0.543	149.5
1800	0.706	138.6	2.08	44.3	0.1658	48.6	0.549	147.4
1900	0.711	136.4	1.97	42.1	0.1733	46.8	0.555	145.3
2000	0.715	134.3	1.87	39.9	0.1799	45.1	0.561	143.3
2100	0.721	132.2	1.78	37.8	0.1860	43.3	0.567	141.3
2200	0.725	130.2	1.69	35.7	0.1917	41.7	0.574	139.4
2300	0.730	128.2	1.62	33.6	0.1981	40.1	0.580	137.5
2400	0.734	126.3	1.55	31.5	0.2038	38.3	0.586	135.6
2500	0.739	124.4	1.49	29.5	0.2099	36.7	0.592	133.8
2600	0.744	122.6	1.43	27.5	0.2151	35.1	0.599	132.0
2700	0.749	120.8	1.38	25.6	0.2198	33.4	0.605	130.3
2800	0.753	119.0	1.33	23.6	0.2242	31.9	0.611	128.7
2900	0.757	117.2	1.28	21.8	0.2290	30.3	0.617	127.0
3000	0.761	115.5	1.24	19.9	0.2326	28.7	0.623	125.4

S parameter(V_{CE} = 3.6 V, I_C = 200 mA, Z_o = 50 Ω)

f (MHz)	S11		S21		S12		S22	
	MAG	ANG	MAG	ANG	MAG	ANG	MAG	ANG
100	0.607	-166.7	39.88	103.2	0.0111	80.5	0.492	-131.3
200	0.631	-176.2	20.31	90.5	0.0231	72.6	0.471	-155.0
300	0.646	178.9	13.30	84.3	0.0332	72.3	0.474	-165.6
400	0.654	175.0	9.81	80.0	0.0443	72.9	0.482	-172.3
500	0.660	171.4	7.72	76.6	0.0536	72.5	0.488	-177.5
600	0.664	168.2	6.35	73.7	0.0633	70.8	0.493	178.3
700	0.668	165.1	5.40	70.9	0.0737	69.1	0.499	174.6
800	0.672	162.2	4.70	68.4	0.0836	67.3	0.504	171.2
900	0.676	159.4	4.15	65.9	0.0934	65.5	0.508	168.2
1000	0.680	156.7	3.72	63.5	0.1022	63.6	0.514	165.2
1100	0.684	154.2	3.37	61.1	0.1111	61.8	0.518	162.5
1200	0.687	151.6	3.09	58.6	0.1201	60.1	0.522	159.9
1300	0.691	149.2	2.84	56.3	0.1292	58.2	0.527	157.5
1400	0.695	146.7	2.64	53.9	0.1372	56.2	0.532	155.1
1500	0.700	144.4	2.46	51.6	0.1452	54.4	0.539	152.8
1600	0.704	142.1	2.30	49.3	0.1529	52.7	0.544	150.5
1700	0.708	139.9	2.17	47.0	0.1599	50.9	0.549	148.3
1800	0.713	137.7	2.05	44.8	0.1679	49.1	0.555	146.2
1900	0.718	135.5	1.94	42.6	0.1748	47.4	0.561	144.2
2000	0.722	133.5	1.84	40.4	0.1815	45.4	0.567	142.3
2100	0.728	131.4	1.75	38.3	0.1880	43.8	0.573	140.3
2200	0.732	129.4	1.67	36.1	0.1941	42.0	0.580	138.4
2300	0.736	127.5	1.60	34.1	0.2001	40.3	0.586	136.6
2400	0.740	125.6	1.53	31.9	0.2059	38.6	0.592	134.7
2500	0.745	123.7	1.47	29.9	0.2117	37.0	0.598	132.9
2600	0.750	121.9	1.42	27.9	0.2166	35.4	0.605	131.2
2700	0.755	120.1	1.36	26.0	0.2217	33.7	0.609	129.4
2800	0.758	118.3	1.32	24.0	0.2262	32.1	0.616	127.8
2900	0.762	116.5	1.27	22.2	0.2314	30.5	0.622	126.1
3000	0.767	114.9	1.23	20.3	0.2348	28.9	0.628	124.5

Package Dimensions

As of January, 2003
Unit: mm

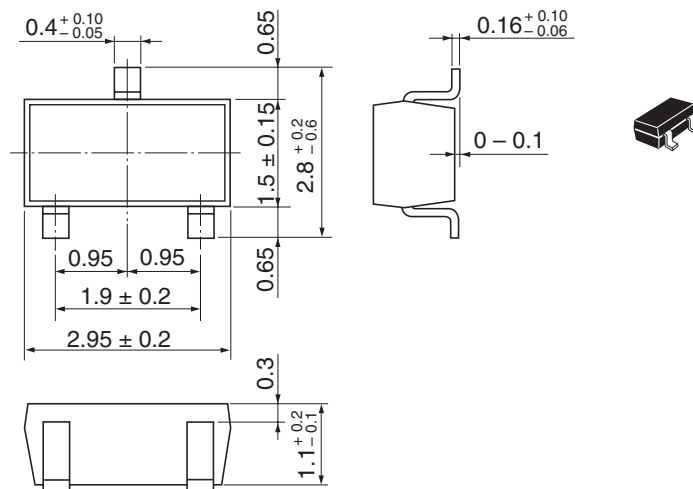

Package Code	MPAK(T)
JEDEC	—
JEITA	Conforms
Mass (reference value)	0.011 g

Ordering Information

Part Name	Quantity	Shipping Container
2SC5998YC	3000	φ178 taping

Note: For some grades, production may be terminated. Please contact the Renesas sales office to check the state of production before ordering the product.

Renesas Technology Corp. Sales Strategic Planning Div. Nippon Bldg., 2-6-2, Ohte-machi, Chiyoda-ku, Tokyo 100-0004, Japan

Keep safety first in your circuit designs!

1. Renesas Technology Corp. puts the maximum effort into making semiconductor products better and more reliable, but there is always the possibility that trouble may occur with them. Trouble with semiconductors may lead to personal injury, fire or property damage. Remember to give due consideration to safety when making your circuit designs, with appropriate measures such as (i) placement of substitutive, auxiliary circuits, (ii) use of nonflammable material or (iii) prevention against any malfunction or mishap.

Notes regarding these materials

1. These materials are intended as a reference to assist our customers in the selection of the Renesas Technology Corp. product best suited to the customer's application; they do not convey any license under any intellectual property rights, or any other rights, belonging to Renesas Technology Corp. or a third party.
 2. Renesas Technology Corp. assumes no responsibility for any damage, or infringement of any third-party's rights, originating in the use of any product data, diagrams, charts, programs, algorithms, or circuit application examples contained in these materials.
 3. All information contained in these materials, including product data, diagrams, charts, programs and algorithms represents information on products at the time of publication of these materials, and are subject to change by Renesas Technology Corp. without notice due to product improvements or other reasons. It is therefore recommended that customers contact Renesas Technology Corp. or an authorized Renesas Technology Corp. product distributor for the latest product information before purchasing a product listed herein.
The information described here may contain technical inaccuracies or typographical errors.
Renesas Technology Corp. assumes no responsibility for any damage, liability, or other loss rising from these inaccuracies or errors.
Please also pay attention to information published by Renesas Technology Corp. by various means, including the Renesas Technology Corp. Semiconductor home page (<http://www.renesas.com>).
 4. When using any or all of the information contained in these materials, including product data, diagrams, charts, programs, and algorithms, please be sure to evaluate all information as a total system before making a final decision on the applicability of the information and products. Renesas Technology Corp. assumes no responsibility for any damage, liability or other loss resulting from the information contained herein.
 5. Renesas Technology Corp. semiconductors are not designed or manufactured for use in a device or system that is used under circumstances in which human life is potentially at stake. Please contact Renesas Technology Corp. or an authorized Renesas Technology Corp. product distributor when considering the use of a product contained herein for any specific purposes, such as apparatus or systems for transportation, vehicular, medical, aerospace, nuclear, or undersea repeater use.
 6. The prior written approval of Renesas Technology Corp. is necessary to reprint or reproduce in whole or in part these materials.
 7. If these products or technologies are subject to the Japanese export control restrictions, they must be exported under a license from the Japanese government and cannot be imported into a country other than the approved destination.
Any diversion or reexport contrary to the export control laws and regulations of Japan and/or the country of destination is prohibited.
 8. Please contact Renesas Technology Corp. for further details on these materials or the products contained therein.
-



RENESAS SALES OFFICES

<http://www.renesas.com>

Renesas Technology America, Inc.

450 Holger Way, San Jose, CA 95134-1368, U.S.A
Tel: <1> (408) 382-7500 Fax: <1> (408) 382-7501

Renesas Technology Europe Limited.

Dukes Meadow, Millboard Road, Bourne End, Buckinghamshire, SL8 5FH, United Kingdom
Tel: <44> (1628) 585 100, Fax: <44> (1628) 585 900

Renesas Technology Europe GmbH

Dornacher Str. 3, D-85622 Feldkirchen, Germany
Tel: <49> (89) 380 70 0, Fax: <49> (89) 929 30 11

Renesas Technology Hong Kong Ltd.

7/F., North Tower, World Finance Centre, Harbour City, Canton Road, Hong Kong
Tel: <852> 2265-6688, Fax: <852> 2375-6836

Renesas Technology Taiwan Co., Ltd.

FL 10, #99, Fu-Hsing N. Rd., Taipei, Taiwan
Tel: <886> (2) 2715-2888, Fax: <886> (2) 2713-2999

Renesas Technology (Shanghai) Co., Ltd.

26/F., Ruijin Building, No.205 Maoming Road (S), Shanghai 200020, China
Tel: <86> (21) 6472-1001, Fax: <86> (21) 6415-2952

Renesas Technology Singapore Pte. Ltd.

1, Harbour Front Avenue, #06-10, Keppel Bay Tower, Singapore 098632
Tel: <65> 6213-0200, Fax: <65> 6278-8001

