

To all our customers

Regarding the change of names mentioned in the document, such as Hitachi Electric and Hitachi XX, to Renesas Technology Corp.

The semiconductor operations of Mitsubishi Electric and Hitachi were transferred to Renesas Technology Corporation on April 1st 2003. These operations include microcomputer, logic, analog and discrete devices, and memory chips other than DRAMs (flash memory, SRAMs etc.) Accordingly, although Hitachi, Hitachi, Ltd., Hitachi Semiconductors, and other Hitachi brand names are mentioned in the document, these names have in fact all been changed to Renesas Technology Corp. Thank you for your understanding. Except for our corporate trademark, logo and corporate statement, no changes whatsoever have been made to the contents of the document, and these changes do not constitute any alteration to the contents of the document itself.

Renesas Technology Home Page: <http://www.renesas.com>

Renesas Technology Corp.
Customer Support Dept.
April 1, 2003

Cautions

Keep safety first in your circuit designs!

1. Renesas Technology Corporation puts the maximum effort into making semiconductor products better and more reliable, but there is always the possibility that trouble may occur with them. Trouble with semiconductors may lead to personal injury, fire or property damage.

Remember to give due consideration to safety when making your circuit designs, with appropriate measures such as (i) placement of substitutive, auxiliary circuits, (ii) use of nonflammable material or (iii) prevention against any malfunction or mishap.

Notes regarding these materials

1. These materials are intended as a reference to assist our customers in the selection of the Renesas Technology Corporation product best suited to the customer's application; they do not convey any license under any intellectual property rights, or any other rights, belonging to Renesas Technology Corporation or a third party.
2. Renesas Technology Corporation assumes no responsibility for any damage, or infringement of any third-party's rights, originating in the use of any product data, diagrams, charts, programs, algorithms, or circuit application examples contained in these materials.
3. All information contained in these materials, including product data, diagrams, charts, programs and algorithms represents information on products at the time of publication of these materials, and are subject to change by Renesas Technology Corporation without notice due to product improvements or other reasons. It is therefore recommended that customers contact Renesas Technology Corporation or an authorized Renesas Technology Corporation product distributor for the latest product information before purchasing a product listed herein.
The information described here may contain technical inaccuracies or typographical errors. Renesas Technology Corporation assumes no responsibility for any damage, liability, or other loss rising from these inaccuracies or errors.
Please also pay attention to information published by Renesas Technology Corporation by various means, including the Renesas Technology Corporation Semiconductor home page (<http://www.renesas.com>).
4. When using any or all of the information contained in these materials, including product data, diagrams, charts, programs, and algorithms, please be sure to evaluate all information as a total system before making a final decision on the applicability of the information and products. Renesas Technology Corporation assumes no responsibility for any damage, liability or other loss resulting from the information contained herein.
5. Renesas Technology Corporation semiconductors are not designed or manufactured for use in a device or system that is used under circumstances in which human life is potentially at stake. Please contact Renesas Technology Corporation or an authorized Renesas Technology Corporation product distributor when considering the use of a product contained herein for any specific purposes, such as apparatus or systems for transportation, vehicular, medical, aerospace, nuclear, or undersea repeater use.
6. The prior written approval of Renesas Technology Corporation is necessary to reprint or reproduce in whole or in part these materials.
7. If these products or technologies are subject to the Japanese export control restrictions, they must be exported under a license from the Japanese government and cannot be imported into a country other than the approved destination.
Any diversion or reexport contrary to the export control laws and regulations of Japan and/or the country of destination is prohibited.
8. Please contact Renesas Technology Corporation for further details on these materials or the products contained therein.

2SC5894

Silicon NPN Epitaxial
High Frequency Low Noise Amplifier / Oscillator

RENESAS

ADE-208-1605A (Z)

Rev.1
Nov. 2002

Features

- High gain bandwidth product
 $f_T = 20$ GHz typ.
- High power gain and low noise figure;
PG = 17.5 dB typ., NF = 1.8 dB typ. at $f = 1.8$ GHz

Outline

CMPAK-4

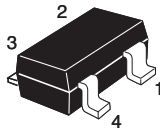

1. Emitter
2. Collector
3. Emitter
4. Base

Note: Marking is "WJ-".

Absolute Maximum Ratings

(Ta = 25 °C)

Item	Symbol	Ratings	Unit
Collector to base voltage	V_{CBO}	12	V
Collector to emitter voltage	V_{CEO}	4.0	V
Emitter to base voltage	V_{EBO}	1.5	V
Collector current	I_C	12	mA
Collector power dissipation	Pc	50	mW
Junction temperature	Tj	150	°C
Storage temperature	Tstg	-55 to +150	°C

Electrical Characteristics

(Ta = 25°C)

Item	Symbol	Min	Typ	Max	Unit	Test conditions
Collector cutoff current	I_{CBO}	—	—	1	μA	$V_{CB} = 12\text{ V}, I_E = 0$
Collector cutoff current	I_{CEO}	—	—	1	μA	$V_{CE} = 4\text{ V}, R_{BE} = \infty$
Emitter cutoff current	I_{EBO}	—	—	10	μA	$V_{EB} = 1.5\text{ V}, I_C = 0$
DC current transfer ratio	h_{FE}	70	110	150	—	$V_{CE} = 2\text{ V}, I_C = 10\text{ mA}$
Collector output capacitance	C_{ob}	—	0.16	0.4	pF	$V_{CB} = 2\text{ V}, I_E = 0, f = 1\text{ MHz}$
Gain bandwidth product	f_T	16	20	—	GHz	$V_{CE} = 2\text{ V}, I_C = 10\text{ mA}$ $f = 2\text{ GHz}$
Power gain	PG	13	17.5	—	dB	$V_{CE} = 2\text{ V}, I_C = 10\text{ mA},$ $f = 1.8\text{ GHz}$
Noise figure	NF	—	1.8	2.4	dB	$V_{CE} = 2\text{ V}, I_C = 3\text{ mA},$ $f = 1.8\text{ GHz}$

Collector Power Dissipation Curve

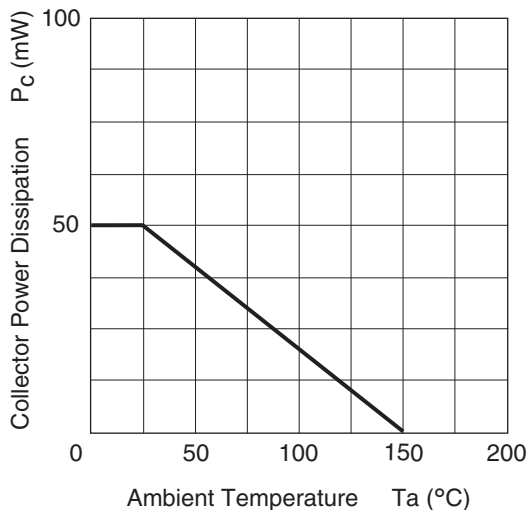

Typical Output Characteristics

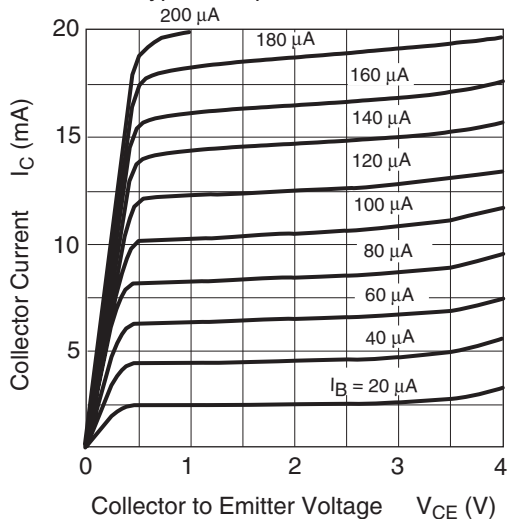

Typical Transfer Characteristics

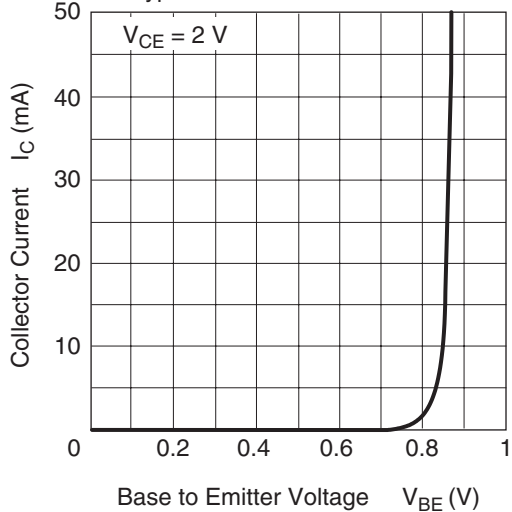

DC Current Transfer Ratio vs. Collector Current

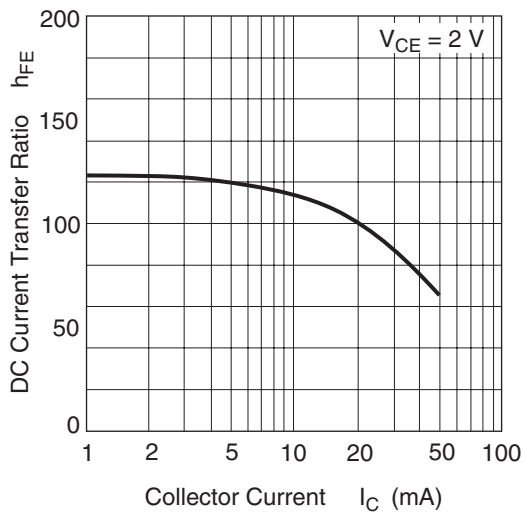

Collector Output Capacitance vs. Collector to Base Voltage

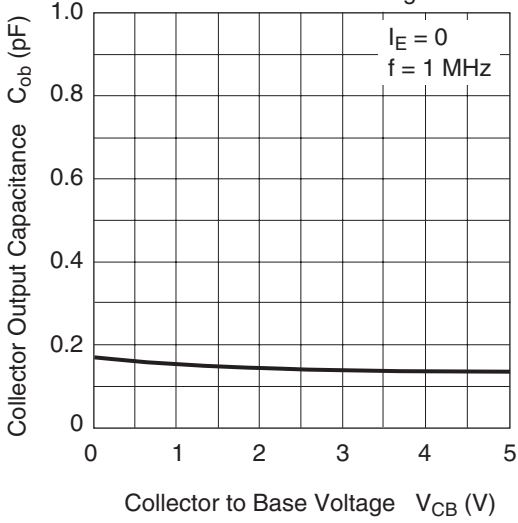

Emitter Input Capacitance vs. Emitter to Base Voltage

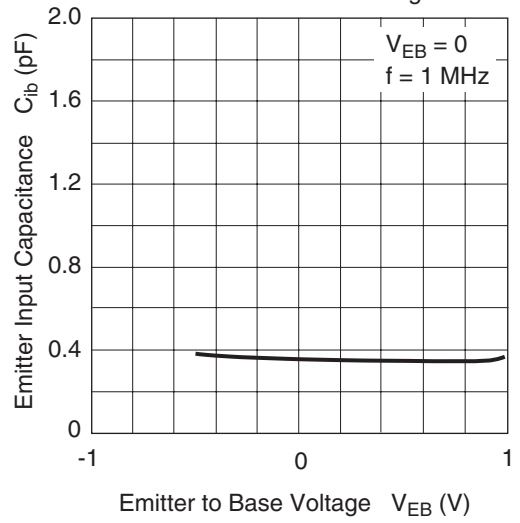

Reverse Transfer Capacitance vs. Collector to Base Voltage

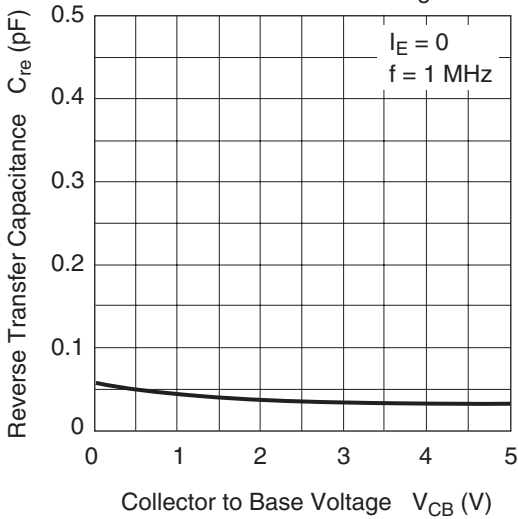

Gain Bandwidth Product vs. Collector Current

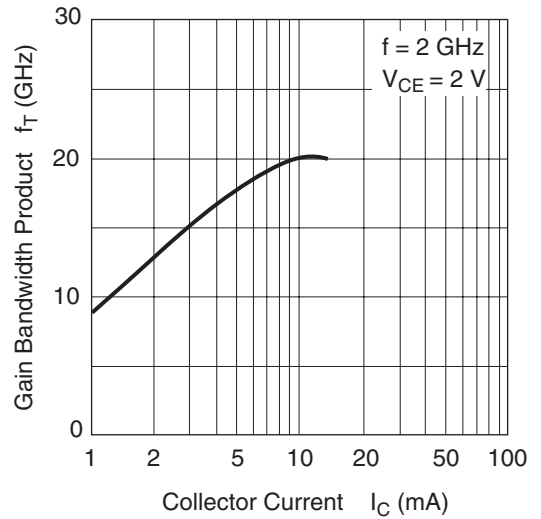

S₂₁ Parameter vs. Collector Current

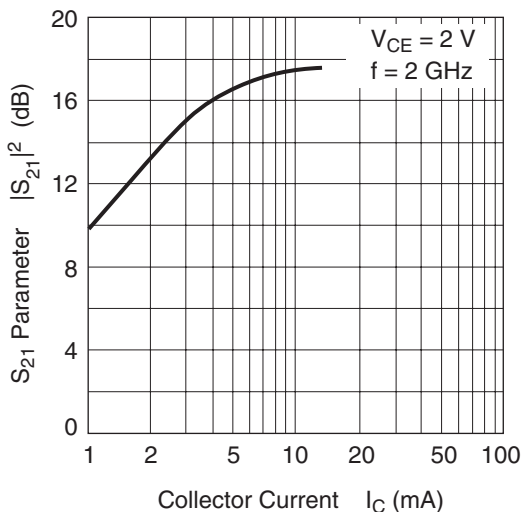

Power Gain vs. Collector Current

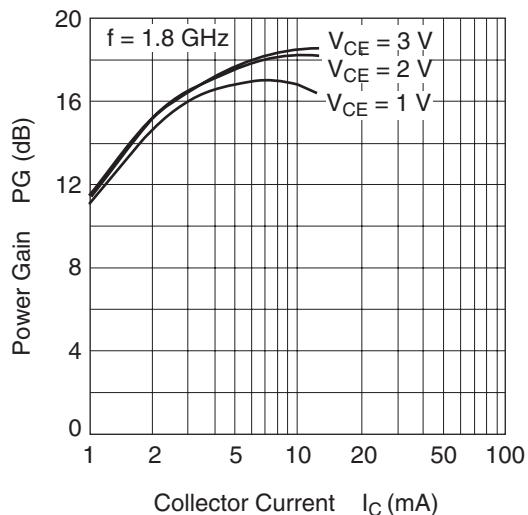

Noise Figure vs. Collector Current

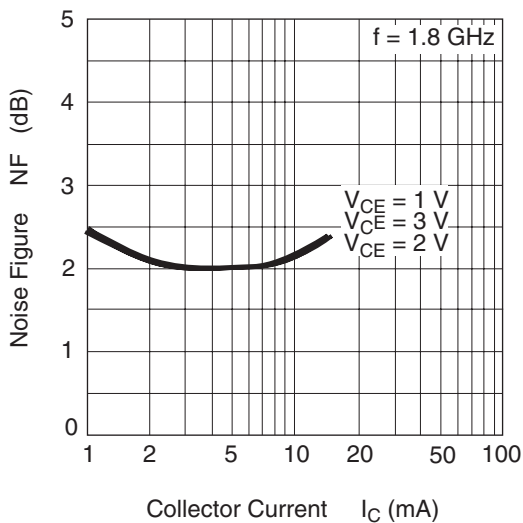

S₁₁ Parameter vs. Frequency

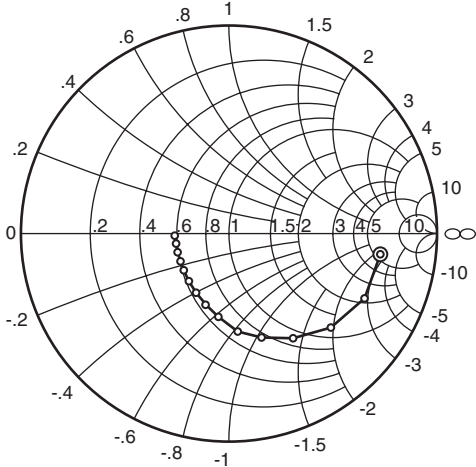

Condition: $V_{CE} = 2\text{ V}$, $Z_O = 50\ \Omega$
 100 to 2900 MHz (200 MHz Step)
 ⊙—○ ($I_C = 10\text{ mA}$)

S₂₁ Parameter vs. Frequency

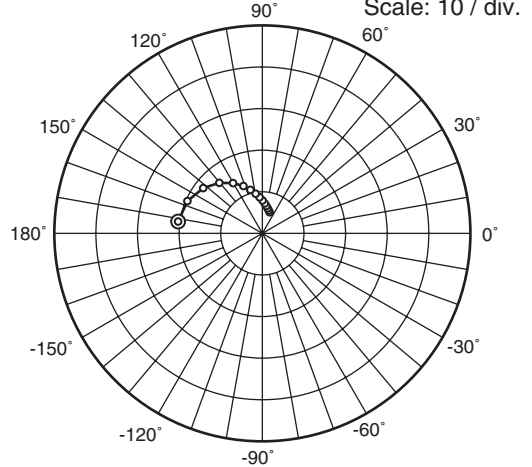

Condition: $V_{CE} = 2\text{ V}$, $Z_O = 50\ \Omega$
 100 to 2900 MHz (200 MHz Step)
 ⊙—○ ($I_C = 10\text{ mA}$)

S₁₂ Parameter vs. Frequency

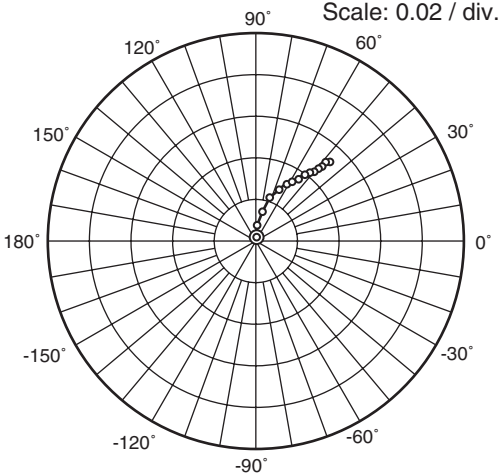

Condition: $V_{CE} = 2\text{ V}$, $Z_O = 50\ \Omega$
 100 to 2900 MHz (200 MHz Step)
 ⊙—○ ($I_C = 10\text{ mA}$)

S₂₂ Parameter vs. Frequency

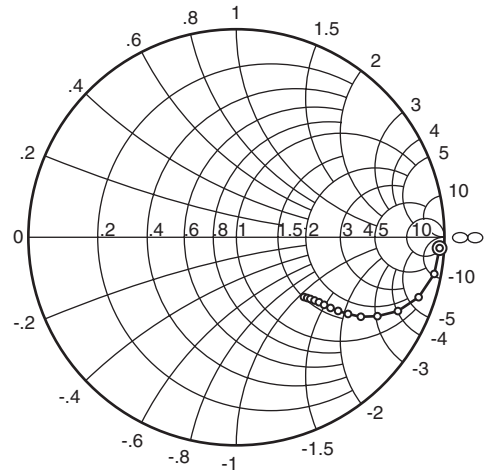

Condition: $V_{CE} = 2\text{ V}$, $Z_O = 50\ \Omega$
 100 to 2900 MHz (200 MHz Step)
 ⊙—○ ($I_C = 10\text{ mA}$)

S Parameter

(V_{CE} = 2 V, I_C = 3 mA, Z_O = 50 Ω)

f (MHz)	S11		S21		S12		S22	
	MAG	ANG	MAG	ANG	MAG	ANG	MAG	ANG
100	0.890	-4.5	9.05	175.5	0.0030	85.7	0.992	-2.0
200	0.892	-9.2	8.88	171.1	0.0064	89.8	0.994	-4.5
300	0.910	-13.9	8.84	166.5	0.0105	91.0	0.991	-6.7
400	0.885	-18.7	8.69	162.1	0.0139	90.5	0.984	-9.4
500	0.876	-23.6	8.57	157.8	0.0185	87.8	0.978	-12.0
600	0.857	-28.5	8.45	153.4	0.0231	84.4	0.966	-14.6
700	0.838	-33.6	8.46	149.2	0.0271	81.0	0.953	-17.2
800	0.825	-38.3	8.13	145.0	0.0316	77.6	0.935	-19.5
900	0.801	-43.0	7.93	141.1	0.0355	73.4	0.914	-21.8
1000	0.776	-47.5	7.56	137.4	0.0392	70.9	0.895	-23.6
1100	0.793	-52.0	7.27	133.2	0.0432	66.5	0.872	-25.9
1200	0.728	-56.8	7.35	129.9	0.0459	63.5	0.849	-28.0
1300	0.700	-61.3	7.15	126.4	0.0487	60.5	0.827	-29.9
1400	0.674	-65.6	6.94	123.1	0.0510	57.0	0.804	-31.4
1500	0.649	-69.7	6.73	120.0	0.0531	54.5	0.783	-33.0
1600	0.624	-74.0	6.54	117.0	0.0555	52.5	0.763	-34.6
1700	0.598	-78.1	6.34	113.9	0.0576	50.7	0.741	-35.9
1800	0.567	-82.7	6.22	111.0	0.0581	48.6	0.719	-37.3
1900	0.554	-86.7	6.00	107.8	0.0610	45.8	0.699	-38.4
2000	0.526	-89.8	5.81	106.2	0.0613	44.9	0.685	-39.6
2100	0.501	-95.3	5.67	102.5	0.0624	42.4	0.660	-40.5
2200	0.487	-97.3	5.33	101.4	0.0642	40.6	0.657	-41.3
2300	0.471	-102.5	5.32	98.0	0.0646	39.5	0.629	-42.4
2400	0.455	-106.5	5.17	95.6	0.0658	38.0	0.615	-43.4
2500	0.434	-111.3	5.08	93.1	0.0663	36.1	0.596	-44.4
2600	0.424	-114.1	4.87	91.5	0.0666	35.2	0.590	-45.2
2700	0.405	-119.3	4.79	88.7	0.0665	35.1	0.572	-46.0
2800	0.396	-121.9	4.63	87.6	0.0677	33.4	0.567	-47.1
2900	0.385	-127.7	4.56	84.3	0.0685	32.2	0.547	-47.5
3000	0.374	-132.6	4.49	81.6	0.0677	31.1	0.530	-48.1

2SC5894

($V_{CE} = 2\text{ V}$, $I_C = 5\text{ mA}$, $Z_o = 50\ \Omega$)

f (MHz)	S11		S21		S12		S22	
	MAG	ANG	MAG	ANG	MAG	ANG	MAG	ANG
100	0.831	-5.8	13.33	174.2	0.0032	85.5	0.988	-2.4
200	0.835	-11.9	13.12	168.6	0.0065	90.4	0.989	-5.4
300	0.844	-18.0	13.04	162.9	0.0101	89.2	0.985	-8.2
400	0.821	-24.2	12.70	157.4	0.0133	88.6	0.974	-11.4
500	0.804	-30.4	12.41	152.0	0.0174	84.4	0.962	-14.5
600	0.779	-36.7	12.07	146.7	0.0216	81.4	0.944	-17.6
700	0.747	-42.7	11.79	141.8	0.0253	77.7	0.921	-20.5
800	0.727	-48.7	11.27	136.8	0.0291	73.9	0.894	-23.1
900	0.695	-54.4	10.82	132.4	0.0319	69.5	0.865	-25.5
1000	0.666	-59.9	10.26	128.0	0.0350	67.6	0.838	-27.4
1100	0.661	-64.8	9.78	123.8	0.0383	62.8	0.808	-29.6
1200	0.601	-70.4	9.57	120.3	0.0399	60.6	0.778	-31.5
1300	0.570	-75.5	9.16	116.7	0.0421	57.8	0.753	-33.1
1400	0.542	-80.3	8.78	113.4	0.0439	55.3	0.726	-34.4
1500	0.516	-85.0	8.40	110.3	0.0454	53.3	0.702	-35.7
1600	0.491	-89.6	8.06	107.4	0.0476	52.5	0.680	-36.8
1700	0.466	-94.2	7.74	104.5	0.0489	50.1	0.658	-37.8
1800	0.440	-99.2	7.48	101.7	0.0492	49.1	0.636	-38.7
1900	0.423	-103.7	7.17	98.9	0.0509	46.8	0.616	-39.5
2000	0.403	-107.6	6.88	97.2	0.0521	46.0	0.603	-40.4
2100	0.383	-113.4	6.65	93.9	0.0522	43.8	0.580	-40.8
2200	0.373	-116.2	6.30	92.6	0.0539	42.9	0.575	-41.5
2300	0.358	-121.5	6.18	89.8	0.0543	42.5	0.553	-42.2
2400	0.347	-125.9	5.97	87.7	0.0554	40.9	0.540	-42.8
2500	0.333	-131.2	5.81	85.5	0.0557	40.7	0.524	-43.5
2600	0.326	-134.6	5.57	83.9	0.0558	40.4	0.519	-44.0
2700	0.314	-140.2	5.43	81.5	0.0579	39.8	0.505	-44.6
2800	0.311	-143.3	5.24	80.3	0.0586	38.4	0.500	-45.4
2900	0.304	-149.0	5.12	77.6	0.0593	38.0	0.484	-45.6
3000	0.301	-153.8	5.00	75.4	0.0585	37.0	0.471	-46.1

($V_{CE} = 2 \text{ V}$, $I_C = 10 \text{ mA}$, $Z_o = 50 \Omega$)

f (MHz)	S11		S21		S12		S22	
	MAG	ANG	MAG	ANG	MAG	ANG	MAG	ANG
100	0.730	-8.4	20.44	172.0	0.0032	93.3	0.978	-3.0
200	0.728	-17.0	20.06	164.3	0.0060	87.1	0.977	-6.8
300	0.722	-25.5	19.61	156.7	0.0090	88.5	0.967	-10.4
400	0.694	-34.2	18.78	149.4	0.0123	86.4	0.946	-14.4
500	0.666	-42.6	17.90	142.5	0.0158	79.7	0.922	-18.2
600	0.630	-50.8	16.93	136.0	0.0191	77.0	0.888	-21.6
700	0.590	-58.5	15.94	130.4	0.0219	73.3	0.853	-24.5
800	0.559	-65.8	14.95	124.9	0.0250	70.9	0.815	-27.0
900	0.523	-72.5	13.98	120.2	0.0271	66.4	0.776	-29.2
1000	0.491	-79.2	13.06	115.8	0.0294	65.3	0.742	-30.7
1100	0.472	-84.8	12.25	111.8	0.0310	62.0	0.709	-32.5
1200	0.430	-91.4	11.57	108.4	0.0331	60.2	0.678	-33.5
1300	0.403	-97.2	10.90	105.2	0.0337	58.6	0.651	-34.5
1400	0.381	-102.9	10.29	102.2	0.0359	56.6	0.627	-35.2
1500	0.360	-108.2	9.73	99.4	0.0365	55.4	0.604	-35.9
1600	0.342	-113.7	9.22	96.8	0.0386	55.2	0.585	-36.5
1700	0.325	-119.0	8.77	94.3	0.0400	53.6	0.566	-36.9
1800	0.309	-124.8	8.36	91.9	0.0404	53.5	0.549	-37.3
1900	0.299	-130.0	7.97	89.6	0.0423	51.8	0.533	-37.6
2000	0.289	-134.9	7.61	87.8	0.0437	52.4	0.522	-38.0
2100	0.279	-140.9	7.28	85.3	0.0439	50.0	0.505	-38.2
2200	0.274	-144.7	6.95	83.7	0.0451	50.0	0.498	-38.6
2300	0.268	-150.1	6.72	81.7	0.0464	49.2	0.484	-39.0
2400	0.264	-154.8	6.46	79.8	0.0478	48.9	0.475	-39.5
2500	0.262	-160.0	6.23	77.9	0.0483	48.5	0.464	-39.8
2600	0.260	-163.9	6.00	76.4	0.0494	47.9	0.458	-40.2
2700	0.258	-169.2	5.80	74.5	0.0510	48.6	0.449	-40.6
2800	0.259	-172.6	5.60	73.1	0.0516	47.4	0.445	-41.1
2900	0.261	-177.2	5.43	71.1	0.0525	47.0	0.434	-41.5
3000	0.263	178.8	5.27	69.3	0.0533	46.4	0.427	-41.8

Package Dimensions

As of July, 2002
Unit: mm

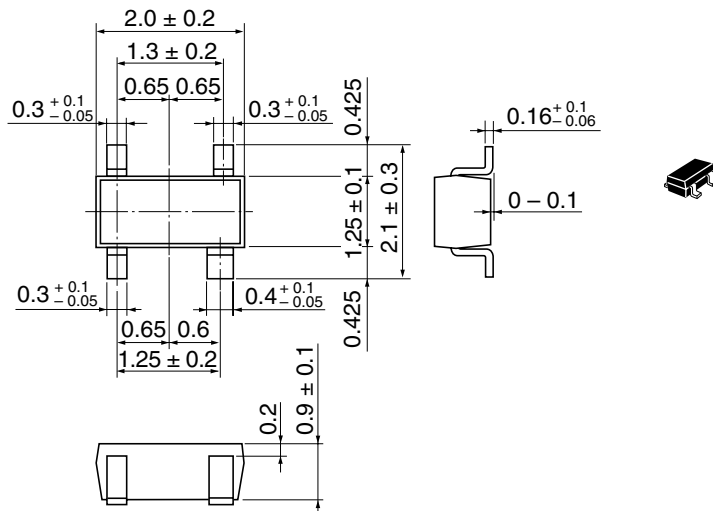

Hitachi Code	CMPAK-4(T)
JEDEC	—
JEITA	Conforms
Mass (reference value)	0.006 g

Disclaimer

1. Hitachi neither warrants nor grants licenses of any rights of Hitachi's or any third party's patent, copyright, trademark, or other intellectual property rights for information contained in this document. Hitachi bears no responsibility for problems that may arise with third party's rights, including intellectual property rights, in connection with use of the information contained in this document.
2. Products and product specifications may be subject to change without notice. Confirm that you have received the latest product standards or specifications before final design, purchase or use.
3. Hitachi makes every attempt to ensure that its products are of high quality and reliability. However, contact Hitachi's sales office before using the product in an application that demands especially high quality and reliability or where its failure or malfunction may directly threaten human life or cause risk of bodily injury, such as aerospace, aeronautics, nuclear power, combustion control, transportation, traffic, safety equipment or medical equipment for life support.
4. Design your application so that the product is used within the ranges guaranteed by Hitachi particularly for maximum rating, operating supply voltage range, heat radiation characteristics, installation conditions and other characteristics. Hitachi bears no responsibility for failure or damage when used beyond the guaranteed ranges. Even within the guaranteed ranges, consider normally foreseeable failure rates or failure modes in semiconductor devices and employ systemic measures such as fail-safes, so that the equipment incorporating Hitachi product does not cause bodily injury, fire or other consequential damage due to operation of the Hitachi product.
5. This product is not designed to be radiation resistant.
6. No one is permitted to reproduce or duplicate, in any form, the whole or part of this document without written approval from Hitachi.
7. Contact Hitachi's sales office for any questions regarding this document or Hitachi semiconductor products.

Sales Offices

HITACHI

Hitachi, Ltd.

Semiconductor & Integrated Circuits
Nippon Bldg., 2-6-2, Ohte-machi, Chiyoda-ku, Tokyo 100-0004, Japan
Tel: <03> 3270-2111 Fax: <03> 3270-5109

URL <http://www.hitachisemiconductor.com/>

For further information write to:

Hitachi Semiconductor
(America) Inc.
179 East Tasman Drive
San Jose, CA 95134
Tel: <1> (408) 433-1990
Fax: <1> (408) 433-0223

Hitachi Europe Ltd.
Electronic Components Group
Whitebrook Park
Lower Cookham Road
Maidenhead
Berkshire SL6 8YA, United Kingdom
Tel: <44> (1628) 585000
Fax: <44> (1628) 778322

Hitachi Europe GmbH
Electronic Components Group
Dornacher Str 3
D-85622 Feldkirchen
Postfach 201, D-85619 Feldkirchen
Germany
Tel: <49> (89) 9 9180-0
Fax: <49> (89) 9 29 30 00

Hitachi Asia Ltd.
Hitachi Tower
16 Collyer Quay #20-00
Singapore 049318
Tel: <65>-6538-6533/6538-8577
Fax: <65>-6538-6933/6538-3877
URL: <http://semiconductor.hitachi.com.sg>

Hitachi Asia Ltd.
(Taipei Branch Office)
4/F, No. 167, Tun Hwa North Road
Hung-Kuo Building
Taipei (105), Taiwan
Tel: <886>-(2)-2718-3666
Fax: <886>-(2)-2718-8180
Telex: 23222 HAS-TP
URL: <http://semiconductor.hitachi.com.tw>

Hitachi Asia (Hong Kong) Ltd.
Group III (Electronic Components)
7/F., North Tower
World Finance Centre,
Harbour City, Canton Road
Tsim Sha Tsui, Kowloon Hong Kong
Tel: <852>-2735-9218
Fax: <852>-2730-0281
URL: <http://semiconductor.hitachi.com.hk>

Copyright © Hitachi, Ltd., 2002. All rights reserved. Printed in Japan.

Colophon 7.0