

2SC5418

Silicon NPN triple diffusion mesa type

For horizontal deflection output

Features

- High breakdown voltage, and high reliability through the use of a glass passivation layer
- High-speed switching
- Wide area of safe operation (ASO)

Absolute Maximum Ratings ($T_C=25^\circ\text{C}$)

Parameter	Symbol	Rated	Unit	
Collector to base voltage	V_{CBO}	1700	V	
Collector to emitter voltage	V_{CES}	1700	V	
	V_{CEO}	600	V	
Emitter to base voltage	V_{EBO}	5	V	
Peak collector current	I_{CP}	30	A	
Collector current	I_C	20	A	
Base current	I_B	10	A	
Collector power dissipation	P_C	$T_C=25^\circ\text{C}$	100	W
		$T_a=25^\circ\text{C}$	3.5	
Junction temperature	T_j	150	$^\circ\text{C}$	
Storage temperature	T_{stg}	-55 to +150	$^\circ\text{C}$	

Electrical Characteristics ($T_C=25^\circ\text{C}$)

Parameter	Symbol	Conditions	min	typ	max	Unit
Collector cutoff current	I_{CBO}	$V_{CB} = 1000\text{V}, I_E = 0$			50	μA
		$V_{CB} = 1700\text{V}, I_E = 0$			1	mA
Emitter cutoff current	I_{EBO}	$V_{EB} = 5\text{V}, I_C = 0$			50	μA
Forward current transfer ratio	h_{FE}	$V_{CE} = 5\text{V}, I_C = 10\text{A}$	7		14	
Collector to emitter saturation voltage	$V_{CE(sat)}$	$I_C = 10\text{A}, I_B = 2.8\text{A}$			3	V
Base to emitter saturation voltage	$V_{BE(sat)}$	$I_C = 10\text{A}, I_B = 2.8\text{A}$			1.5	V
Transition frequency	f_T	$V_{CE} = 10\text{V}, I_C = 0.1\text{A}, f = 0.5\text{MHz}$		3		MHz
Storage time	t_{stg}	$I_C = 12\text{A}, I_{B1} = 2.4\text{A}, I_{B2} = -4.8\text{A}$			4.0	μs
Fall time	t_f				0.3	μs

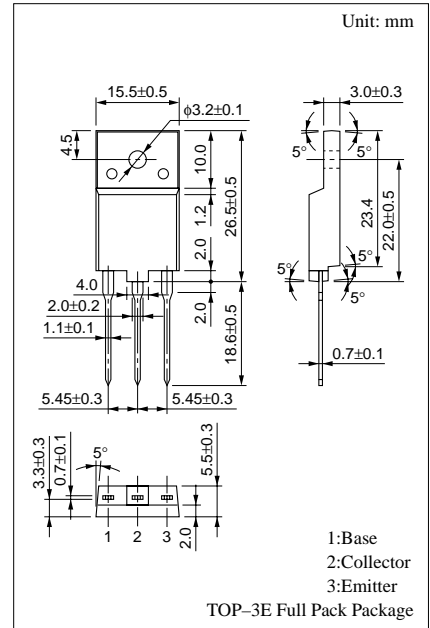

$P_C - T_a$

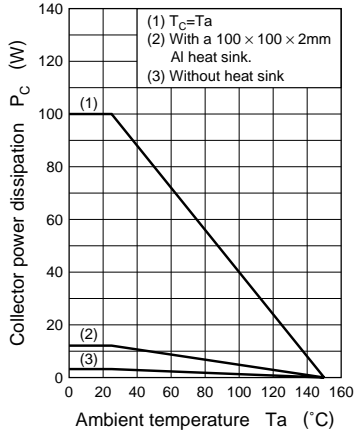

Area of safe operation (ASO)

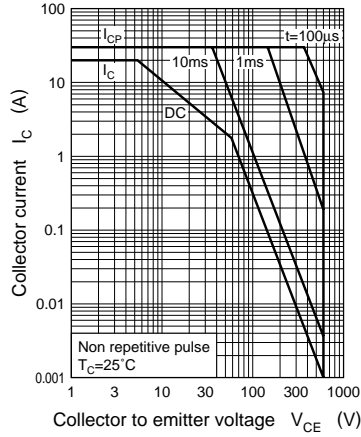

Area of safe operation, horizontal operation ASO

