

NPN EPITAXIAL SILICON TRANSISTOR IN SUPER MINI-MOLD PACKAGE
FOR LOW-NOISE MICROWAVE AMPLIFICATION

FEATURES

- Low current consumption and high gain
 $|S_{21e}|^2 = 12 \text{ dB TYP. @ } V_{CE} = 2 \text{ V, } I_c = 7 \text{ mA, } f = 2 \text{ GHz}$
 $|S_{21e}|^2 = 11 \text{ dB TYP. @ } V_{CE} = 1 \text{ V, } I_c = 5 \text{ mA, } f = 2 \text{ GHz}$
- Supper Mini-Mold package

ORDERING INFORMATION

PART NUMBER	QUANTITY	ARRANGEMENT
2SC5180-T1	3 000 units/reel	Embossed tape, 8 mm wide, pins No. 3 (base) and No. 4 (emitter) facing the perforations
2SC5180-T2		Embossed tape, 8 mm wide, pins No. 1 (collector) and No. 2 (emitter) facing the perforations

* Contact your NEC sales representatives to order samples for evaluation (available in batches of 50).

ABSOLUTE MAXIMUM RATINGS (T_A = 25 °C)

Collector to Base Voltage	V _{CBO}	5	V
Collector to Emitter Voltage	V _{CEO}	3	V
Emitter to Base Voltage	V _{EBO}	2	V
Collector Current	I _c	10	mA
Total Power Dissipation	P _T	30	mW
Junction Temperature	T _j	150	°C
Storage Temperature	T _{stg}	-65 to +150	°C

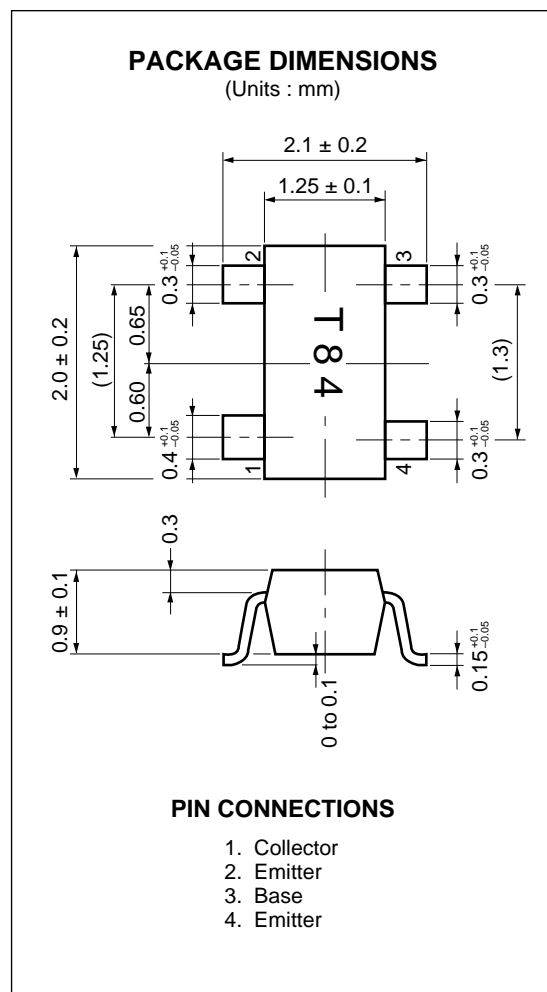

Caution; This transistor uses high-frequency technology. Be careful not to allow excessive current to flow through the transistor, including static electricity.

ELECTRICAL CHARACTERISTICS (T_A = 25 °C)

PARAMETER	SYMBOL	MIN.	TYP.	MAX.	UNIT	CONDITIONS
Collector Cutoff Current	I _{cBO}			100	nA	V _{CB} = 5 V, I _E = 0
Emitter Cutoff Current	I _{EBO}			100	nA	V _{EB} = 1 V, I _c = 0
DC Current Gain	h _{FE}	70		140		V _{CE} = 2 V, I _c = 7 mA* ¹
Insertion Power Gain (1)	S _{21e} ²	10	12		dB	V _{CE} = 2 V, I _c = 7 mA, f = 2 GHz
Insertion Power Gain (2)	S _{21e} ²	8.5	11		dB	V _{CE} = 1 V, I _c = 5 mA, f = 2 GHz
Noise Figure (1)	NF		1.5	2.0	dB	V _{CE} = 2 V, I _c = 3 mA, f = 2 GHz
Noise Figure (2)	NF		1.5	2.0	dB	V _{CE} = 1 V, I _c = 3 mA, f = 2 GHz
Gain Bandwidth Product (1)	f _T	12	15.5		GHz	V _{CE} = 2 V, I _c = 7 mA, f = 2 GHz
Gain Bandwidth Product (2)	f _T	10	13		GHz	V _{CE} = 1 V, I _c = 5 mA, f = 2 GHz
Feedback Capacitance	C _{re}		0.3	0.5	pF	V _{CB} = 2 V, I _E = 0 mA, f = 1 MHz* ²

* 1 : Measured with pulses : Pulse width ≤ 350 μs, duty cycle ≤ 2 %, pulsed

* 2 : Measured with a three-terminal bridge. The emitter and case terminal are connected to the guard terminal of the bridge.

h_{FE} class

Class	FB
Marking	T84
h _{FE}	70 to 140

CHARACTERISTICS CURVES ($T_A = 25\text{ }^\circ\text{C}$)

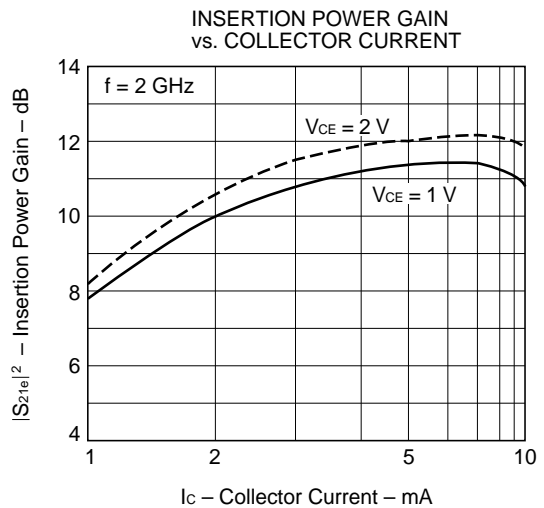
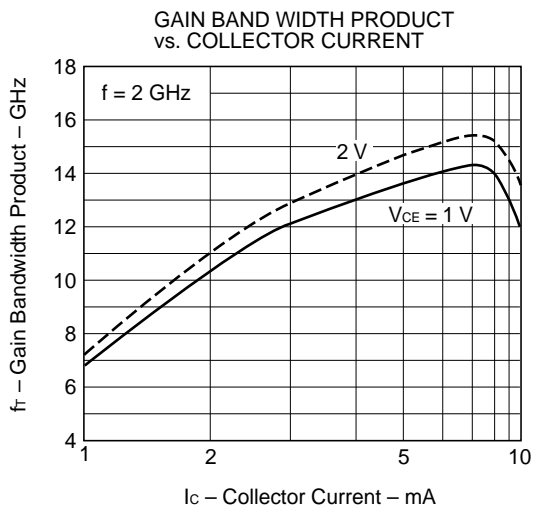
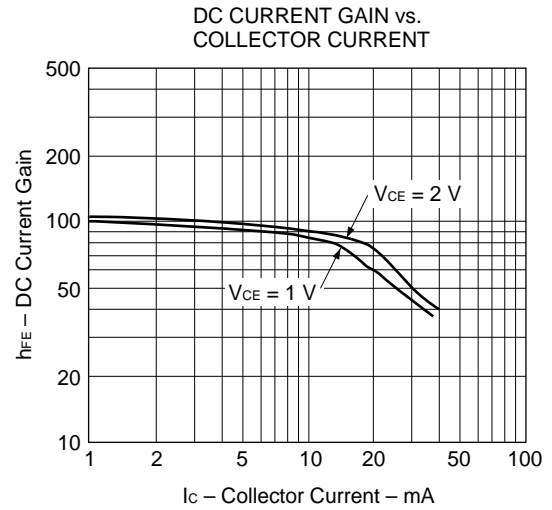
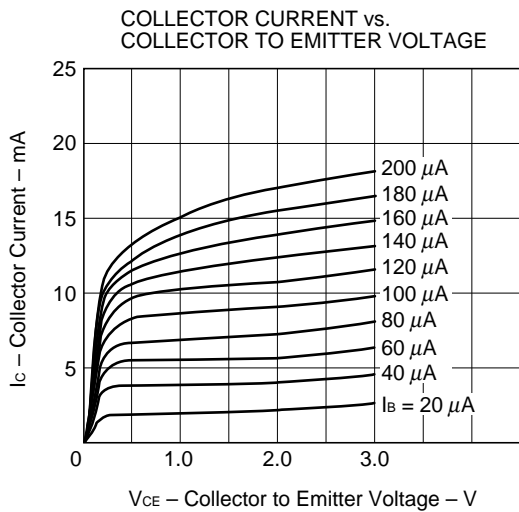
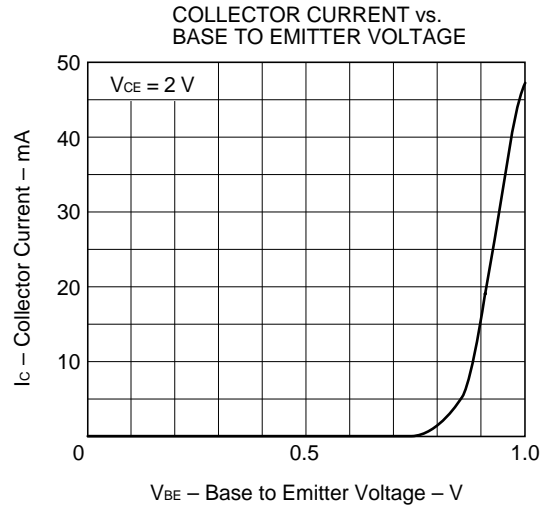
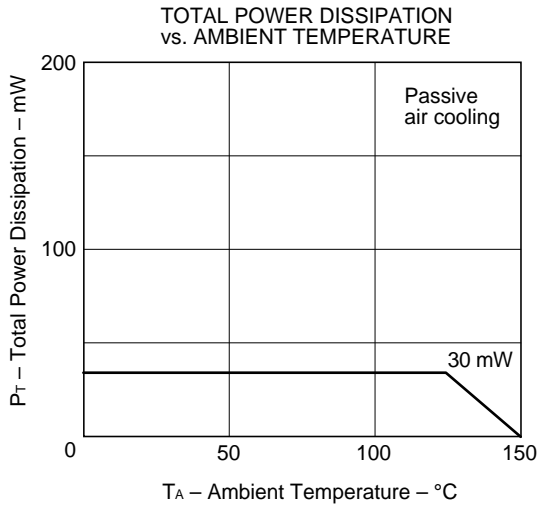

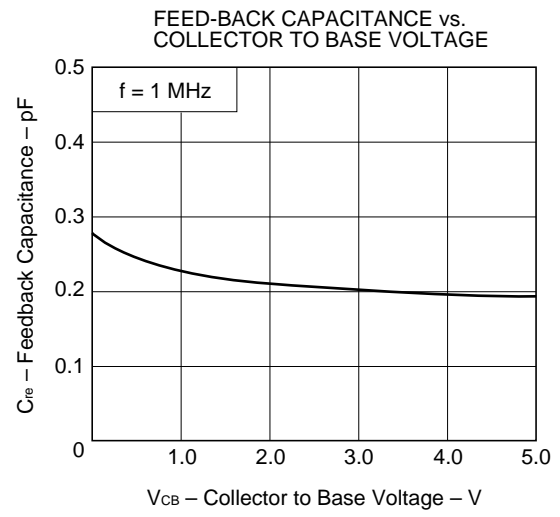
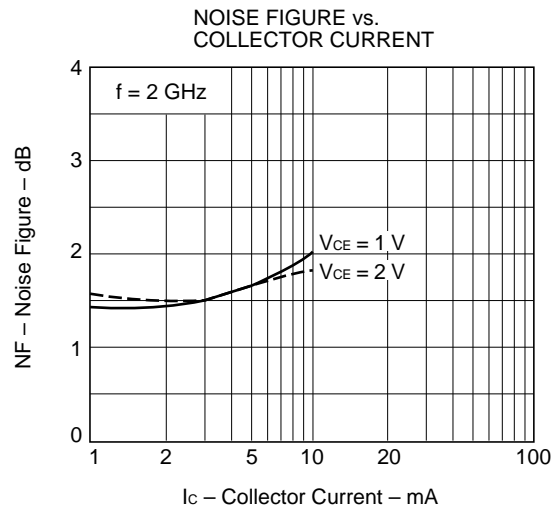

S-PARAMETER

V_{CE} = 1 V, I_c = 1 mA, Z_o = 50 Ω

FREQUENCY MHz	S11		S21		S12		S22	
	MAG	ANG	MAG	ANG	MAG	ANG	MAG	ANG
600.00	0.916	-28.0	3.247	147.1	0.074	65.6	0.960	-21.2
800.00	0.816	-36.9	3.092	136.2	0.111	58.6	0.887	-26.2
1000.00	0.741	-47.1	2.929	125.5	0.140	54.4	0.810	-32.8
1200.00	0.691	-55.8	2.864	116.5	0.158	52.2	0.788	-39.3
1400.00	0.628	-63.3	2.762	109.6	0.179	48.2	0.744	-44.5
1600.00	0.558	-72.3	2.590	100.9	0.195	44.8	0.692	-49.2
1800.00	0.508	-80.9	2.505	93.4	0.199	43.7	0.647	-54.7
2000.00	0.444	-87.8	2.293	88.1	0.196	39.5	0.602	-58.2
2200.00	0.386	-94.3	2.111	81.8	0.201	35.8	0.575	-61.2

V_{CE} = 1 V, I_c = 3 mA, Z_o = 50 Ω

FREQUENCY MHz	S11		S21		S12		S22	
	MAG	ANG	MAG	ANG	MAG	ANG	MAG	ANG
600.00	0.694	-43.6	6.614	129.7	0.063	57.9	0.819	-30.4
800.00	0.557	-54.5	5.730	117.1	0.090	54.4	0.707	-35.6
1000.00	0.463	-63.1	5.054	106.4	0.113	52.6	0.609	-41.1
1200.00	0.394	-70.7	4.628	99.0	0.125	54.2	0.575	-45.5
1400.00	0.325	-78.9	4.123	92.2	0.143	52.5	0.526	-48.8
1600.00	0.269	-88.2	3.744	84.3	0.157	51.5	0.478	-52.5
1800.00	0.226	-96.9	3.488	79.4	0.160	52.5	0.441	-57.0
2000.00	0.181	-103.5	3.085	75.5	0.166	50.8	0.412	-57.9
2200.00	0.146	-111.9	2.776	70.5	0.174	48.1	0.401	-60.0

V_{CE} = 1 V, I_c = 5 mA, Z_o = 50 Ω

FREQUENCY MHz	S11		S21		S12		S22	
	MAG	ANG	MAG	ANG	MAG	ANG	MAG	ANG
600.00	0.556	-51.5	7.925	120.8	0.055	57.5	0.729	-33.5
800.00	0.430	-61.6	6.573	108.7	0.083	55.0	0.614	-37.4
1000.00	0.338	-68.2	5.644	98.8	0.102	54.0	0.527	-41.0
1200.00	0.271	-75.3	5.047	92.4	0.117	57.7	0.498	-44.6
1400.00	0.217	-84.1	4.409	86.0	0.133	56.5	0.451	-47.5
1600.00	0.171	-94.6	3.985	78.8	0.148	55.9	0.414	-50.0
1800.00	0.137	-104.4	3.674	74.9	0.155	57.4	0.382	-53.9
2000.00	0.100	-114.7	3.229	71.4	0.162	55.7	0.361	-55.0
2200.00	0.079	-125.3	2.897	66.9	0.173	53.0	0.357	-57.2

V_{CE} = 1 V, I_c = 7 mA, Z_o = 50 Ω

FREQUENCY MHz	S11		S21		S12		S22	
	MAG	ANG	MAG	ANG	MAG	ANG	MAG	ANG
600.00	0.455	-57.2	8.518	114.4	0.051	56.0	0.657	-34.1
800.00	0.335	-67.4	6.873	103.1	0.075	55.1	0.557	-36.6
1000.00	0.252	-73.2	5.825	93.9	0.095	56.7	0.480	-39.2
1200.00	0.194	-80.5	5.131	88.3	0.113	59.7	0.453	-41.8
1400.00	0.148	-91.1	4.447	82.0	0.129	58.7	0.417	-44.6
1600.00	0.114	-105.9	4.018	75.3	0.145	58.7	0.385	-46.8
1800.00	0.087	-119.5	3.682	71.9	0.152	60.6	0.357	-50.6
2000.00	0.062	-140.8	3.230	68.6	0.161	58.1	0.341	-51.5
2200.00	0.051	-160.7	2.893	64.4	0.170	55.7	0.342	-54.0

V_{CE} = 1 V, I_c = 10 mA, Z_o = 50 Ω

FREQUENCY MHz	S11		S21		S12		S22	
	MAG	ANG	MAG	ANG	MAG	ANG	MAG	ANG
600.00	0.359	-65.9	8.500	108.9	0.048	54.8	0.603	-33.1
800.00	0.255	-78.2	6.731	98.1	0.071	56.3	0.516	-34.4
1000.00	0.177	-83.8	5.648	89.6	0.090	56.8	0.449	-35.9
1200.00	0.127	-96.6	4.927	84.4	0.109	61.7	0.431	-38.2
1400.00	0.098	-115.6	4.251	78.2	0.125	61.4	0.400	-40.5
1600.00	0.081	-141.9	3.839	71.9	0.143	61.2	0.377	-42.8
1800.00	0.072	-162.7	3.504	68.8	0.150	62.1	0.351	-46.1
2000.00	0.070	170.9	3.072	65.8	0.157	60.3	0.338	-47.5
2200.00	0.074	157.1	2.748	61.5	0.167	57.2	0.342	-50.4

V_{CE} = 2 V, I_c = 1 mA, Z_o = 50 Ω

FREQUENCY MHz	S11		S21		S12		S22	
	MAG	ANG	MAG	ANG	MAG	ANG	MAG	ANG
600.00	0.927	-26.3	3.263	148.6	0.065	64.5	0.968	-19.5
800.00	0.827	-34.2	3.122	138.1	0.101	59.7	0.903	-24.1
1000.00	0.758	-43.7	2.962	127.7	0.129	54.9	0.828	-30.3
1200.00	0.712	-52.2	2.910	118.9	0.146	54.2	0.808	-36.5
1400.00	0.653	-59.1	2.825	112.3	0.165	50.6	0.769	-41.3
1600.00	0.581	-67.5	2.657	103.8	0.181	47.3	0.723	-46.0
1800.00	0.530	-75.7	2.578	96.3	0.185	46.0	0.673	-51.3
2000.00	0.469	-82.1	2.368	91.0	0.184	41.5	0.630	-54.7
2200.00	0.410	-87.5	2.184	84.7	0.188	38.2	0.607	-57.4

V_{CE} = 2 V, I_c = 3 mA, Z_o = 50 Ω

FREQUENCY MHz	S11		S21		S12		S22	
	MAG	ANG	MAG	ANG	MAG	ANG	MAG	ANG
600.00	0.727	-39.7	6.761	131.7	0.057	58.1	0.841	-27.8
800.00	0.587	-49.7	5.910	119.4	0.084	55.8	0.737	-32.4
1000.00	0.490	-57.4	5.229	108.8	0.104	54.2	0.645	-37.5
1200.00	0.425	-64.5	4.812	101.3	0.120	55.7	0.608	-41.8
1400.00	0.354	-70.8	4.314	94.8	0.135	55.3	0.562	-45.1
1600.00	0.295	-78.5	3.919	86.9	0.148	54.1	0.517	-48.3
1800.00	0.251	-85.1	3.662	81.8	0.151	54.8	0.478	-52.4
2000.00	0.203	-89.4	3.243	77.9	0.156	52.9	0.449	-53.6
2200.00	0.167	-93.9	2.924	73.0	0.164	50.9	0.441	-55.6

V_{CE} = 2 V, I_c = 5 mA, Z_o = 50 Ω

FREQUENCY MHz	S11		S21		S12		S22	
	MAG	ANG	MAG	ANG	MAG	ANG	MAG	ANG
600.00	0.592	-46.3	8.189	122.9	0.052	59.4	0.763	-30.6
800.00	0.457	-55.1	6.849	110.9	0.074	56.6	0.655	-33.8
1000.00	0.369	-60.0	5.900	101.1	0.096	54.1	0.564	-37.6
1200.00	0.305	-66.2	5.303	94.7	0.111	58.0	0.533	-40.7
1400.00	0.249	-72.3	4.651	88.4	0.126	58.2	0.495	-43.3
1600.00	0.198	-79.2	4.202	81.2	0.139	58.2	0.460	-45.6
1800.00	0.160	-85.2	3.888	77.2	0.146	59.2	0.425	-59.3
2000.00	0.121	-89.1	3.419	73.8	0.151	57.5	0.404	-50.4
2200.00	0.096	-92.3	3.069	69.3	0.161	54.4	0.403	-52.2

$V_{CE} = 2\text{ V}$, $I_c = 7\text{ mA}$, $Z_o = 50\ \Omega$

FREQUENCY MHz	S11		S21		S12		S22	
	MAG	ANG	MAG	ANG	MAG	ANG	MAG	ANG
600.00	0.489	-50.8	8.917	116.7	0.045	58.5	0.701	-31.1
800.00	0.371	-58.8	7.266	105.4	0.070	57.0	0.601	-33.3
1000.00	0.287	-62.3	6.166	96.2	0.090	57.4	0.523	-35.7
1200.00	0.233	-67.2	5.456	90.6	0.106	61.2	0.501	-38.3
1400.00	0.181	-72.6	4.743	84.5	0.122	62.0	0.465	-40.4
1600.00	0.138	-80.1	4.283	77.7	0.137	61.2	0.436	-42.7
1800.00	0.105	-86.5	3.937	74.2	0.143	62.8	0.404	-45.9
2000.00	0.072	-91.2	3.456	71.1	0.149	60.2	0.389	-47.1
2200.00	0.052	-93.0	3.097	66.9	0.159	57.3	0.391	-49.2

$V_{CE} = 2\text{ V}$, $I_c = 10\text{ mA}$, $Z_o = 50\ \Omega$

FREQUENCY MHz	S11		S21		S12		S22	
	MAG	ANG	MAG	ANG	MAG	ANG	MAG	ANG
600.00	0.404	-55.4	9.236	111.8	0.039	55.3	0.660	-30.2
800.00	0.298	-62.9	7.374	101.0	0.064	57.2	0.569	-31.4
1000.00	0.221	-65.2	6.206	92.5	0.087	60.1	0.501	-33.0
1200.00	0.169	-69.5	5.441	87.4	0.102	63.5	0.483	-35.3
1400.00	0.128	-76.3	4.701	81.4	0.119	63.3	0.456	-37.4
1600.00	0.089	-86.1	4.244	75.0	0.134	63.5	0.430	-39.5
1800.00	0.062	-96.1	3.888	71.9	0.140	64.0	0.400	-42.5
2000.00	0.035	-112.1	3.408	68.9	0.147	62.4	0.388	-43.8
2200.00	0.021	-121.3	3.050	64.8	0.156	59.6	0.393	-46.2

No part of this document may be copied or reproduced in any form or by any means without the prior written consent of NEC Corporation. NEC Corporation assumes no responsibility for any errors which may appear in this document.

NEC Corporation does not assume any liability for infringement of patents, copyrights or other intellectual property rights of third parties by or arising from use of a device described herein or any other liability arising from use of such device. No license, either express, implied or otherwise, is granted under any patents, copyrights or other intellectual property rights of NEC Corporation or others.

While NEC Corporation has been making continuous effort to enhance the reliability of its semiconductor devices, the possibility of defects cannot be eliminated entirely. To minimize risks of damage or injury to persons or property arising from a defect in an NEC semiconductor device, customers must incorporate sufficient safety measures in its design, such as redundancy, fire-containment, and anti-failure features.

NEC devices are classified into the following three quality grades:

"Standard", "Special", and "Specific". The Specific quality grade applies only to devices developed based on a customer designated "quality assurance program" for a specific application. The recommended applications of a device depend on its quality grade, as indicated below. Customers must check the quality grade of each device before using it in a particular application.

Standard: Computers, office equipment, communications equipment, test and measurement equipment, audio and visual equipment, home electronic appliances, machine tools, personal electronic equipment and industrial robots

Special: Transportation equipment (automobiles, trains, ships, etc.), traffic control systems, anti-disaster systems, anti-crime systems, safety equipment and medical equipment (not specifically designed for life support)

Specific: Aircrafts, aerospace equipment, submersible repeaters, nuclear reactor control systems, life support systems or medical equipment for life support, etc.

The quality grade of NEC devices is "Standard" unless otherwise specified in NEC's Data Sheets or Data Books. If customers intend to use NEC devices for applications other than those specified for Standard quality grade, they should contact an NEC sales representative in advance.

Anti-radioactive design is not implemented in this product.