

TOSHIBA TRANSISTOR SILICON NPN EPITAXIAL PLANAR TYPE

2SC5107

FOR VCO APPLICATION

Unit in mm

MAXIMUM RATINGS (Ta = 25°C)

CHARACTERISTIC	SYMBOL	RATING	UNIT
Collector-Base Voltage	V _{CB0}	20	V
Collector-Emitter Voltage	V _{CEO}	10	V
Emitter-Base Voltage	V _{EBO}	3	V
Base Current	I _B	15	mA
Collector Current	I _C	30	mA
Collector Power Dissipation	P _C	100	mW
Junction Temperature	T _j	125	°C
Storage Temperature Range	T _{stg}	-55~125	°C

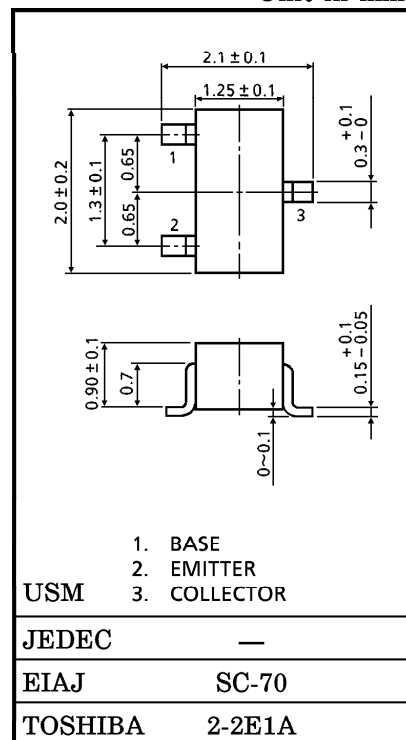

MARKING

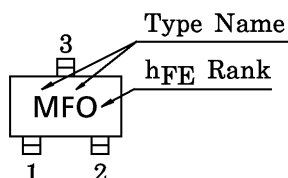

Weight : 0.006g

ELECTRICAL CHARACTERISTICS (Ta = 25°C)

CHARACTERISTIC	SYMBOL	TEST CONDITION	MIN.	TYP.	MAX.	UNIT
Collector Cut-off Current	I _{CB0}	V _{CB} = 10V, I _E = 0	—	—	0.1	μA
Emitter Cut-off Current	I _{EBO}	V _{EB} = 1V, I _C = 0	—	—	0.1	μA
DC Current Gain	h _{FE} (Note 1)	V _{CE} = 5V, I _C = 5mA	80	—	240	—
Transition Frequency	f _T	V _{CE} = 5V, I _C = 5mA	4	6	—	GHz
Insertion Gain	S _{21e} ²	V _{CE} = 5V, I _C = 5mA, f = 1GHz	7	11	—	dB
Output Capacitance	C _{ob}	V _{CB} = 5V, I _E = 0, f = 1MHz (Note 2)	—	0.7	—	pF
Reverse Transfer Capacitance	C _{re}		—	0.5	0.9	pF
Collector-Base Time Constant	C _c ·r _{bb} '	V _{CB} = 5V, I _C = 3mA, f = 30MHz	—	5.5	10	ps

(Note 1) h_{FE} Classification O : 80~160, Y : 120~240

(Note 2) C_{re} is measured by 3 terminal method with capacitance bridge.

961001EAA1

- TOSHIBA is continually working to improve the quality and the reliability of its products. Nevertheless, semiconductor devices in general can malfunction or fail due to their inherent electrical sensitivity and vulnerability to physical stress. It is the responsibility of the buyer, when utilizing TOSHIBA products, to observe standards of safety, and to avoid situations in which a malfunction or failure of a TOSHIBA product could cause loss of human life, bodily injury or damage to property. In developing your designs, please ensure that TOSHIBA products are used within specified operating ranges as set forth in the most recent products specifications. Also, please keep in mind the precautions and conditions set forth in the TOSHIBA Semiconductor Reliability Handbook.
- The information contained herein is presented only as a guide for the applications of our products. No responsibility is assumed by TOSHIBA CORPORATION for any infringements of intellectual property or other rights of the third parties which may result from its use. No license is granted by implication or otherwise under any intellectual property or other rights of TOSHIBA CORPORATION or others.
- The information contained herein is subject to change without notice.

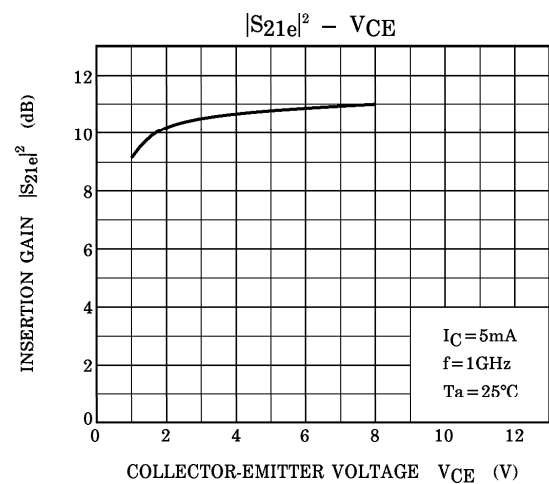
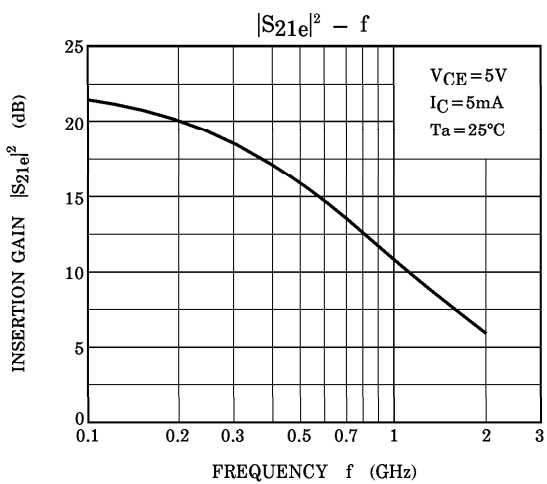
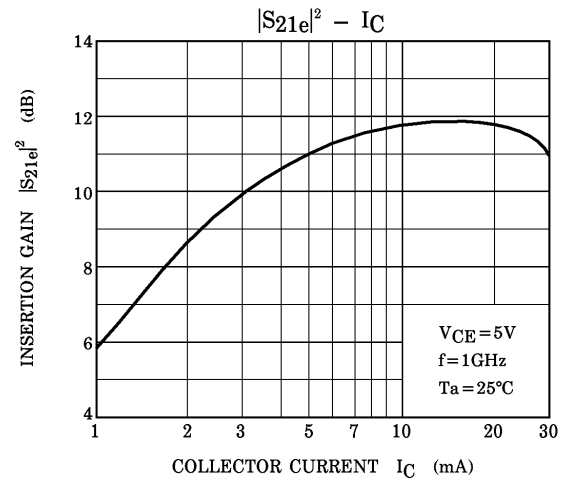
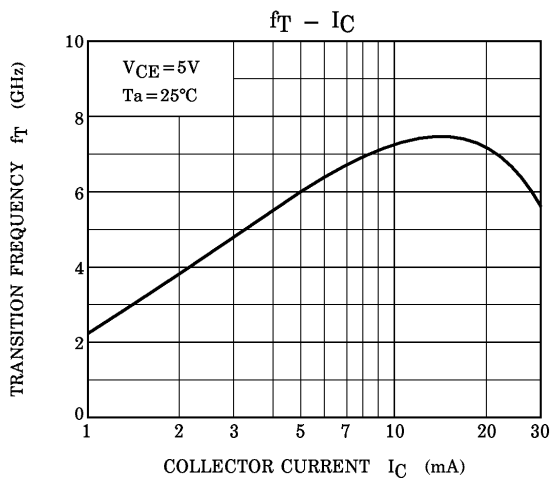
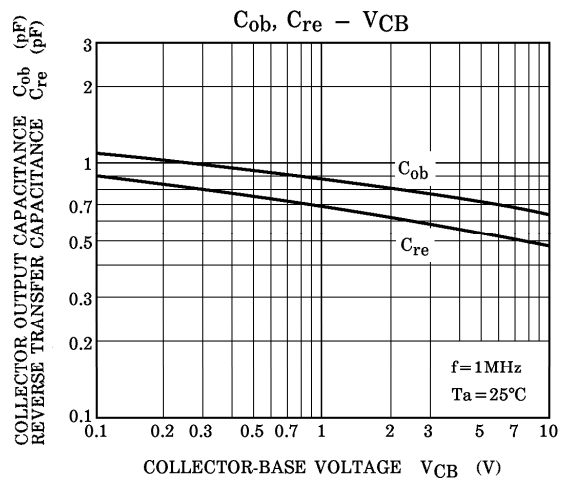
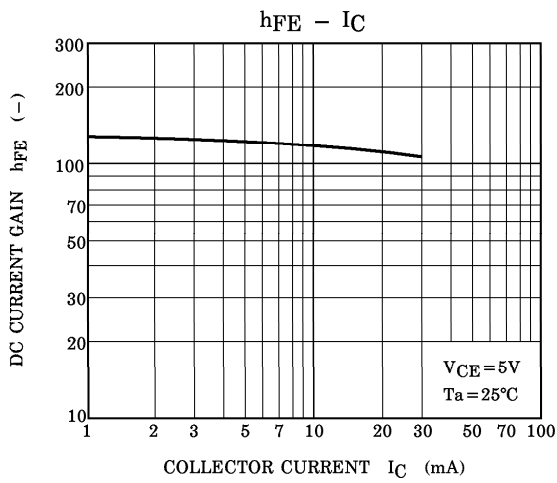

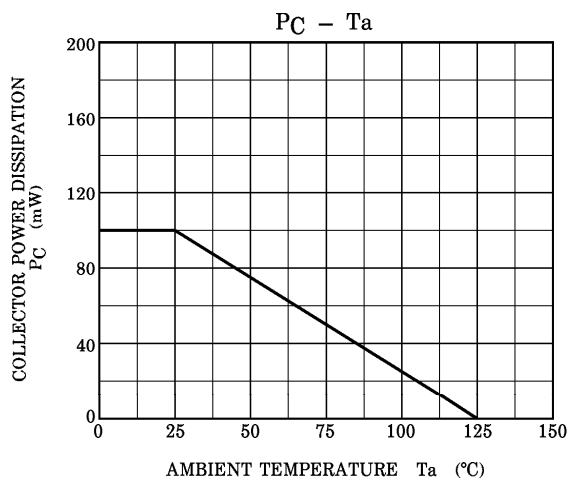

S-Parameter $Z_0 = 50\Omega$, $T_a = 25^\circ\text{C}$
 $V_{CE} = 5\text{V}$, $I_C = 5\text{mA}$

周波数 (MHz)	S11		S21		S12		S22	
	Mag.	Ang.	Mag.	Ang.	Mag.	Ang.	Mag.	Ang.
200	0.684	-47.0	10.116	136.8	0.049	63.1	0.765	-29.5
400	0.438	-79.2	7.260	112.9	0.072	56.5	0.553	-37.8
600	0.301	-101.2	5.388	99.1	0.090	56.5	0.452	-39.1
800	0.226	-119.2	4.227	90.0	0.107	57.6	0.402	-39.0
1000	0.182	-136.2	3.494	82.7	0.124	58.8	0.374	-38.9
1200	0.159	-153.3	2.988	76.9	0.142	59.6	0.359	-39.4
1400	0.147	-170.3	2.632	71.2	0.163	59.9	0.348	-40.7
1600	0.145	174.4	2.345	66.0	0.182	59.2	0.339	-43.2
1800	0.149	162.6	2.128	61.4	0.200	58.4	0.329	-46.3
2000	0.161	150.9	1.967	57.1	0.219	58.1	0.318	-49.5

S_{11e}
 V_{CE}=5V
 I_C=5mA
 T_a=25°C
 (UNIT : Ω)

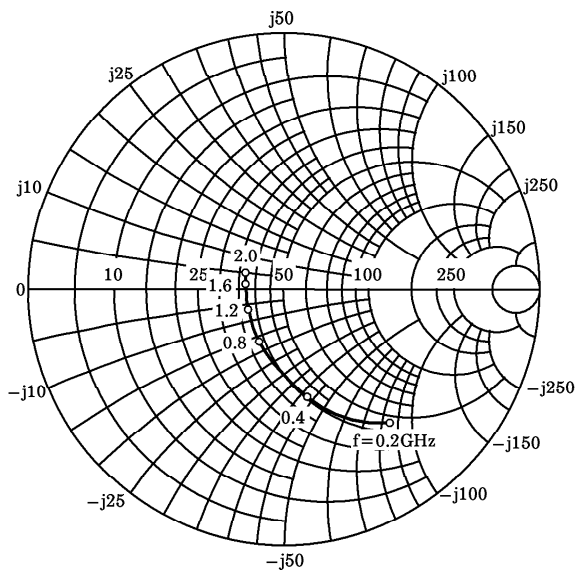

S_{21e}
 V_{CE}=5V
 I_C=5mA
 T_a=25°C

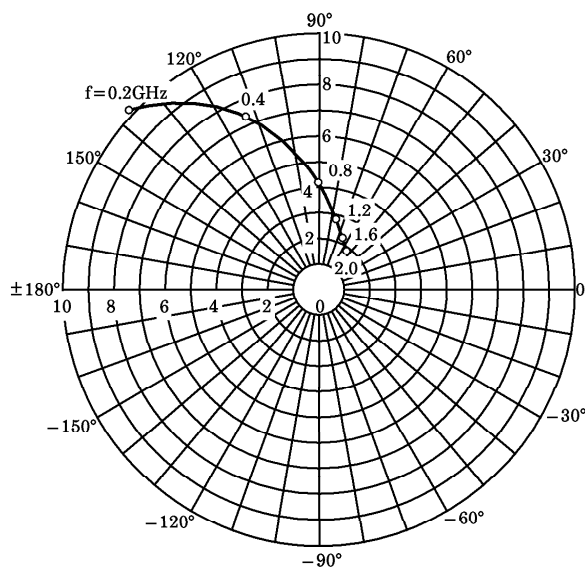

S_{12e}
 V_{CE}=5V
 I_C=5mA
 T_a=25°C

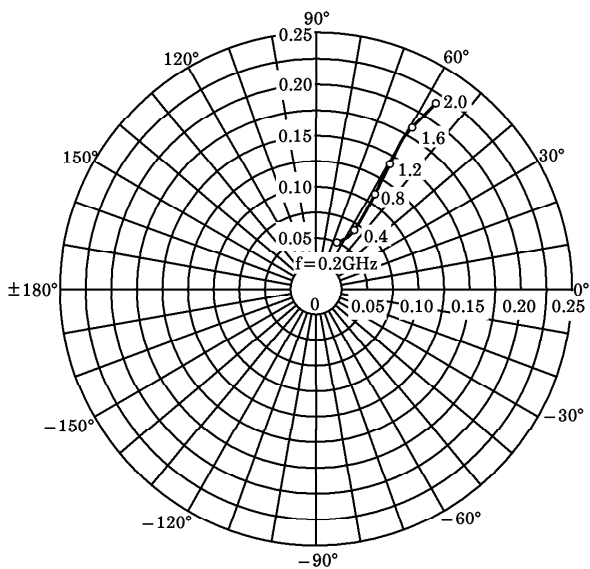

S_{22e}
 V_{CE}=5V
 I_C=5mA
 T_a=25°C
 (UNIT : Ω)

