

TOSHIBA TRANSISTOR SILICON NPN EPITAXIAL PLANAR TYPE

2SC5095

VHF~UHF BAND LOW NOISE AMPLIFIER APPLICATIONS

Unit in mm

- Low Noise Figure, High Gain.
- $NF=1.8dB$, $|S_{21e}|^2=7.5dB$ ($f=2GHz$)

MAXIMUM RATINGS ($T_a = 25^\circ C$)

CHARACTERISTIC	SYMBOL	RATING	UNIT
Collector-Base Voltage	V_{CBO}	20	V
Collector-Emitter Voltage	V_{CEO}	10	V
Emitter-Base Voltage	V_{EBO}	1.5	V
Base Current	I_B	7	mA
Collector Current	I_C	15	mA
Collector Power Dissipation	P_C	100	mW
Junction Temperature	T_j	125	$^\circ C$
Storage Temperature Range	T_{stg}	-55~125	$^\circ C$

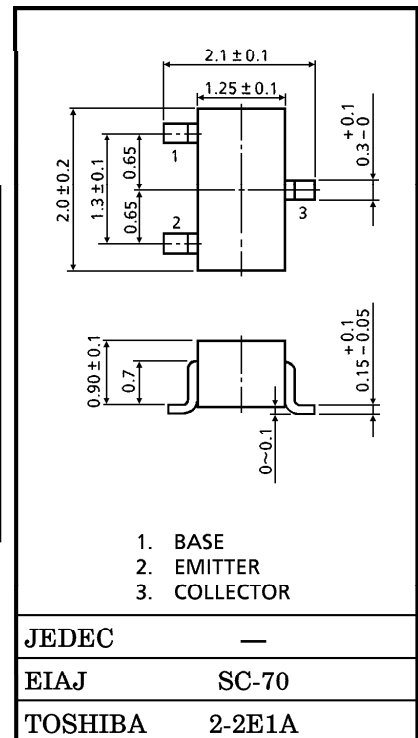

Weight : 0.006g

MARKING

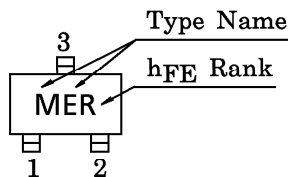

MICROWAVE CHARACTERISTICS ($T_a = 25^\circ C$)

CHARACTERISTIC	SYMBOL	TEST CONDITION	MIN.	TYP.	MAX.	UNIT
Transition Frequency	f_T	$V_{CE}=6V, I_C=7mA$	7	10	—	GHz
Insertion Gain	$ S_{21e} ^2 (1)$	$V_{CE}=6V, I_C=7mA, f=1GHz$	—	13	—	dB
	$ S_{21e} ^2 (2)$	$V_{CE}=6V, I_C=7mA, f=2GHz$	4.5	7.5	—	
Noise Figure	NF (1)	$V_{CE}=6V, I_C=3mA, f=1GHz$	—	1.4	—	dB
	NF (2)	$V_{CE}=6V, I_C=3mA, f=2GHz$	—	1.8	3.0	

ELECTRICAL CHARACTERISTICS ($T_a = 25^\circ C$)

CHARACTERISTIC	SYMBOL	TEST CONDITION	MIN.	TYP.	MAX.	UNIT
Collector Cut-off Current	I_{CBO}	$V_{CB}=10V, I_E=0$	—	—	1	μA
Emitter Cut-off Current	I_{EBO}	$V_{EB}=1V, I_C=0$	—	—	1	μA
DC Current Gain	h_{FE} (Note 1)	$V_{CE}=6V, I_C=7mA$	50	—	160	—
Output Capacitance	C_{ob}	$V_{CB}=10V, I_E=0, f=1MHz$	—	0.5	—	pF
Reverse Transfer Capacitance	C_{re}		(Note 2)	—	0.4	0.85

(Note 1) h_{FE} Classification R : 50~100, O : 80~160

(Note 2) C_{re} is measured by 3 terminal method with capacitance bridge.

961001EAA2

- TOSHIBA is continually working to improve the quality and the reliability of its products. Nevertheless, semiconductor devices in general can malfunction or fail due to their inherent electrical sensitivity and vulnerability to physical stress. It is the responsibility of the buyer, when utilizing TOSHIBA products, to observe standards of safety, and to avoid situations in which a malfunction or failure of a TOSHIBA product could cause loss of human life, bodily injury or damage to property. In developing your designs, please ensure that TOSHIBA products are used within specified operating ranges as set forth in the most recent products specifications. Also, please keep in mind the precautions and conditions set forth in the TOSHIBA Semiconductor Reliability Handbook.
- The information contained herein is presented only as a guide for the applications of our products. No responsibility is assumed by TOSHIBA CORPORATION for any infringements of intellectual property or other rights of the third parties which may result from its use. No license is granted by implication or otherwise under any intellectual property or other rights of TOSHIBA CORPORATION or others.
- The information contained herein is subject to change without notice.

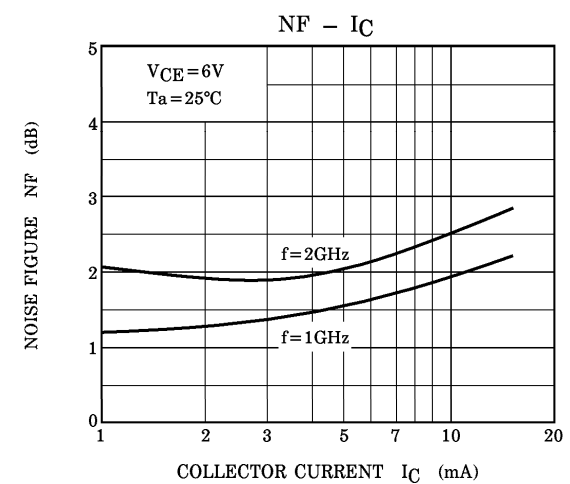
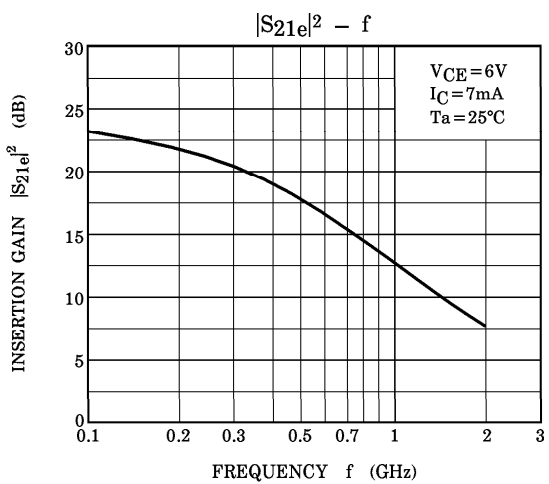
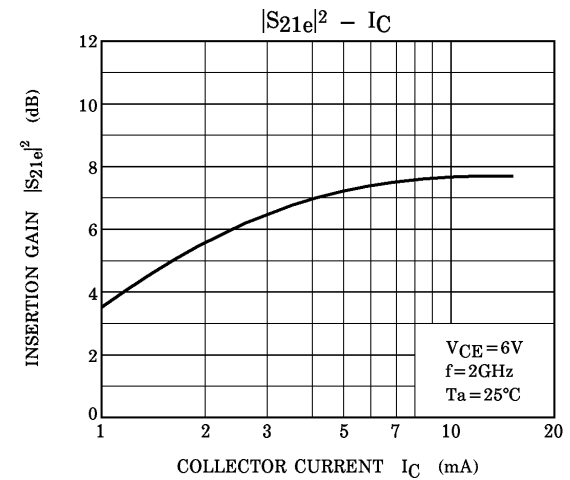
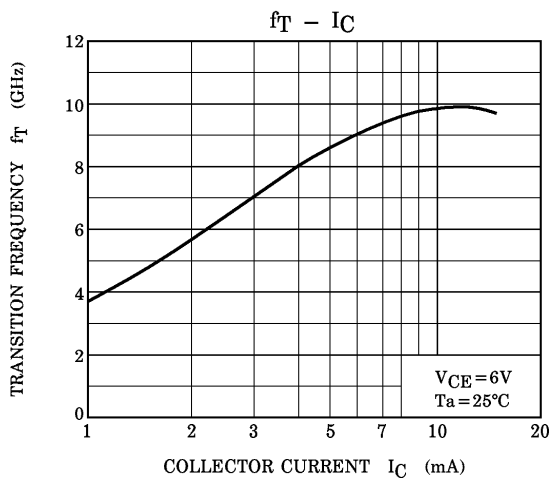
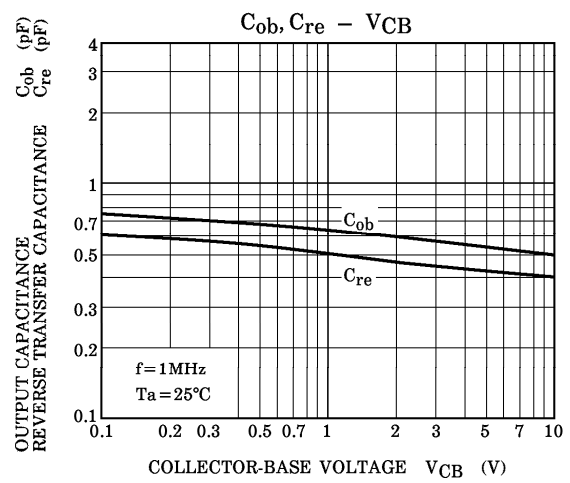
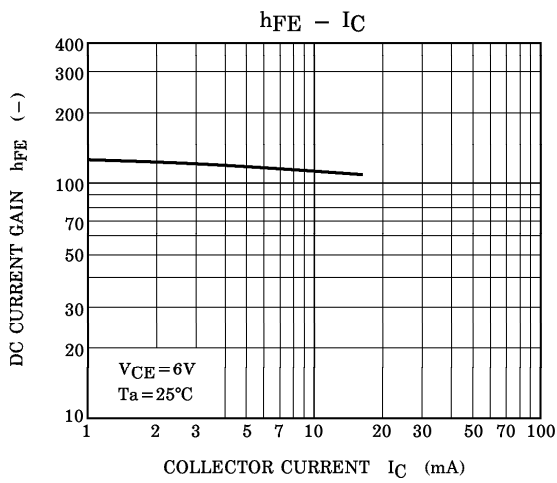

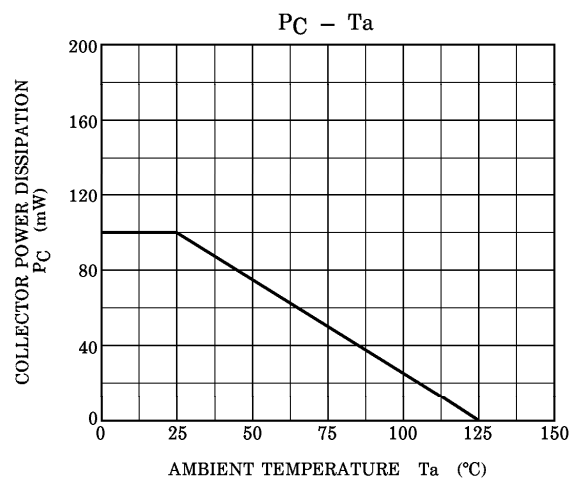
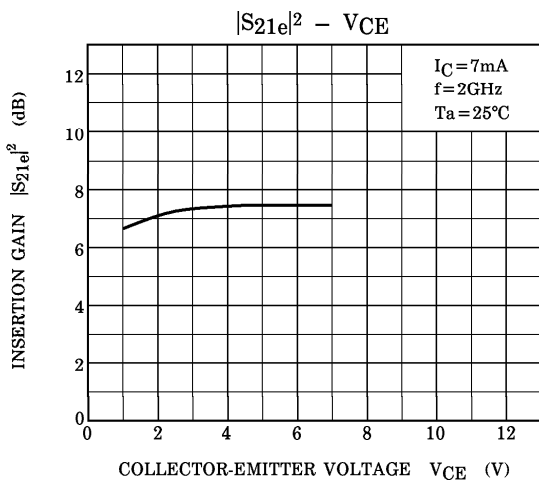

S-Parameter $Z_0 = 50\Omega$, $T_a = 25^\circ\text{C}$
 $V_{CE} = 6\text{V}$, $I_C = 3\text{mA}$

frequency (MHz)	S11		S21		S12		S22	
	Mag.	Ang.	Mag.	Ang.	Mag.	Ang.	Mag.	Ang.
200	0.835	-26.1	7.069	150.4	0.046	71.0	0.899	-19.3
400	0.665	-46.5	5.948	130.4	0.076	60.5	0.745	-30.3
600	0.501	-62.7	5.021	115.2	0.095	55.7	0.630	-35.9
800	0.386	-74.3	4.173	104.3	0.111	53.7	0.552	-38.5
1000	0.297	-83.7	3.592	95.6	0.124	53.2	0.500	-39.9
1200	0.226	-92.7	3.140	88.5	0.137	53.6	0.465	-41.1
1400	0.175	-101.9	2.808	82.3	0.152	54.1	0.442	-42.2
1600	0.130	-113.4	2.514	76.6	0.165	54.2	0.421	-43.8
1800	0.103	-128.0	2.293	71.7	0.179	53.9	0.405	-45.7
2000	0.081	-147.4	2.114	67.3	0.193	54.8	0.388	-47.4

$V_{CE} = 6\text{V}$, $I_C = 7\text{mA}$

frequency (MHz)	S11		S21		S12		S22	
	Mag.	Ang.	Mag.	Ang.	Mag.	Ang.	Mag.	Ang.
200	0.668	-40.0	12.306	138.9	0.040	67.3	0.786	-27.0
400	0.427	-64.4	8.852	116.1	0.061	61.6	0.579	-35.0
600	0.280	-79.5	6.591	102.9	0.078	61.8	0.476	-35.9
800	0.193	-89.7	5.191	94.3	0.096	62.5	0.420	-35.0
1000	0.134	-99.3	4.288	87.8	0.112	63.2	0.390	-34.2
1200	0.088	-112.3	3.661	81.9	0.130	63.8	0.374	-34.0
1400	0.056	-129.8	3.232	76.9	0.150	63.4	0.366	-34.8
1600	0.035	-169.0	2.857	72.1	0.168	62.5	0.356	-36.6
1800	0.040	157.0	2.574	68.1	0.185	61.4	0.347	-39.0
2000	0.054	131.5	2.363	64.3	0.203	61.3	0.338	-40.2

S_{11e}
 V_{CE} = 6V
 I_C = 3mA
 T_a = 25°C
 (UNIT : Ω)

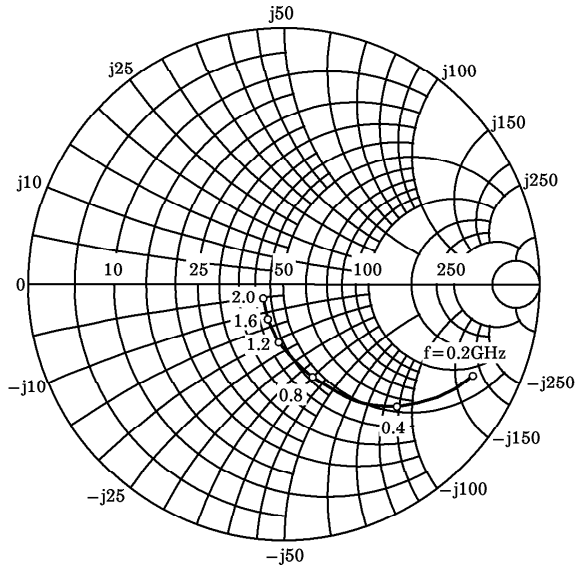

S_{21e}
 V_{CE} = 6V
 I_C = 3mA
 T_a = 25°C

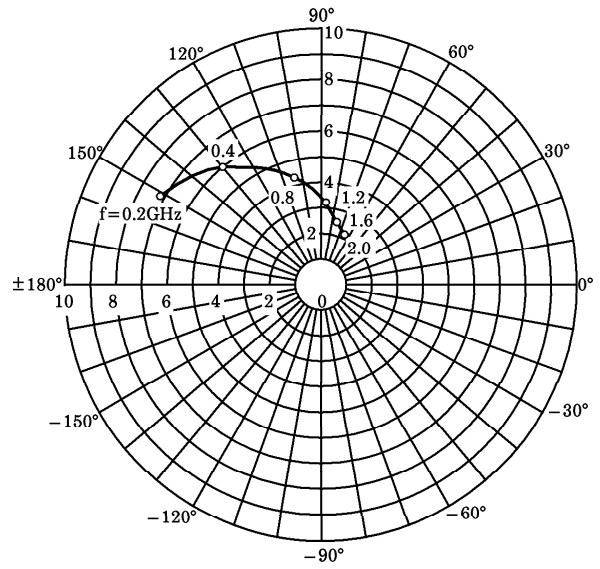

S_{12e}
 V_{CE} = 6V
 I_C = 7mA
 T_a = 25°C

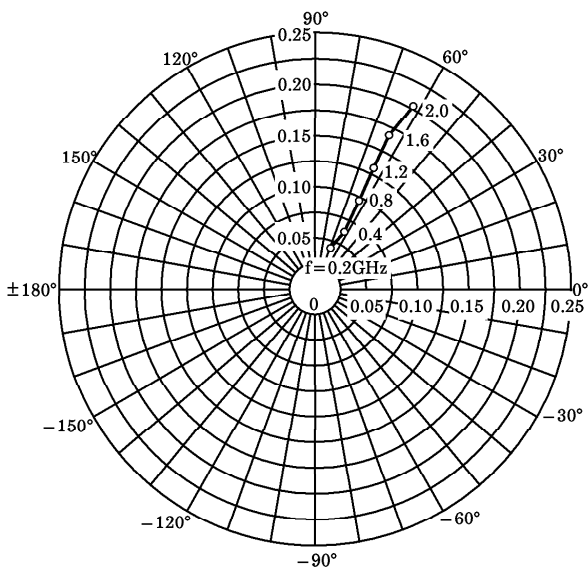

S_{22e}
 V_{CE} = 6V
 I_C = 7mA
 T_a = 25°C
 (UNIT : Ω)

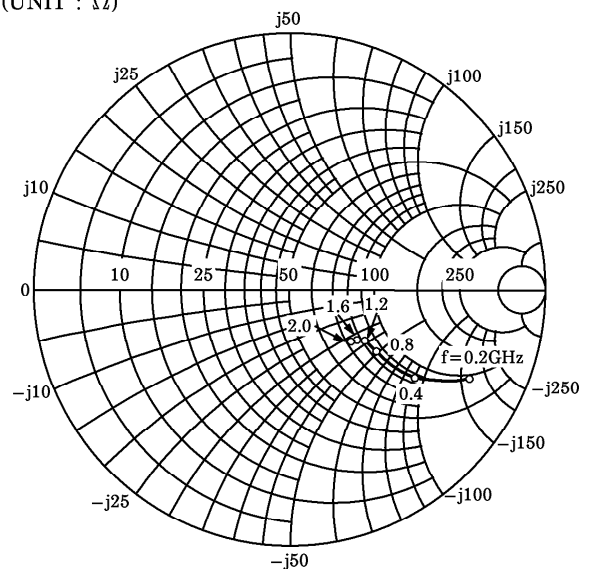

S_{11e}
 V_{CE}=6V
 I_C=7mA
 T_a=25°C
 (UNIT : Ω)

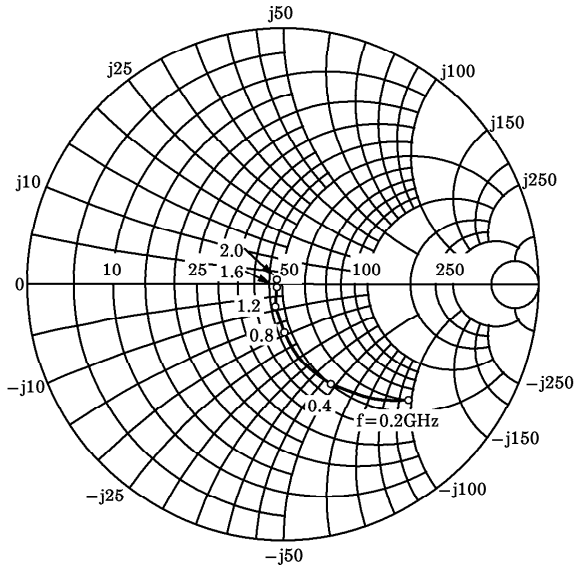

S_{21e}
 V_{CE}=6V
 I_C=7mA
 T_a=25°C

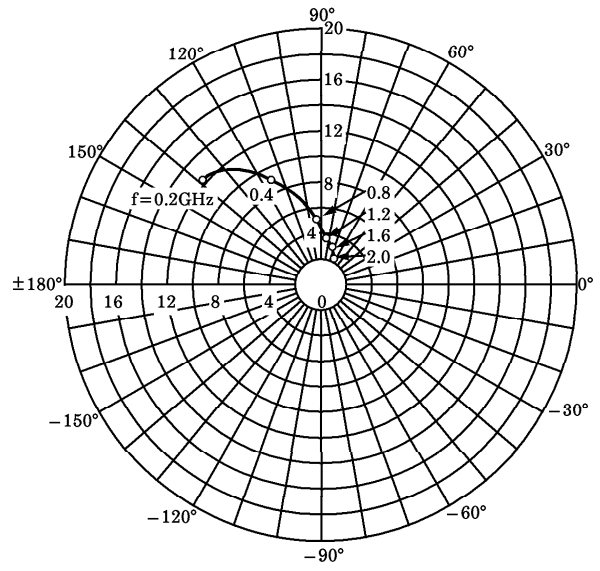

S_{12e}
 V_{CE}=6V
 I_C=3mA
 T_a=25°C

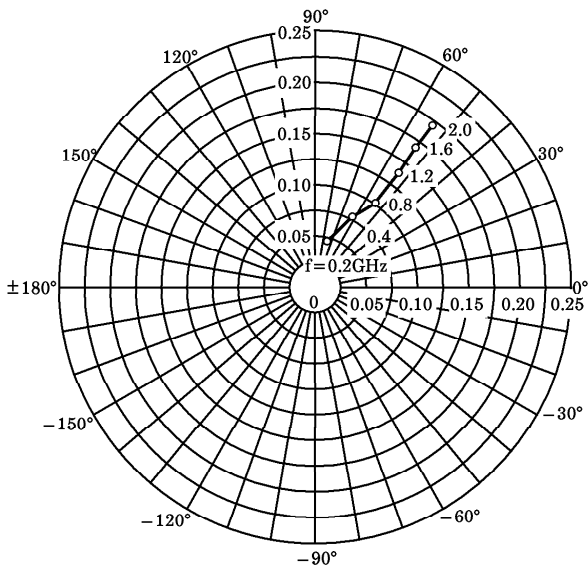

S_{22e}
 V_{CE}=6V
 I_C=3mA
 T_a=25°C
 (UNIT : Ω)

