

TOSHIBA TRANSISTOR SILICON NPN EPITAXIAL PLANAR TYPE

# 2SC5094

VHF~UHF BAND LOW NOISE AMPLIFIER APPLICATIONS

Unit in mm

- Low Noise Figure, High Gain.
- $NF=1.8dB$ ,  $|S_{21e}|^2=7.5dB$  ( $f=2GHz$ )

MAXIMUM RATINGS ( $T_a = 25^\circ C$ )

CHARACTERISTIC	SYMBOL	RATING	UNIT
Collector-Base Voltage	$V_{CBO}$	20	V
Collector-Emitter Voltage	$V_{CEO}$	10	V
Emitter-Base Voltage	$V_{EBO}$	1.5	V
Base Current	$I_B$	7	mA
Collector Current	$I_C$	15	mA
Collector Power Dissipation	$P_C$	150	mW
Junction Temperature	$T_j$	125	$^\circ C$
Storage Temperature Range	$T_{stg}$	-55~125	$^\circ C$

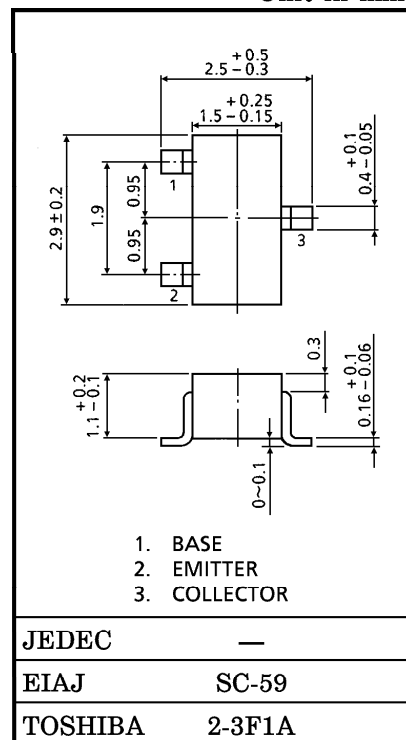

Weight : 0.012g

MARKING

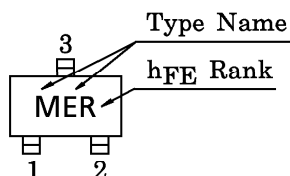

MICROWAVE CHARACTERISTICS ( $T_a = 25^\circ C$ )

CHARACTERISTIC	SYMBOL	TEST CONDITION	MIN.	TYP.	MAX.	UNIT
Transition Frequency	$f_T$	$V_{CE}=6V, I_C=7mA$	7	10	—	GHz
Insertion Gain	$ S_{21e} ^2 (1)$	$V_{CE}=6V, I_C=7mA, f=1GHz$	—	13	—	dB
	$ S_{21e} ^2 (2)$	$V_{CE}=6V, I_C=7mA, f=2GHz$	4.5	7.5	—	
Noise Figure	NF (1)	$V_{CE}=6V, I_C=3mA, f=1GHz$	—	1.4	—	dB
	NF (2)	$V_{CE}=6V, I_C=3mA, f=2GHz$	—	1.8	3.0	

ELECTRICAL CHARACTERISTICS ( $T_a = 25^\circ C$ )

CHARACTERISTIC	SYMBOL	TEST CONDITION	MIN.	TYP.	MAX.	UNIT
Collector Cut-off Current	$I_{CBO}$	$V_{CB}=10V, I_E=0$	—	—	1	$\mu A$
Emitter Cut-off Current	$I_{EBO}$	$V_{EB}=1V, I_C=0$	—	—	1	$\mu A$
DC Current Gain	$h_{FE}$ (Note 1)	$V_{CE}=6V, I_C=7mA$	50	—	160	—
Output Capacitance	$C_{ob}$	$V_{CB}=10V, I_E=0, f=1MHz$	—	0.5	—	pF
Reverse Transfer Capacitance	$C_{re}$		(Note 2)	—	0.4	0.85

(Note 1)  $h_{FE}$  Classification R : 50~100, O : 80~160

(Note 2)  $C_{re}$  is measured by 3 terminal method with capacitance bridge.

961001EAA2

- TOSHIBA is continually working to improve the quality and the reliability of its products. Nevertheless, semiconductor devices in general can malfunction or fail due to their inherent electrical sensitivity and vulnerability to physical stress. It is the responsibility of the buyer, when utilizing TOSHIBA products, to observe standards of safety, and to avoid situations in which a malfunction or failure of a TOSHIBA product could cause loss of human life, bodily injury or damage to property. In developing your designs, please ensure that TOSHIBA products are used within specified operating ranges as set forth in the most recent products specifications. Also, please keep in mind the precautions and conditions set forth in the TOSHIBA Semiconductor Reliability Handbook.
- The information contained herein is presented only as a guide for the applications of our products. No responsibility is assumed by TOSHIBA CORPORATION for any infringements of intellectual property or other rights of the third parties which may result from its use. No license is granted by implication or otherwise under any intellectual property or other rights of TOSHIBA CORPORATION or others.
- The information contained herein is subject to change without notice.

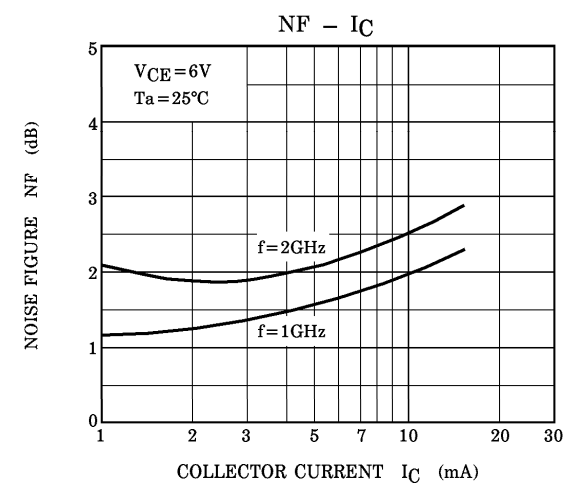
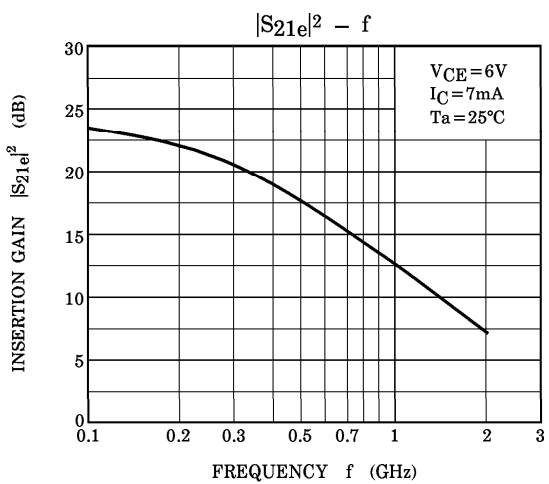
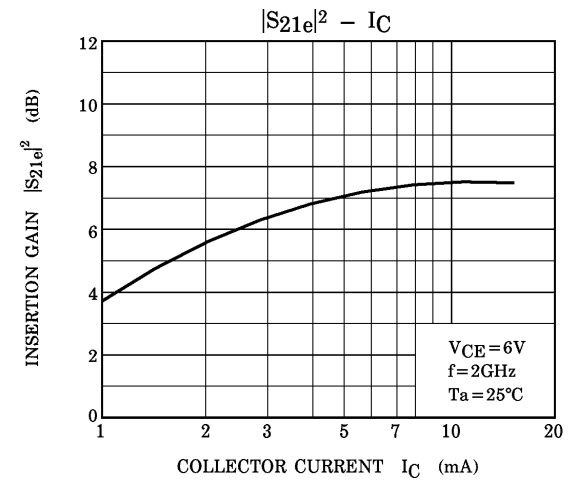
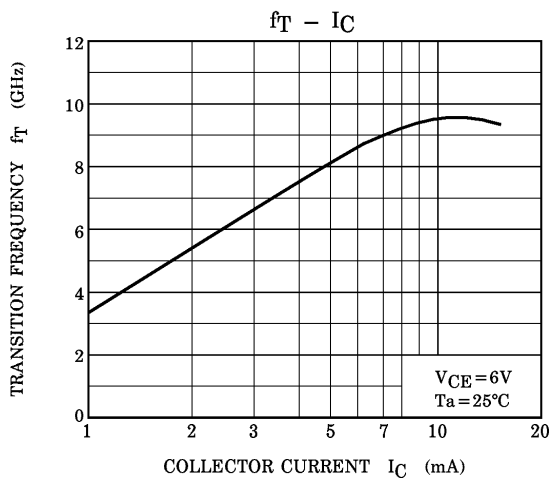
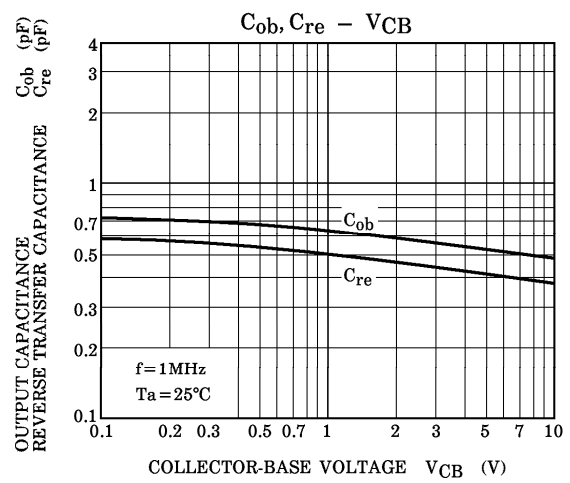
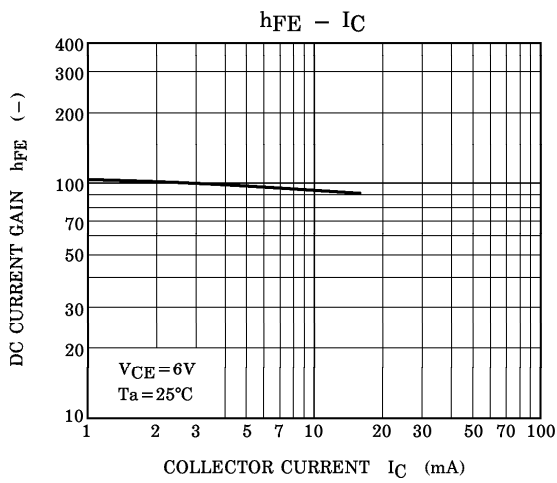

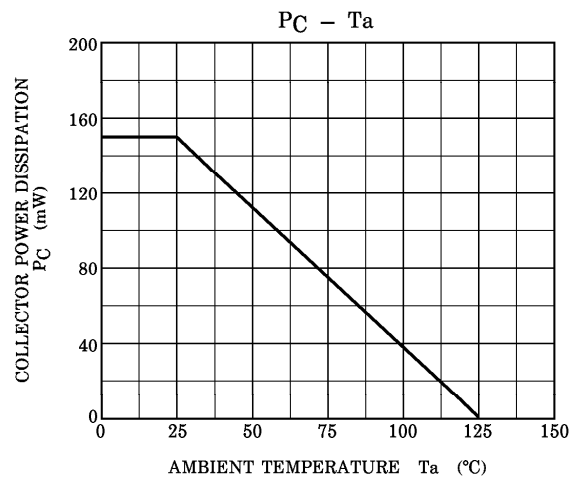
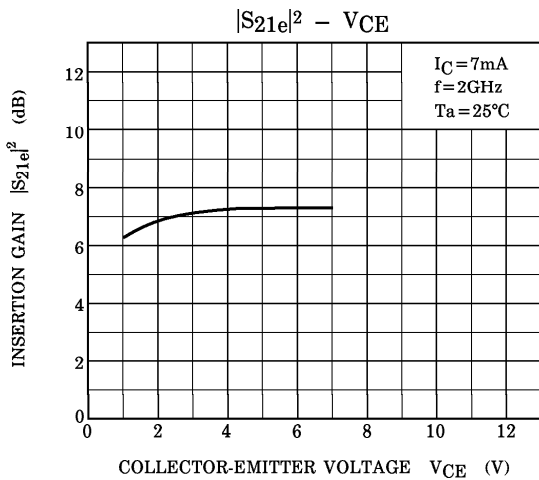

S-Parameter  $Z_0 = 50\Omega$ ,  $T_a = 25^\circ\text{C}$   
 $V_{CE} = 6\text{V}$ ,  $I_C = 3\text{mA}$

frequency (MHz)	S11		S21		S12		S22	
	Mag.	Ang.	Mag.	Ang.	Mag.	Ang.	Mag.	Ang.
200	0.817	-25.8	7.113	150.2	0.044	71.4	0.898	-18.6
400	0.647	-46.3	6.028	129.5	0.073	61.8	0.746	-28.7
600	0.477	-61.4	5.061	113.9	0.092	57.2	0.636	-33.4
800	0.356	-71.3	4.197	102.8	0.108	55.7	0.565	-35.4
1000	0.265	-78.9	3.583	93.9	0.123	55.3	0.518	-36.8
1200	0.194	-85.6	3.135	86.7	0.137	55.7	0.486	-37.5
1400	0.136	-90.5	2.778	80.2	0.153	55.8	0.467	-38.8
1600	0.093	-97.7	2.490	74.4	0.169	55.3	0.449	-40.4
1800	0.058	-109.0	2.260	69.6	0.183	54.8	0.433	-42.6
2000	0.028	-134.7	2.089	65.2	0.199	55.2	0.418	-43.9

$V_{CE} = 6\text{V}$ ,  $I_C = 7\text{mA}$

frequency (MHz)	S11		S21		S12		S22	
	Mag.	Ang.	Mag.	Ang.	Mag.	Ang.	Mag.	Ang.
200	0.630	-39.7	12.332	138.1	0.037	68.5	0.783	-25.6
400	0.392	-64.1	8.847	114.7	0.059	64.3	0.586	-31.8
600	0.248	-78.3	6.514	101.4	0.077	64.1	0.495	-32.0
800	0.161	-87.5	5.094	92.6	0.096	64.7	0.449	-31.2
1000	0.105	-95.3	4.213	85.9	0.114	64.9	0.423	-30.5
1200	0.060	-106.3	3.589	80.3	0.133	65.0	0.412	-30.8
1400	0.028	-121.7	3.139	74.9	0.154	64.0	0.406	-32.1
1600	0.021	-158.4	2.786	70.1	0.173	62.5	0.398	-34.0
1800	0.035	171.6	2.498	66.0	0.190	61.2	0.387	-36.7
2000	0.054	144.0	2.300	62.3	0.210	60.7	0.377	-38.4

**S<sub>11e</sub>**  
 V<sub>CE</sub> = 6V  
 I<sub>C</sub> = 3mA  
 T<sub>a</sub> = 25°C  
 (UNIT : Ω)

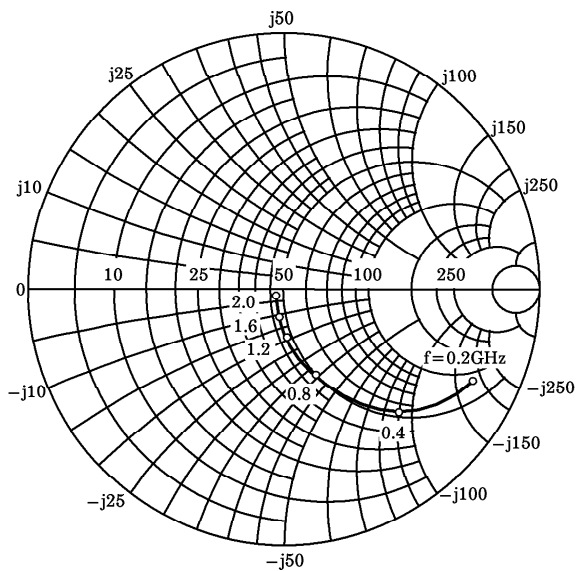

**S<sub>21e</sub>**  
 V<sub>CE</sub> = 6V  
 I<sub>C</sub> = 3mA  
 T<sub>a</sub> = 25°C

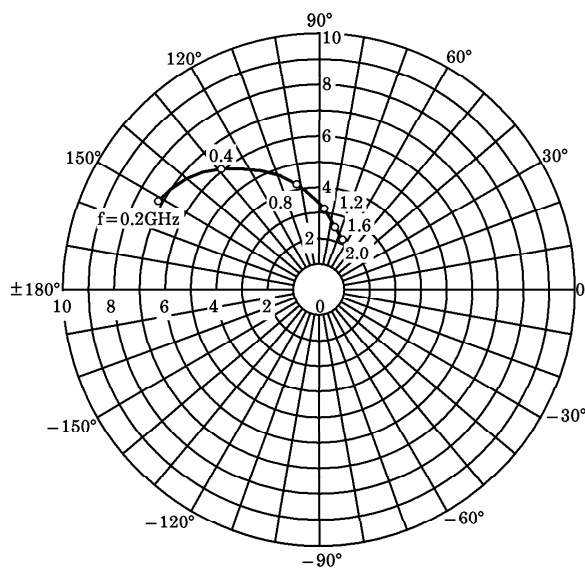

**S<sub>12e</sub>**  
 V<sub>CE</sub> = 6V  
 I<sub>C</sub> = 3mA  
 T<sub>a</sub> = 25°C

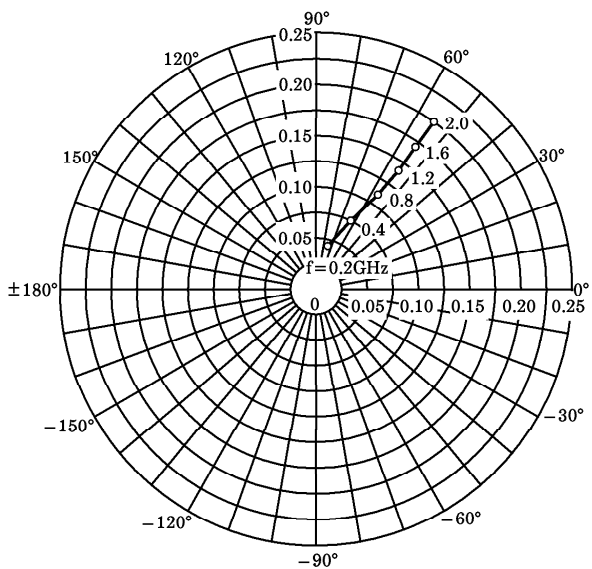

**S<sub>22e</sub>**  
 V<sub>CE</sub> = 6V  
 I<sub>C</sub> = 3mA  
 T<sub>a</sub> = 25°C  
 (UNIT : Ω)

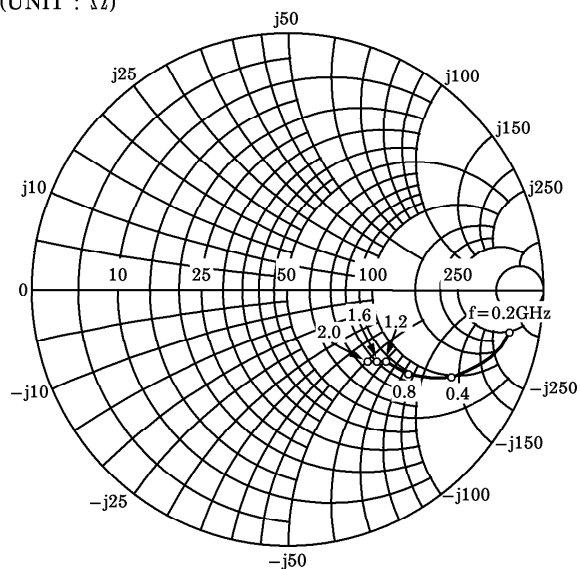

**S<sub>11e</sub>**  
 V<sub>CE</sub>=6V  
 I<sub>C</sub>=7mA  
 T<sub>a</sub>=25°C  
 (UNIT : Ω)

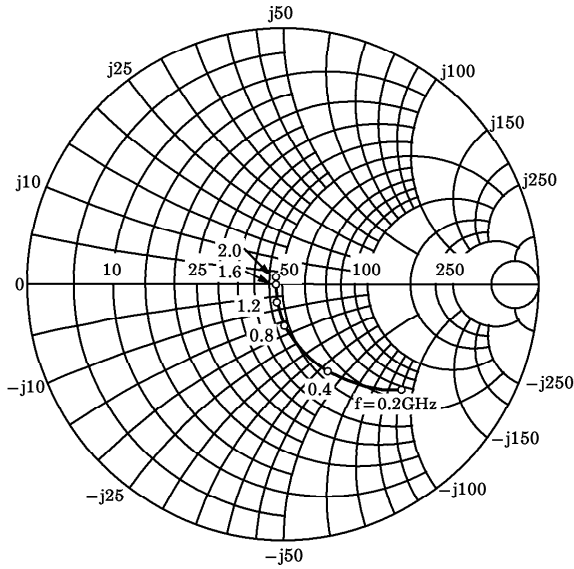

**S<sub>21e</sub>**  
 V<sub>CE</sub>=6V  
 I<sub>C</sub>=7mA  
 T<sub>a</sub>=25°C

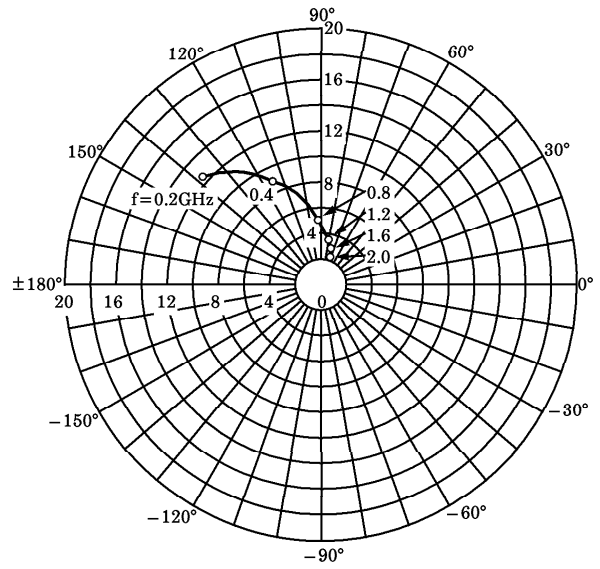

**S<sub>12e</sub>**  
 V<sub>CE</sub>=6V  
 I<sub>C</sub>=7mA  
 T<sub>a</sub>=25°C

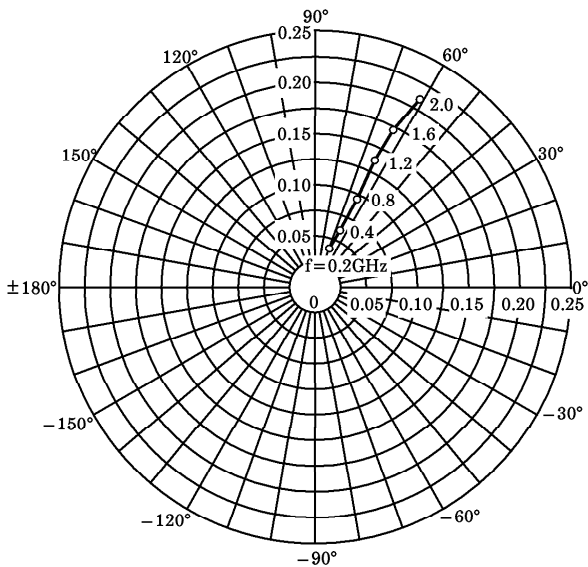

**S<sub>22e</sub>**  
 V<sub>CE</sub>=6V  
 I<sub>C</sub>=7mA  
 T<sub>a</sub>=25°C  
 (UNIT : Ω)

