

TOSHIBA TRANSISTOR SILICON NPN EPITAXIAL PLANAR TYPE

2SC5064

VHF~UHF BAND LOW NOISE AMPLIFIER APPLICATIONS

Unit in mm

- Low Noise Figure, High Gain.
- $NF=1.1dB, |S_{21e}|^2=12dB (f=1GHz)$

MAXIMUM RATINGS (Ta = 25°C)

CHARACTERISTIC	SYMBOL	RATING	UNIT
Collector-Base Voltage	V _{CBO}	20	V
Collector-Emitter Voltage	V _{CEO}	12	V
Emitter-Base Voltage	V _{EBO}	3	V
Base Current	I _B	15	mA
Collector Current	I _C	30	mA
Collector Power Dissipation	P _C	150	mW
Junction Temperature	T _j	125	°C
Storage Temperature Range	T _{stg}	-55~125	°C

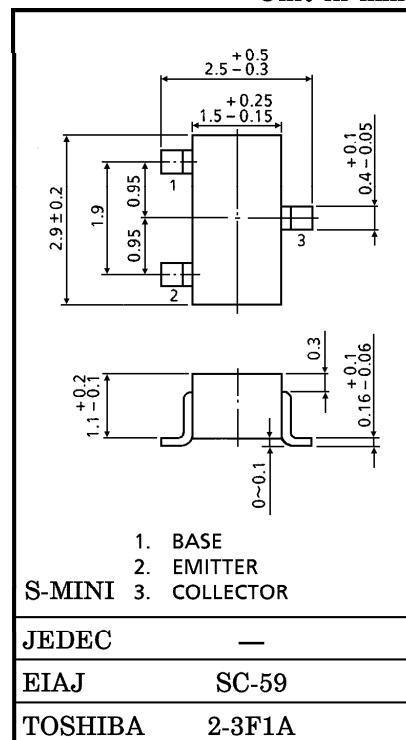

Weight : 0.012g

MARKING

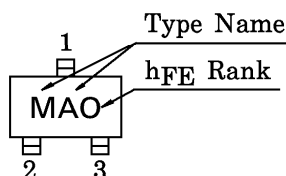

MICROWAVE CHARACTERISTICS (Ta = 25°C)

CHARACTERISTIC	SYMBOL	TEST CONDITION	MIN.	TYP.	MAX.	UNIT
Transition Frequency	f _T	V _{CE} =5V, I _C =10mA	5	7	—	GHz
Insertion Gain	S _{21e} ² (1)	V _{CE} =5V, I _C =10mA, f=500MHz	—	17	—	dB
	S _{21e} ² (2)	V _{CE} =5V, I _C =10mA, f=1GHz	8.5	12	—	
Noise Figure	NF (1)	V _{CE} =5V, I _C =3mA, f=500MHz	—	1	—	dB
	NF (2)	V _{CE} =5V, I _C =3mA, f=1GHz	—	1.1	2.0	

ELECTRICAL CHARACTERISTICS (Ta = 25°C)

CHARACTERISTIC	SYMBOL	TEST CONDITION	MIN.	TYP.	MAX.	UNIT
Collector Cut-off Current	I _{CBO}	V _{CB} =10V, I _E =0	—	—	1	μA
Emitter Cut-off Current	I _{EBO}	V _{EB} =1V, I _C =0	—	—	1	μA
DC Current Gain	h _{FE} (Note 1)	V _{CE} =5V, I _C =10mA	80	—	240	—
Output Capacitance	C _{ob}	V _{CB} =5V, I _E =0, f=1MHz	—	0.7	—	pF
Reverse Transfer Capacitance	C _{re}	(Note 2)	—	0.45	0.9	pF

(Note 1) h_{FE} Classification O : 80~160, Y : 120~240

(Note 2) C_{re} is measured by 3 terminal method with capacitance bridge.

961001EAA2

- TOSHIBA is continually working to improve the quality and the reliability of its products. Nevertheless, semiconductor devices in general can malfunction or fail due to their inherent electrical sensitivity and vulnerability to physical stress. It is the responsibility of the buyer, when utilizing TOSHIBA products, to observe standards of safety, and to avoid situations in which a malfunction or failure of a TOSHIBA product could cause loss of human life, bodily injury or damage to property. In developing your designs, please ensure that TOSHIBA products are used within specified operating ranges as set forth in the most recent products specifications. Also, please keep in mind the precautions and conditions set forth in the TOSHIBA Semiconductor Reliability Handbook.
- The information contained herein is presented only as a guide for the applications of our products. No responsibility is assumed by TOSHIBA CORPORATION for any infringements of intellectual property or other rights of the third parties which may result from its use. No license is granted by implication or otherwise under any intellectual property or other rights of TOSHIBA CORPORATION or others.
- The information contained herein is subject to change without notice.

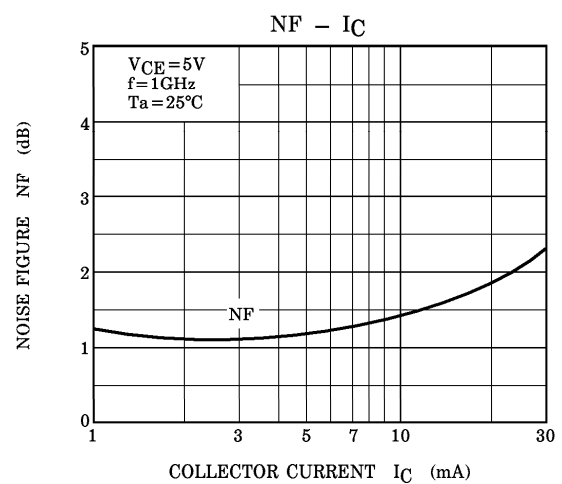
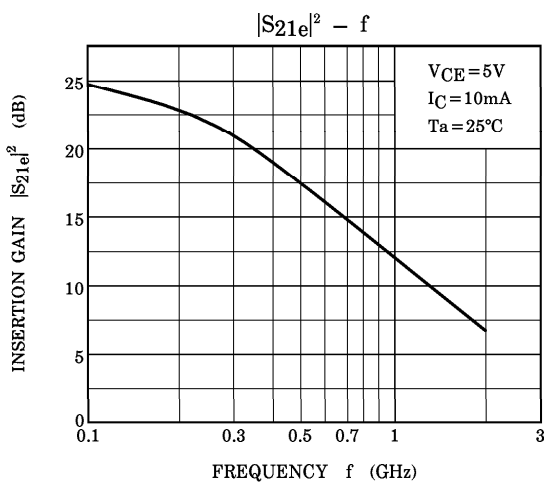
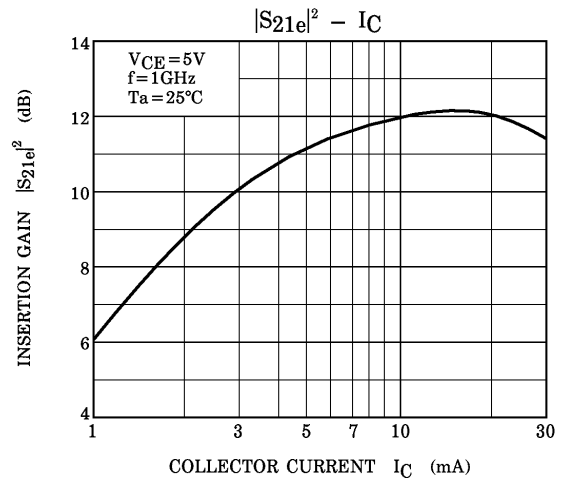
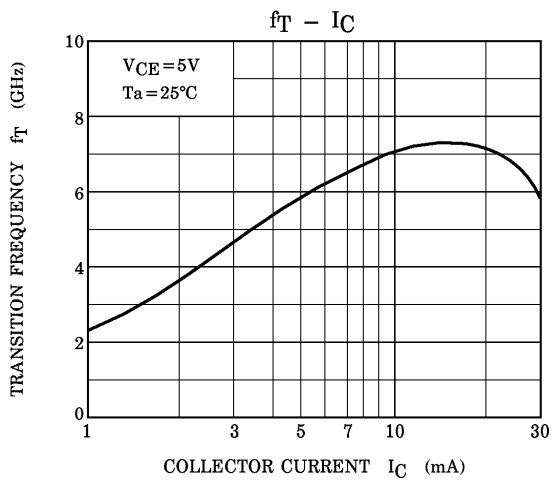
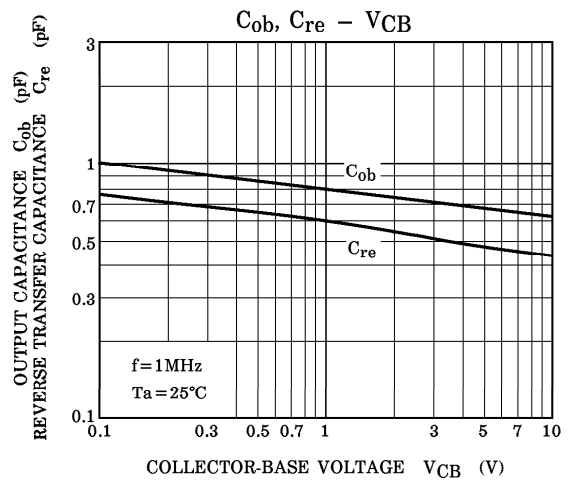
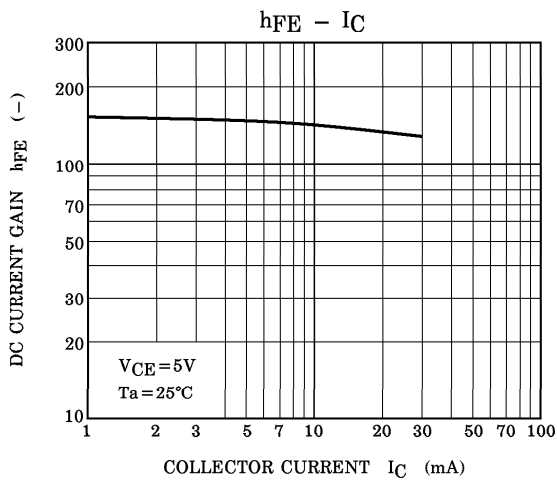

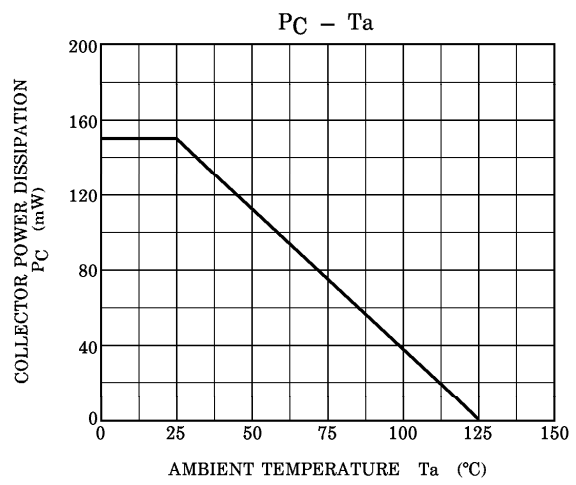
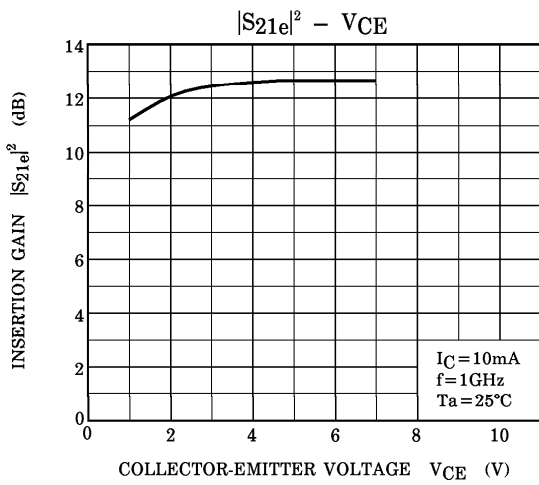

S-Parameter $Z_0 = 50\Omega$, $T_a = 25^\circ\text{C}$
 $V_{CE} = 5\text{V}$, $I_C = 5\text{mA}$

frequency (MHz)	S11		S21		S12		S22	
	Mag.	Ang.	Mag.	Ang.	Mag.	Ang.	Mag.	Ang.
200	0.753	-43.7	10.247	140.6	0.040	65.6	0.827	-22.6
400	0.531	-75.1	7.684	117.1	0.060	57.1	0.648	-30.3
600	0.384	-96.4	5.815	103.0	0.074	56.1	0.551	-32.0
800	0.305	-112.6	4.523	93.6	0.086	57.0	0.500	-32.3
1000	0.255	-126.5	3.788	86.3	0.099	58.9	0.472	-32.4
1200	0.224	-138.4	3.244	80.7	0.112	60.2	0.455	-32.2
1400	0.203	-150.1	2.833	75.4	0.127	60.3	0.442	-32.6
1600	0.187	-159.4	2.529	70.6	0.139	60.0	0.434	-33.0
1800	0.174	-166.5	2.283	66.7	0.150	60.3	0.429	-32.6
2000	0.176	-171.2	2.107	63.0	0.164	59.2	0.428	-32.2

$V_{CE} = 5\text{V}$, $I_C = 10\text{mA}$

frequency (MHz)	S11		S21		S12		S22	
	Mag.	Ang.	Mag.	Ang.	Mag.	Ang.	Mag.	Ang.
200	0.591	-58.0	14.955	129.6	0.034	64.3	0.714	-27.5
400	0.367	-90.3	9.581	107.5	0.052	61.9	0.534	-30.8
600	0.260	-110.7	6.781	96.1	0.067	63.9	0.462	-30.1
800	0.209	-126.9	5.207	88.6	0.083	65.2	0.428	-29.2
1000	0.178	-141.8	4.269	82.5	0.100	66.4	0.412	-28.6
1200	0.160	-153.7	3.618	77.7	0.117	66.7	0.403	-28.3
1400	0.150	-166.3	3.152	72.7	0.135	65.4	0.398	-28.8
1600	0.141	-175.2	2.801	68.7	0.149	64.0	0.393	-29.4
1800	0.130	178.2	2.521	65.0	0.163	63.4	0.392	-29.0
2000	0.133	174.0	2.314	61.7	0.179	61.3	0.395	-28.6

S_{11e}
 V_{CE}=5V
 I_C=5mA
 T_a=25°C
 (UNIT : Ω)

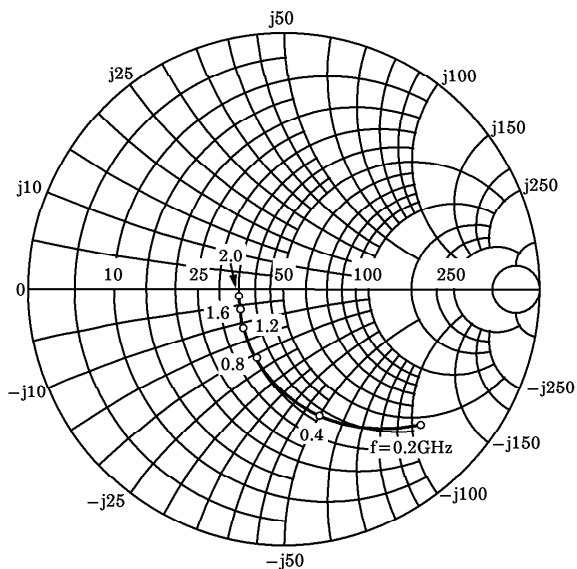

S_{21e}
 V_{CE}=5V
 I_C=5mA
 T_a=25°C

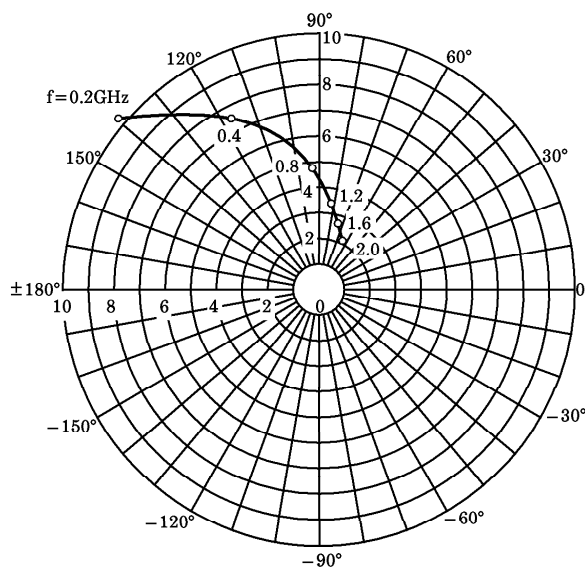

S_{12e}
 V_{CE}=5V
 I_C=5mA
 T_a=25°C

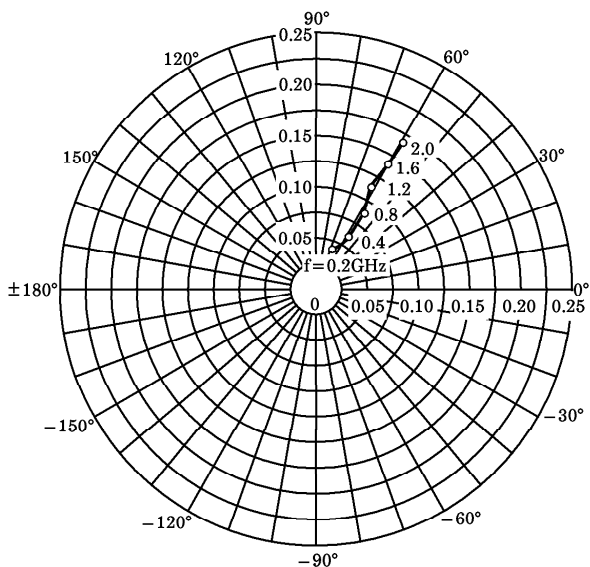

S_{22e}
 V_{CE}=5V
 I_C=5mA
 T_a=25°C
 (UNIT : Ω)

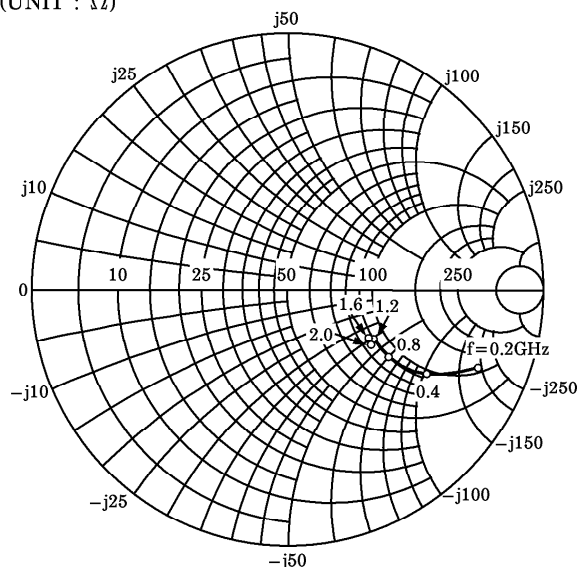

S_{11e}
 V_{CE}=5V
 I_C=10mA
 T_a=25°C
 (UNIT : Ω)

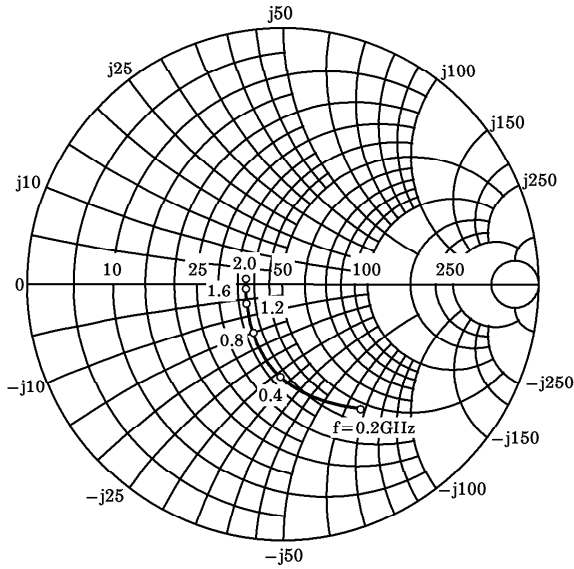

S_{21e}
 V_{CE}=5V
 I_C=10mA
 T_a=25°C

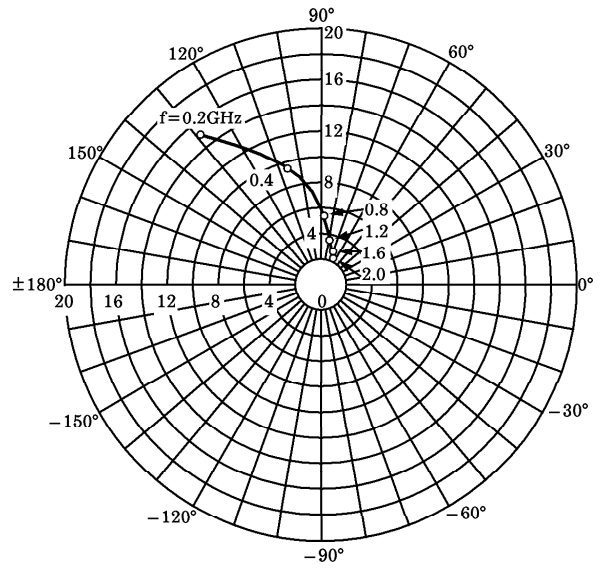

S_{12e}
 V_{CE}=5V
 I_C=10mA
 T_a=25°C

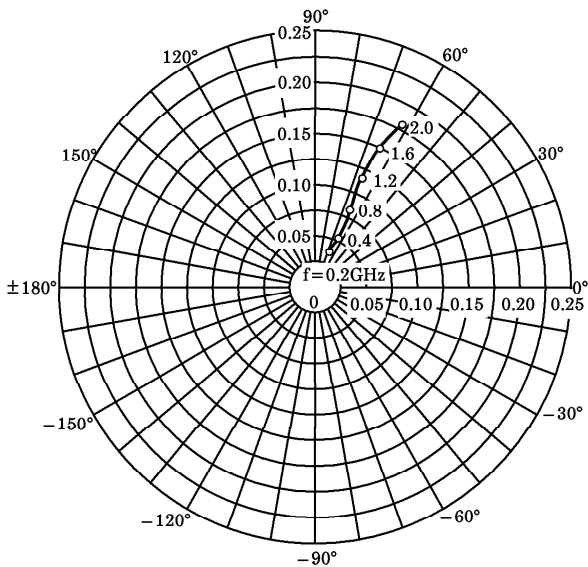

S_{22e}
 V_{CE}=5V
 I_C=10mA
 T_a=25°C
 (UNIT : Ω)

