

SANYO

No.3706A

2SC4637

NPN Triple Diffused Planar Silicon Transistor
 High-Voltage Amp,
 High-Voltage Switching Applications

Features

- High breakdown voltage (V_{CEO} min = 1800V).
- Small Cob (typical Cob = 1.8pF).
- Full-isolation package.
- High reliability (Adoption of HVP process).

Absolute Maximum Ratings at $T_a = 25^\circ\text{C}$

			unit
Collector-to-Base Voltage	V_{CBO}	2000	V
Collector-to-Emitter Voltage	V_{CEO}	1800	V
Emitter-to-Base Voltage	V_{EBO}	5	V
Collector Current	I_C	15	mA
Collector Current (Pulse)	I_{CP}	50	mA
Collector Dissipation	P_C	2	W
Junction Temperature	T_j	150	$^\circ\text{C}$
Storage Temperature	T_{stg}	-55 to +150	$^\circ\text{C}$

Electrical Characteristics at $T_a = 25^\circ\text{C}$

			min	typ	max	unit
Collector Cutoff Current	I_{CBO}	$V_{CB} = 1800\text{V}, I_E = 0$			1	μA
Emitter Cutoff Current	I_{EBO}	$V_{EB} = 4\text{V}, I_C = 0$			1	μA
DC Current Gain	h_{FE}	$V_{CE} = 5\text{V}, I_C = 300\mu\text{A}$	10		60	
Gain-Bandwidth Product	f_T	$V_{CE} = 10\text{V}, I_C = 300\mu\text{A}$		6		MHz
C-E Saturation Voltage	$V_{CE(sat)}$	$I_C = 600\mu\text{A}, I_B = 120\mu\text{A}$			5	V
B-E Saturation Voltage	$V_{BE(sat)}$	$I_C = 600\mu\text{A}, I_B = 120\mu\text{A}$			2	V
C-B Breakdown Voltage	$V_{(BR)CBO}$	$I_C = 100\mu\text{A}, I_E = 0$	2000			V
C-E Breakdown Voltage	$V_{(BR)CEO}$	$I_C = 100\mu\text{A}, R_{BE} = \infty$	1800			V
E-B Breakdown Voltage	$V_{(BR)EBO}$	$I_E = 10\mu\text{A}, I_C = 0$	5			V
Output Capacitance	Cob	$V_{CB} = 100\text{V}, f = 1\text{MHz}$		1.8		pF
Thermal Resistance	R_{thj-c}	Junction - case			8.3	$^\circ\text{C/W}$

Package Dimensions 2079B

(unit : mm)

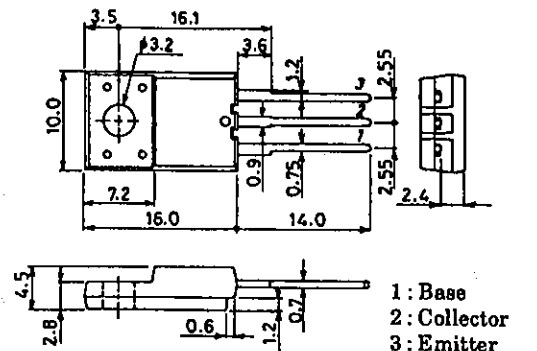

SANYO : TO-220FI(LS)

SANYO Electric Co., Ltd. Semiconductor Business Headquarters

TOKYO OFFICE Tokyo Bldg., 1-10, 1 Chome, Ueno, Taito-ku, TOKYO, 110 JAPAN

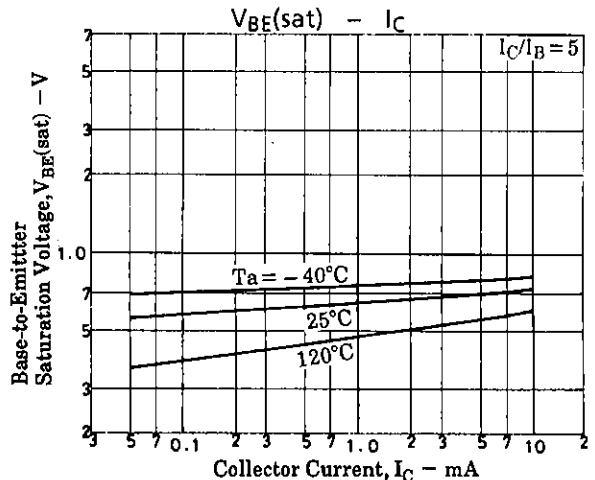
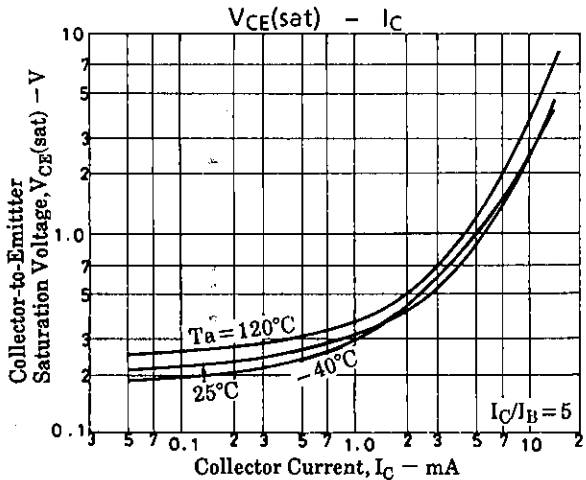
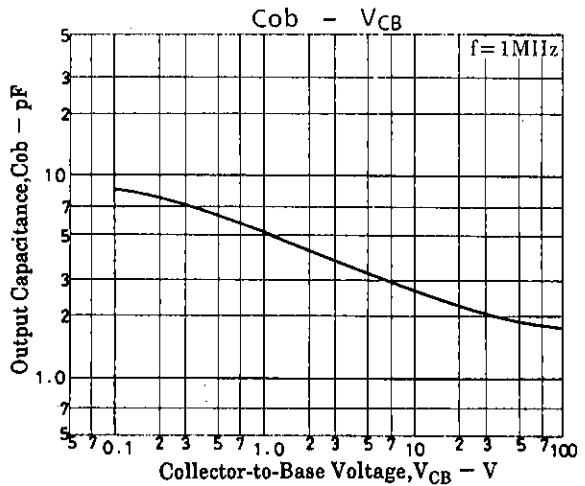
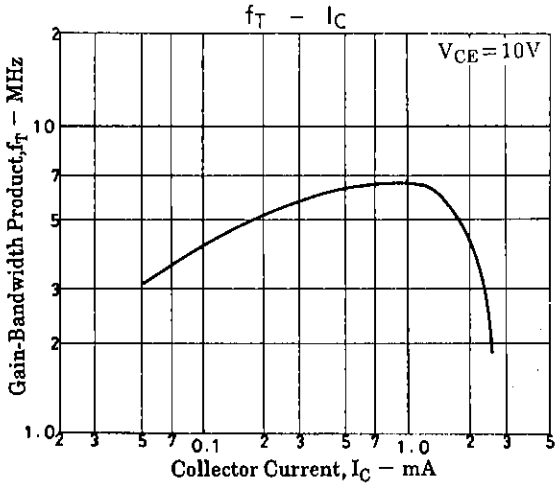
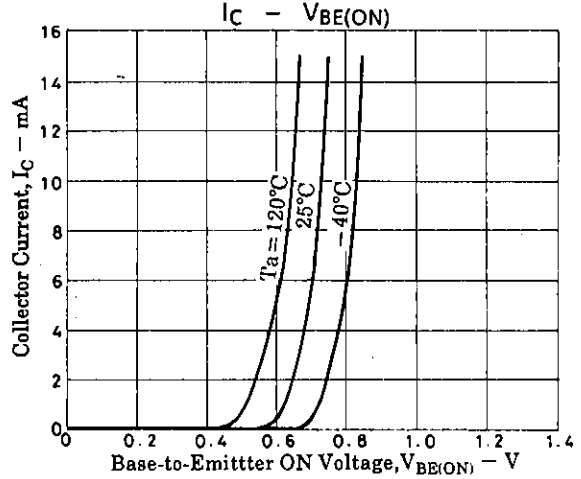
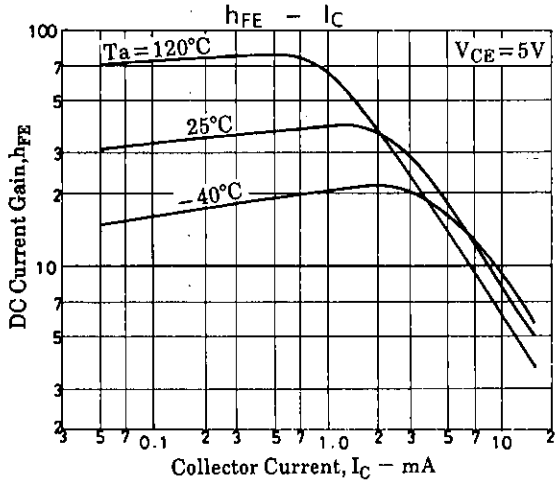
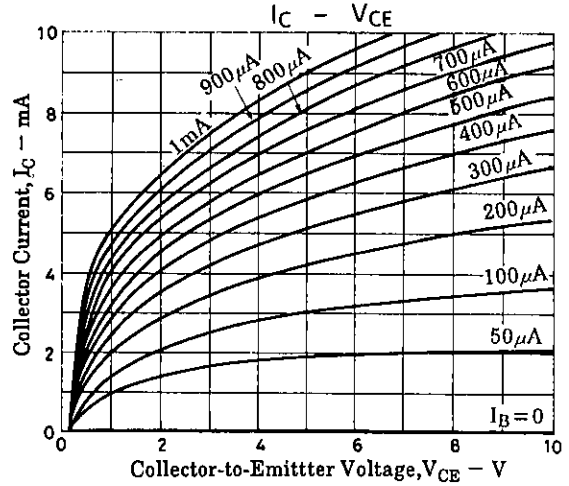
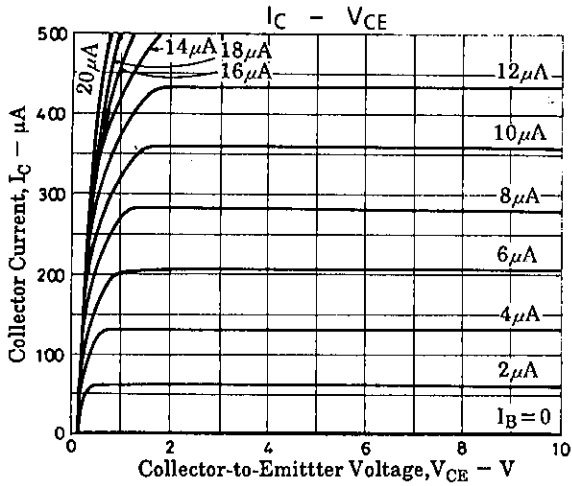

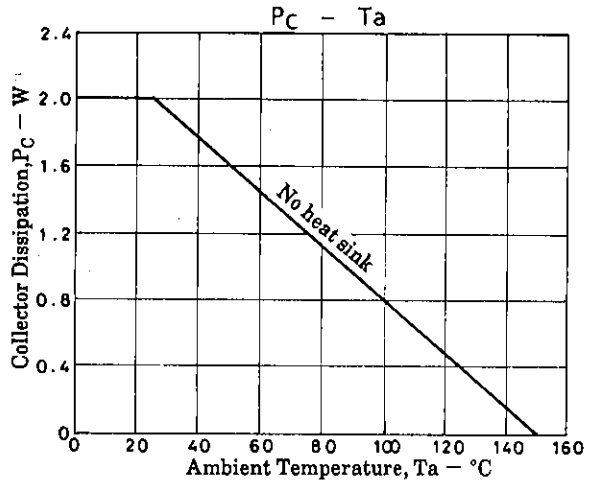
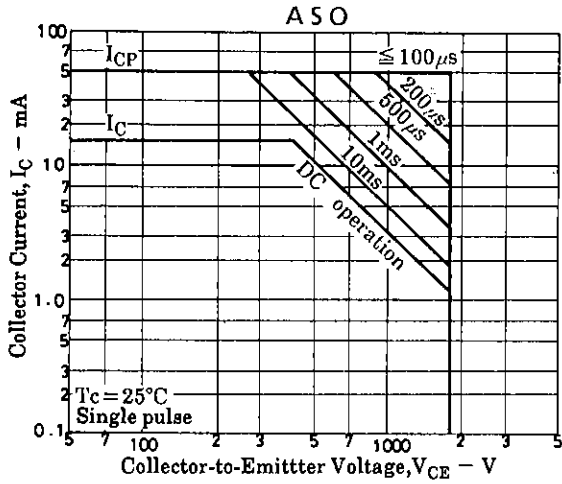

- No products described or contained herein are intended for use in surgical implants, life-support systems, aerospace equipment, nuclear power control systems, vehicles, disaster/crime-prevention equipment and the like, the failure of which may directly or indirectly cause injury, death or property loss.
- Anyone purchasing any products described or contained herein for an above-mentioned use shall:
 - ① Accept full responsibility and indemnify and defend SANYO ELECTRIC CO., LTD., its affiliates, subsidiaries and distributors and all their officers and employees, jointly and severally, against any and all claims and litigation and all damages, cost and expenses associated with such use;
 - ② Not impose any responsibility for any fault or negligence which may be cited in any such claim or litigation on SANYO ELECTRIC CO., LTD., its affiliates, subsidiaries and distributors or any of their officers and employees jointly or severally.
- Information (including circuit diagrams and circuit parameters) herein is for example only; it is not guaranteed for volume production. SANYO believes information herein is accurate and reliable, but no guarantees are made or implied regarding its use or any infringements of intellectual property rights or other rights of third parties.

This catalog provides information as of August, 1996. Specifications and information herein are subject to change without notice.