

# 2SC4584

## (TP6W80HFX)

### 6A NPN

### OUTLINE DIMENSIONS

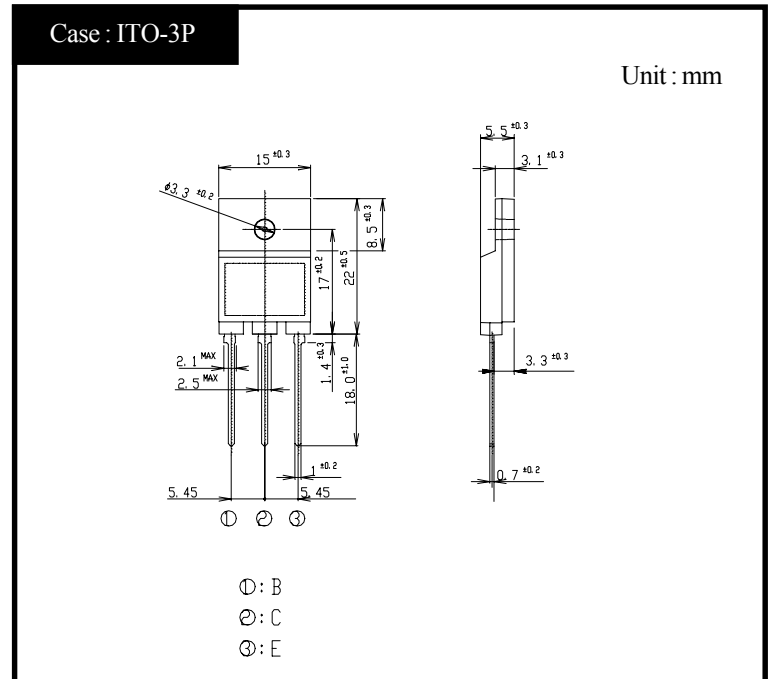

### RATINGS

#### ● Absolute Maximum Ratings

Item	Symbol	Conditions	Ratings	Unit
Storage Temperature	$T_{stg}$		-55~150	°C
Junction Temperature	$T_j$		150	°C
Collector to Base Voltage	$V_{CBO}$		1200	V
Collector to Emitter Voltage	$V_{CEO}$		800	V
Emitter to Base Voltage	$V_{EBO}$		7	V
Collector Current DC	$I_C$		6	A
Collector Current Peak	$I_{CP}$		12	
Base Current DC	$I_B$		3	A
Base Current Peak	$I_{BP}$		6	
Total Transistor Dissipation	$P_T$	$T_c = 25^\circ\text{C}$	65	W
Dielectric Strength	$V_{dis}$	Terminals to case, AC 1 minute	2	kV
Mounting Torque	TOR	(Recommended torque : 0.5N·m)	0.8	N·m

#### ● Electrical Characteristics ( $T_c=25^\circ\text{C}$ )

Item	Symbol	Conditions	Ratings	Unit
Collector to Emitter Sustaining Voltage	$V_{CEO(sus)}$	$I_C = 0.2\text{A}$	Min 800	V
Collector Cutoff Current	$I_{CBO}$	At rated Voltage	Max 0.1	mA
	$I_{CEO}$		Max 0.1	
Emitter Cutoff Current	$I_{EBO}$	At rated Voltage	Max 0.1	mA
DC Current Gain	$h_{FE}$	$V_{CE} = 5\text{V}, I_C = 3\text{A}$	Min 8	
	$h_{FEL}$	$V_{CE} = 5\text{V}, I_C = 1\text{mA}$	Min 7	
Collector to Emitter Saturation Voltage	$V_{CE(sat)}$	$I_C = 3\text{A}$	Max 1.0	V
Base to Emitter Saturation Voltage	$V_{BE(sat)}$	$I_B = 0.6\text{A}$	Max 1.5	V
Thermal Resistance	$\theta_{jc}$	Junction to case	Max 1.92	°C/W
Transition Frequency	$f_T$	$V_{CE} = 10\text{V}, I_C = 0.6\text{A}$	TYP 8	MHz
Turn on Time	$t_{on}$	$I_C = 3\text{A}$	Max 0.5	$\mu\text{s}$
Storage Time	$t_s$	$I_{B1} = 0.6\text{A}, I_{B2} = 1.2\text{A}$	Max 3.5	
Fall Time	$t_f$	$R_L = 85\ \Omega, V_{BB2} = 4\text{V}$	Max 0.3	

# 2SC4584 $h_{FE} - I_C$

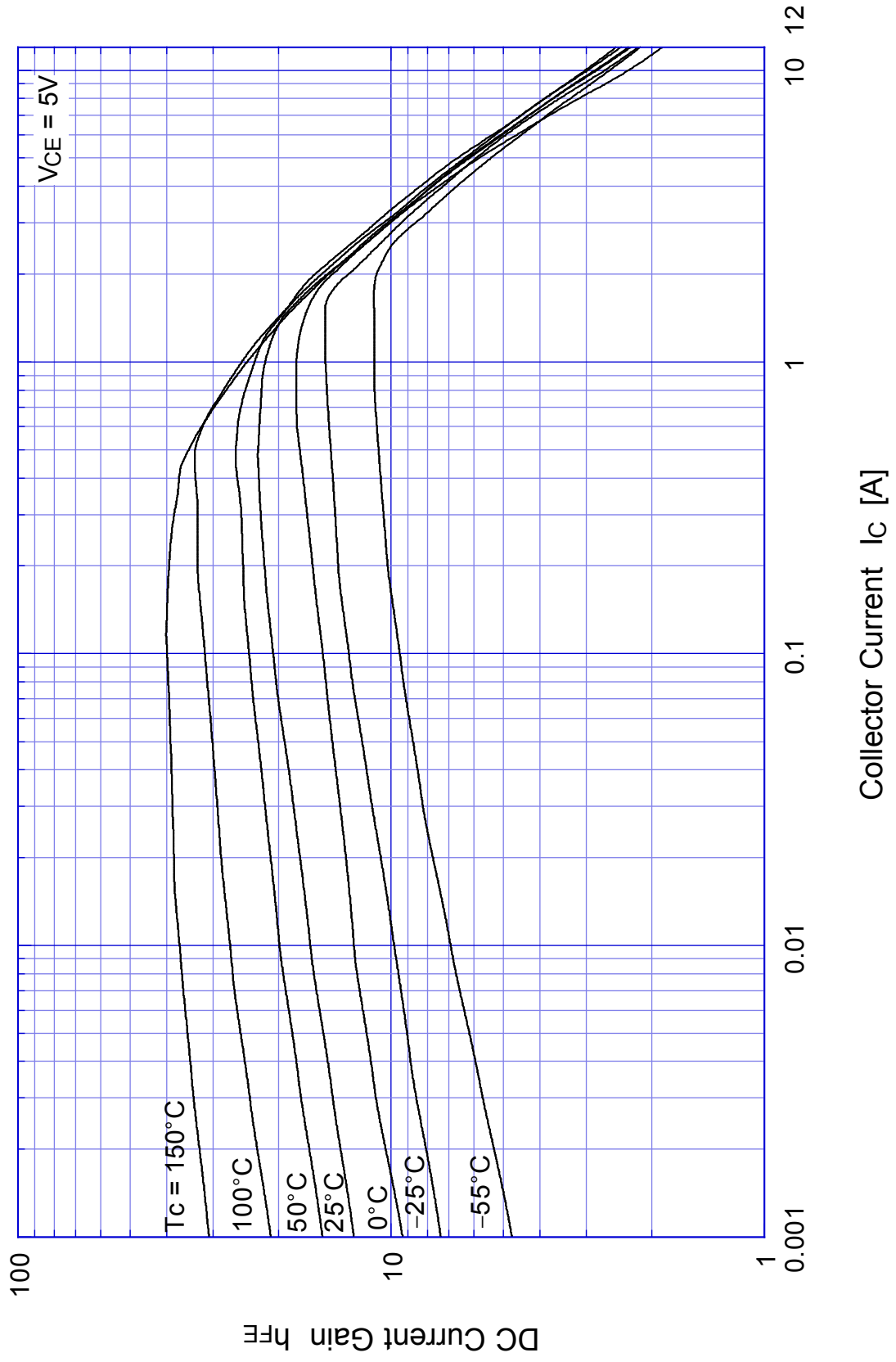

# 2SC4584 Saturation Voltage

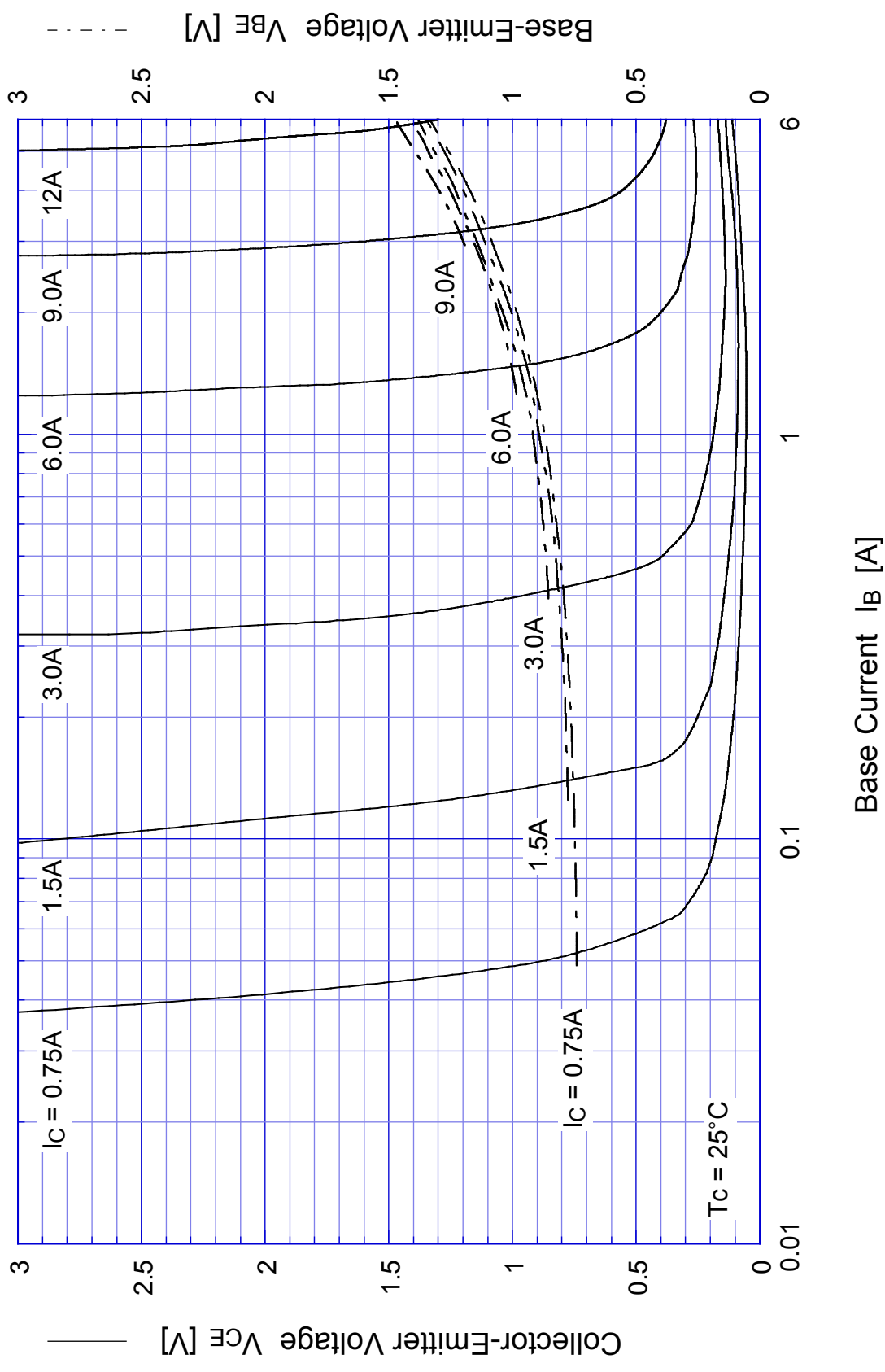

# 2SC4584

## Switching Time - $I_C$

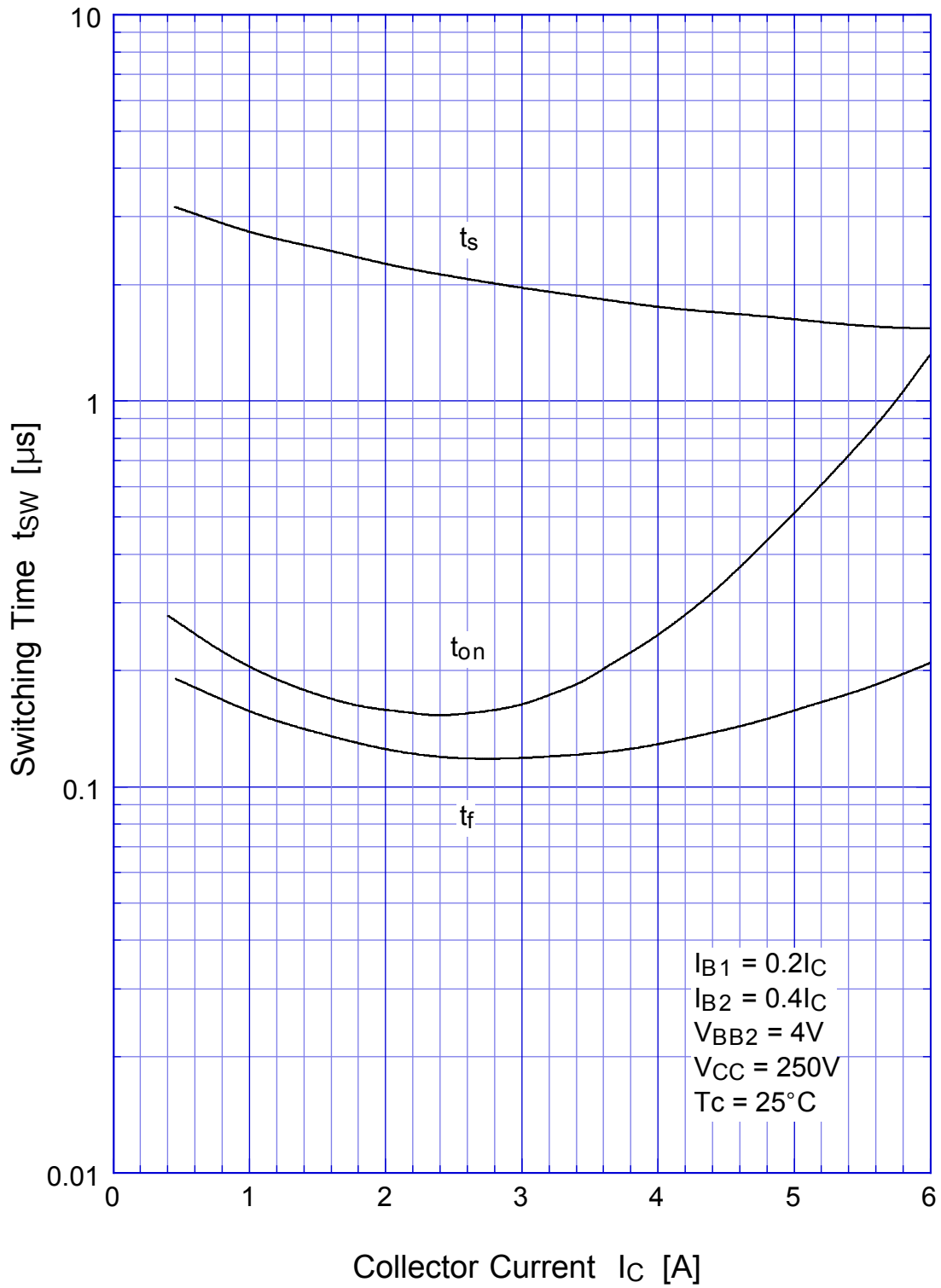

2SC4584 Switching Time -  $V_{CC}$

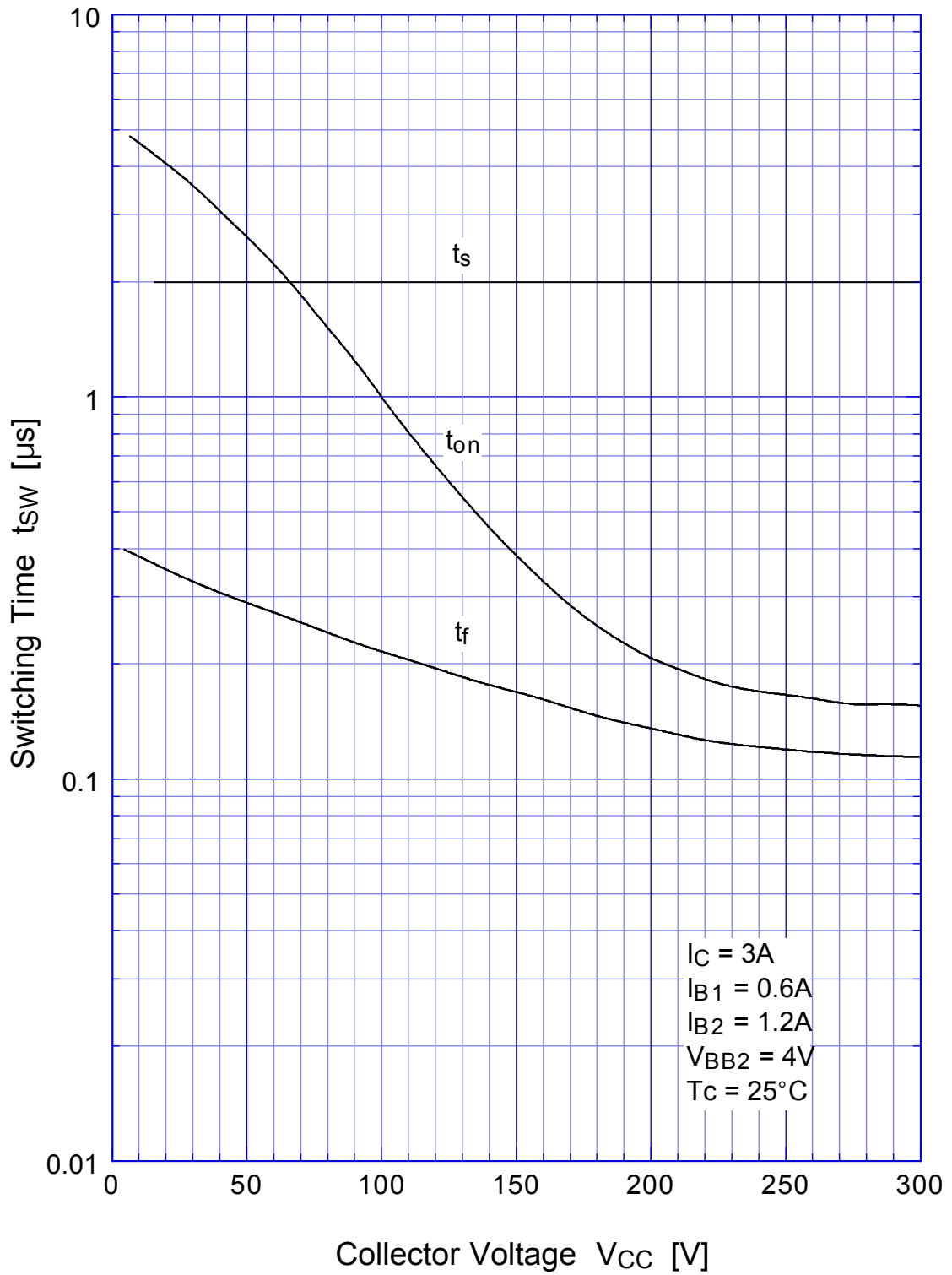

# 2SC4584

## Switching Time - Tc

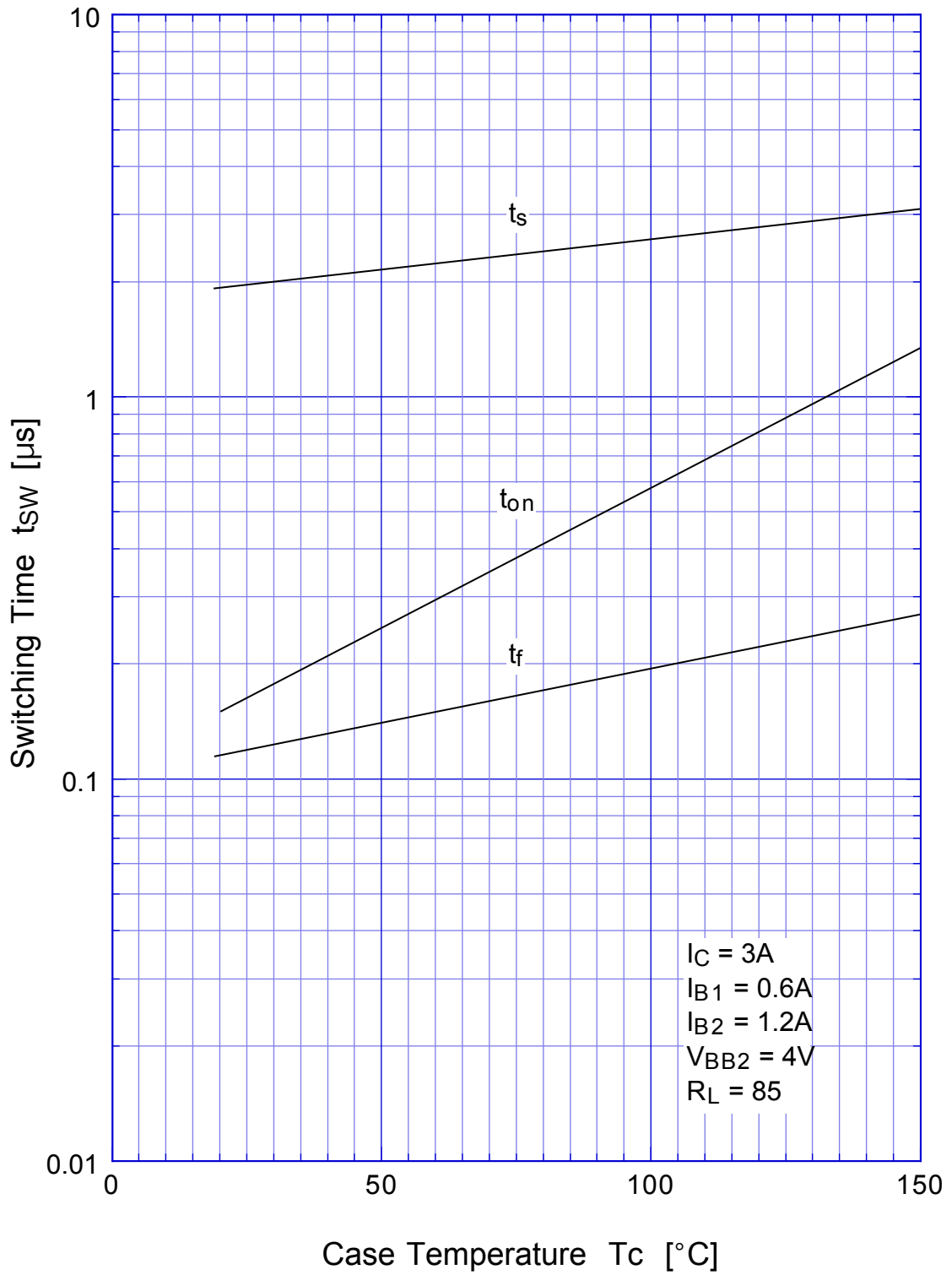

## 2SC4584 Transient Thermal Impedance

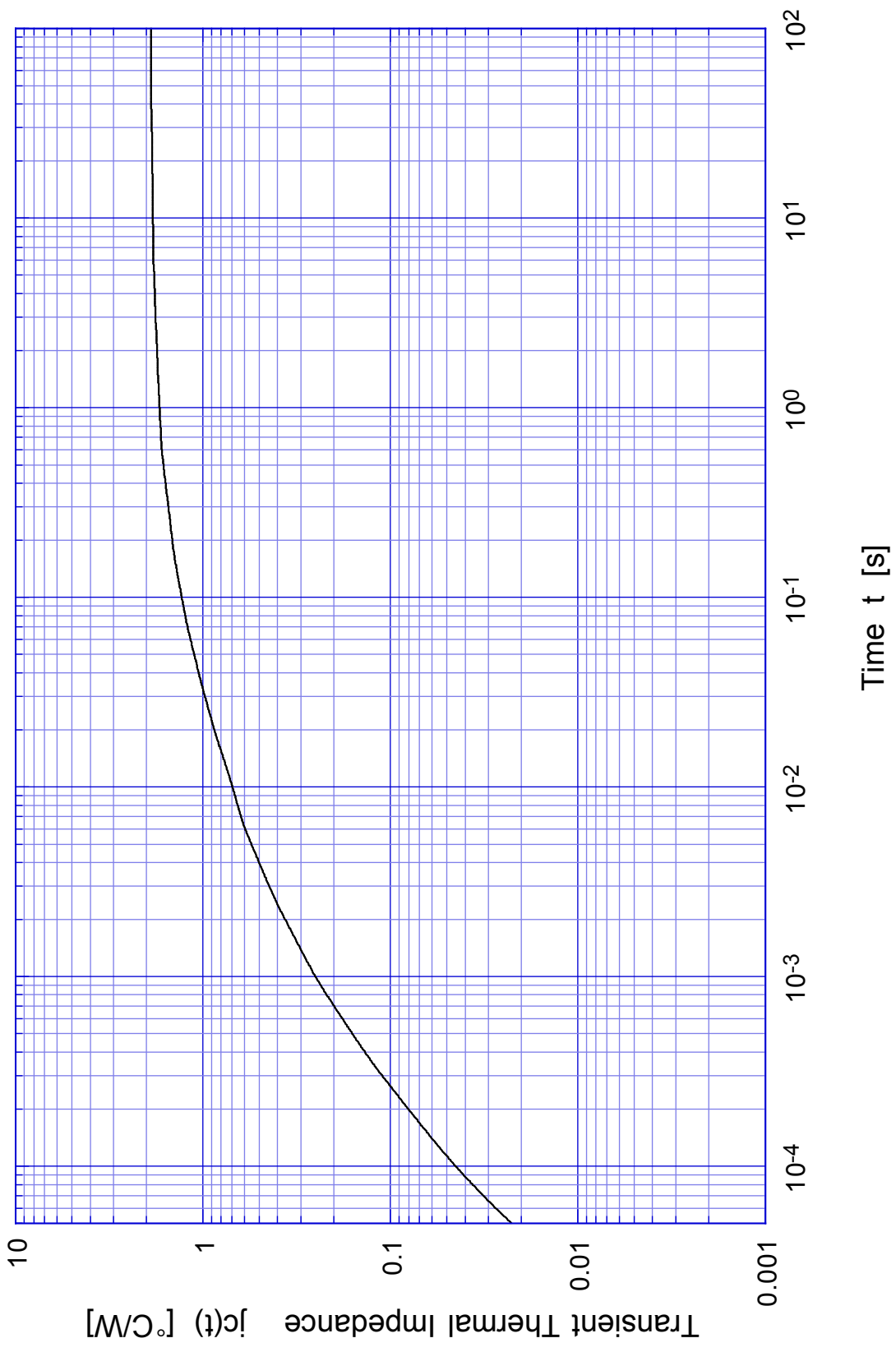

# 2SC4584 Forward Bias SOA

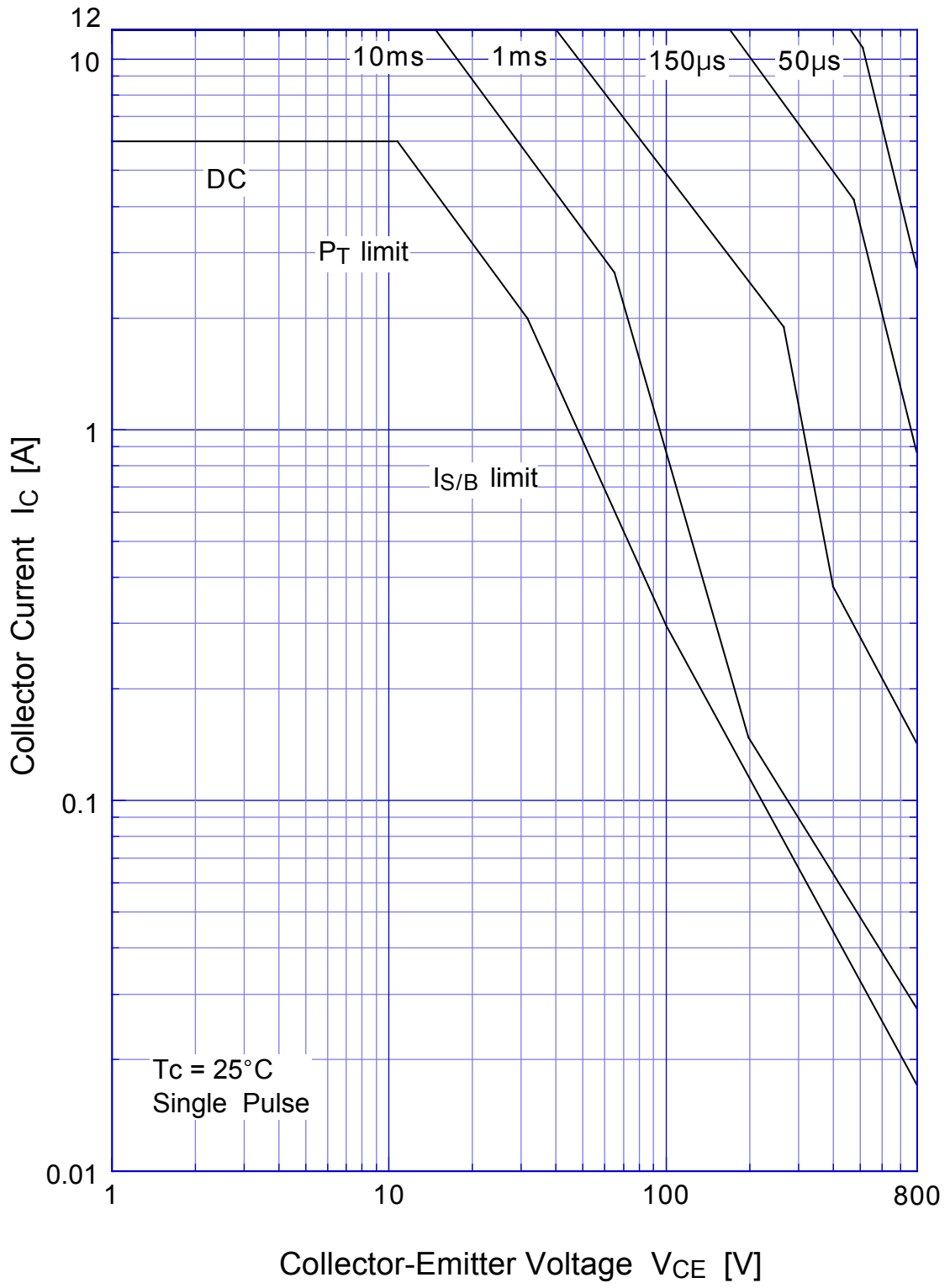



## 2SC4584 Collector Current Derating

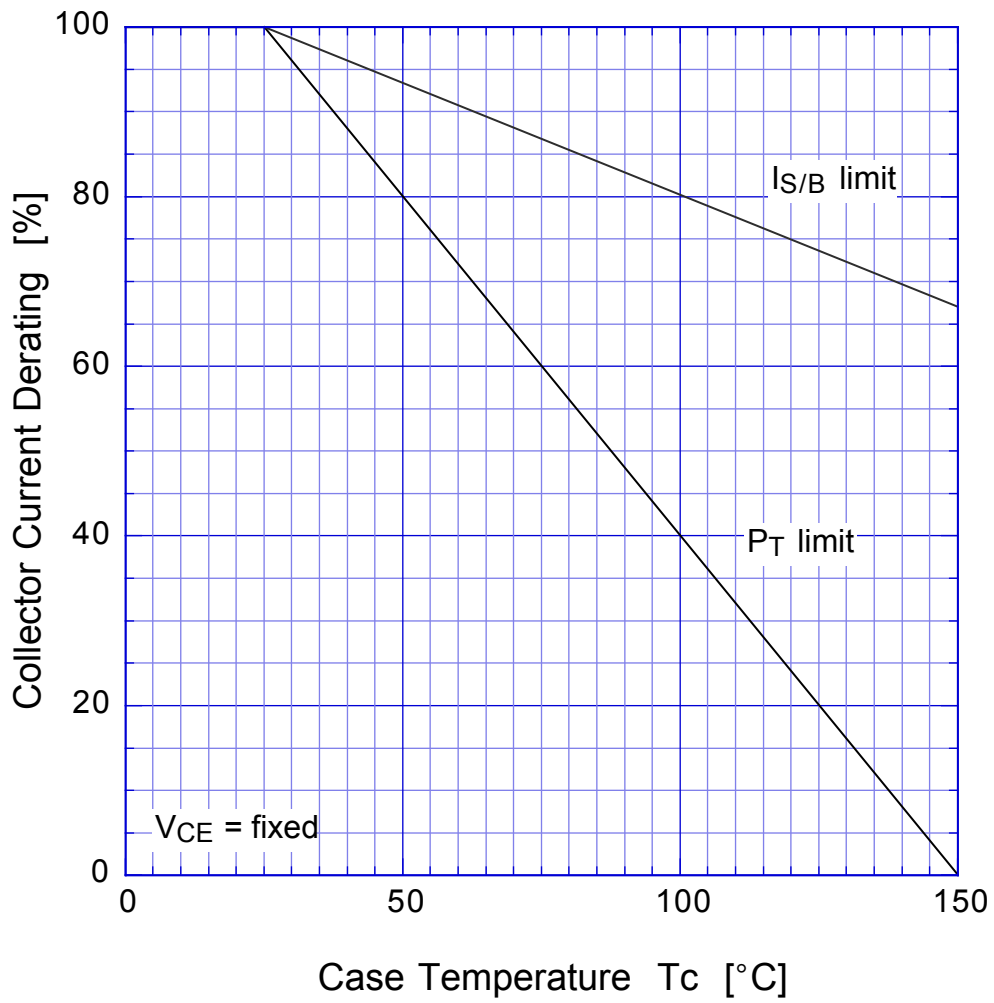

2SC4584

Reverse Bias SOA

