

# 2SC4533

## Silicon NPN triple diffusion planar type

For high breakdown voltage high-speed switching

### Features

- High-speed switching
- High collector to base voltage  $V_{CBO}$
- Wide area of safe operation (ASO)
- Satisfactory linearity of forward current transfer ratio  $h_{FE}$
- Full-pack package which can be installed to the heat sink with one screw

### Absolute Maximum Ratings ( $T_C=25^\circ\text{C}$ )

Parameter	Symbol	Rated	Unit	
Collector to base voltage	$V_{CBO}$	500	V	
Collector to emitter voltage	$V_{CES}$	500	V	
	$V_{CEO}$	400	V	
Emitter to base voltage	$V_{EBO}$	7	V	
Peak collector current	$I_{CP}$	6	A	
Collector current	$I_C$	3	A	
Base current	$I_B$	1.2	A	
Collector power dissipation	$P_C$	$T_C=25^\circ\text{C}$	30	W
		$T_a=25^\circ\text{C}$	2	
Junction temperature	$T_j$	150	$^\circ\text{C}$	
Storage temperature	$T_{stg}$	-55 to +150	$^\circ\text{C}$	

### Electrical Characteristics ( $T_C=25^\circ\text{C}$ )

Parameter	Symbol	Conditions	min	typ	max	Unit
Collector cutoff current	$I_{CBO}$	$V_{CB} = 500\text{V}, I_E = 0$			100	$\mu\text{A}$
Emitter cutoff current	$I_{EBO}$	$V_{EB} = 5\text{V}, I_C = 0$			100	$\mu\text{A}$
Collector to emitter voltage	$V_{CEO}$	$I_C = 10\text{mA}, I_B = 0$	400			V
Forward current transfer ratio	$h_{FE1}$	$V_{CE} = 5\text{V}, I_C = 0.1\text{A}$	10			
	$h_{FE2}$	$V_{CE} = 2\text{V}, I_C = 1.2\text{A}$	8		40	
Collector to emitter saturation voltage	$V_{CE(sat)}$	$I_C = 1.5\text{A}, I_B = 0.3\text{A}$			1.0	V
Base to emitter saturation voltage	$V_{BE(sat)}$	$I_C = 1.5\text{A}, I_B = 0.3\text{A}$			1.5	V
Transition frequency	$f_T$	$V_{CE} = 10\text{V}, I_C = 0.2\text{A}, f = 1\text{MHz}$		10		MHz
Turn-on time	$t_{on}$	$I_C = 1.5\text{A}, I_{B1} = 0.15\text{A}, I_{B2} = -0.3\text{A}, V_{CC} = 200\text{V}$			1.0	$\mu\text{s}$
Storage time	$t_{stg}$				3.0	$\mu\text{s}$
Fall time	$t_f$				0.3	$\mu\text{s}$

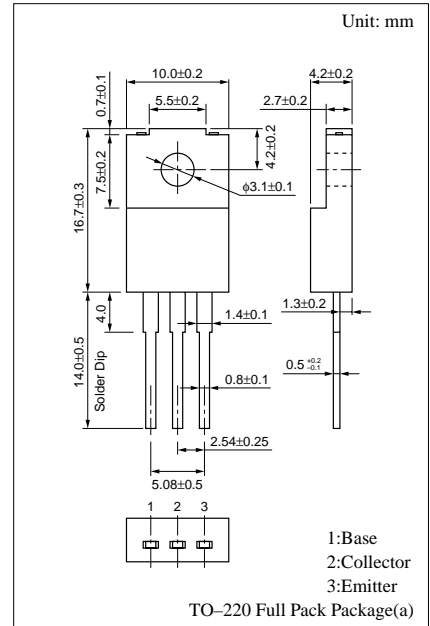

$P_C - T_a$

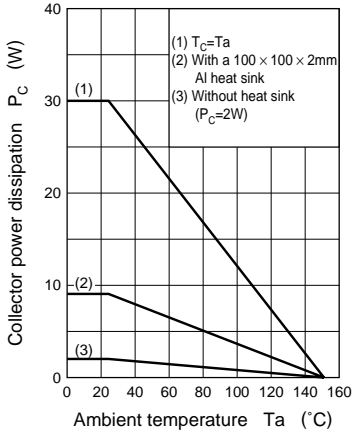

$I_C - V_{CE}$

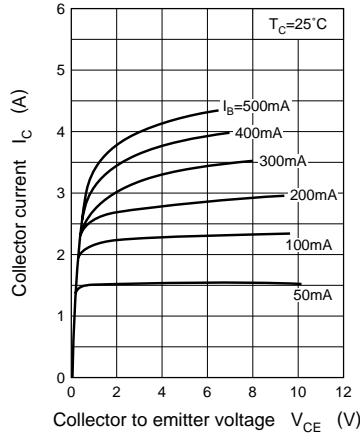

$V_{CE(sat)} - I_C$

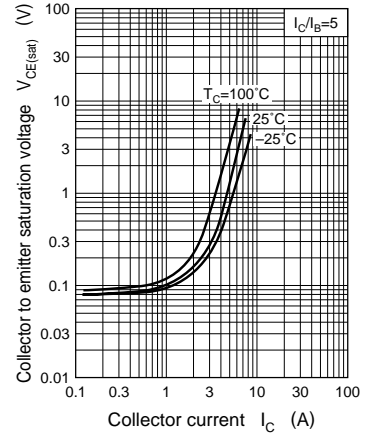

$V_{BE(sat)} - I_C$

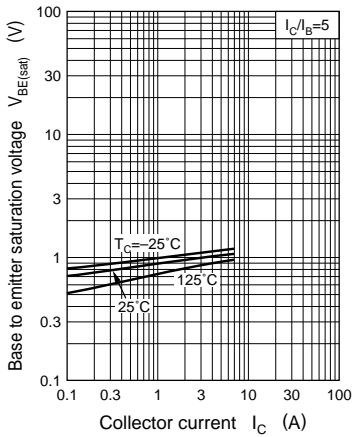

$h_{FE} - I_C$

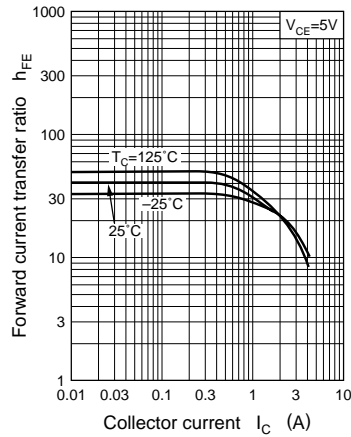

$f_T - I_C$

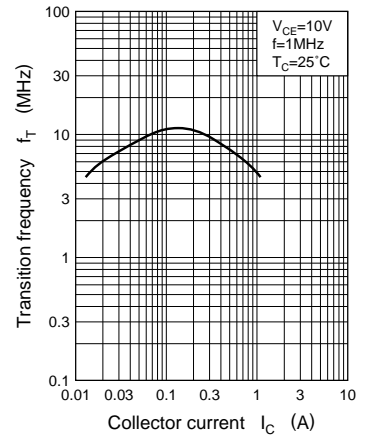

$C_{ob} - V_{CB}$

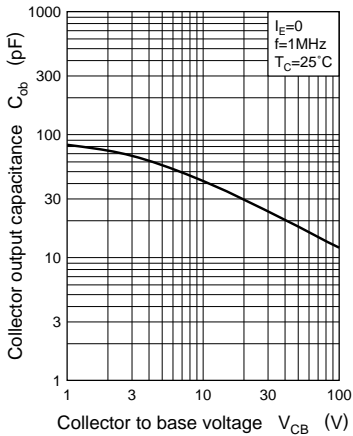

$t_{on}, t_{stg}, t_f - I_C$

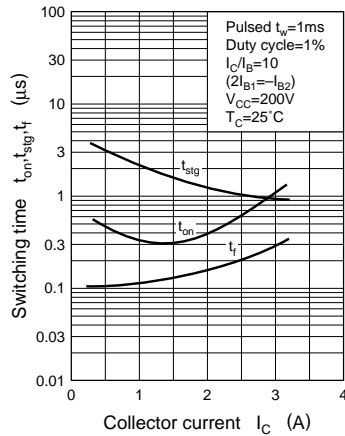

Area of safe operation (ASO)

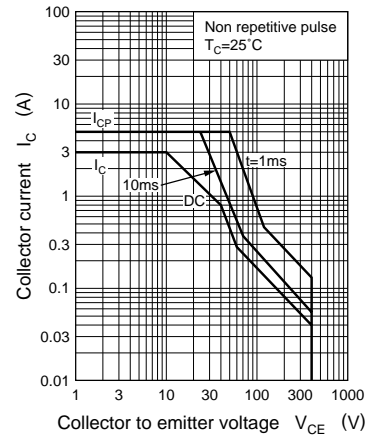

Area of safe operation, reverse bias ASO

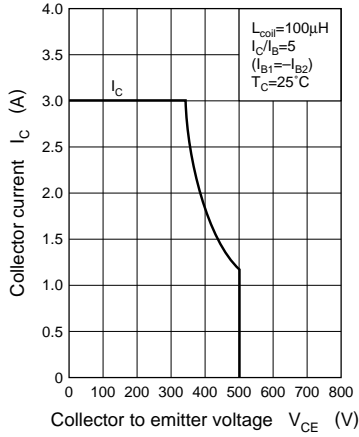

Reverse bias ASO measuring circuit

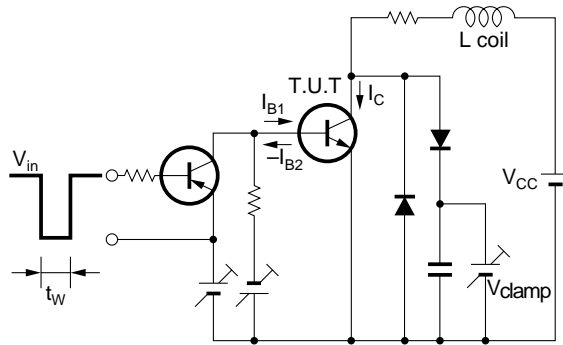

$R_{th(t)} - t$

