

2SC4434

Silicon NPN Triple Diffused Planar Transistor (High Voltage and High Speed Switching Transistor)

Application : Switching Regulator, Lighting Inverter, and General Purpose

Absolute maximum ratings (Ta=25°C)

Symbol	2SC4434	Unit
V _{CB0}	500	V
V _{CE0}	400	V
V _{EB0}	10	V
I _C	15(Pulse30)	A
I _B	5	A
P _C	120(T _C =25°C)	W
T _j	150	°C
T _{stg}	-55 to +150	°C

Electrical Characteristics (Ta=25°C)

Symbol	Conditions	2SC4434	Unit
I _{CB0}	V _{CB} =500V	100max	μA
I _{EB0}	V _{EB} =10V	100max	μA
V(BR) _{CEO}	I _C =25mA	400min	V
h _{FE}	V _{CE} =4V, I _C =8A	10to25	
V _{CE(sat)}	I _C =8A, I _B =1.6A	0.7max	V
V _{BE(sat)}	I _C =8A, I _B =1.6A	1.3max	V
f _r	V _{CE} =12V, I _E =-1.5A	10typ	MHZ
COB	V _{CB} =10V, f=1MHZ	135typ	pF

Typical Switching Characteristics (Common Emitter)

V _{CC} (V)	R _L (Ω)	I _C (A)	V _{BB1} (V)	V _{BB2} (V)	I _{B1} (A)	I _{B2} (A)	t _{on} (μs)	t _{stg} (μs)	t _r (μs)
200	25	8	10	-5	1.6	-3.2	0.5max	2.0max	0.15max

External Dimensions MT-100(TO3P)

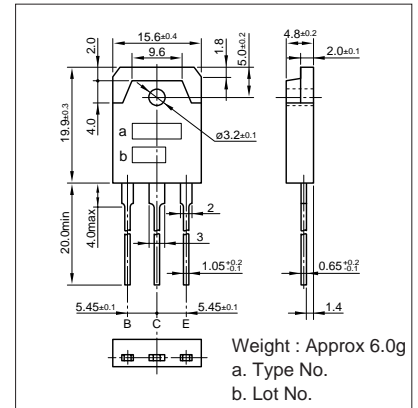

I_C-V_{CE} Characteristics (Typical)

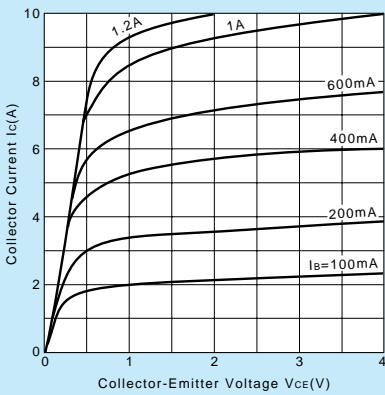

V_{CE(sat)}, V_{BE(sat)}-I_C Temperature Characteristics (Typical)

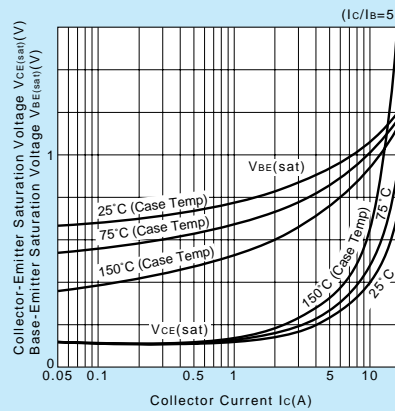

I_C-V_{BE} Temperature Characteristics (Typical)

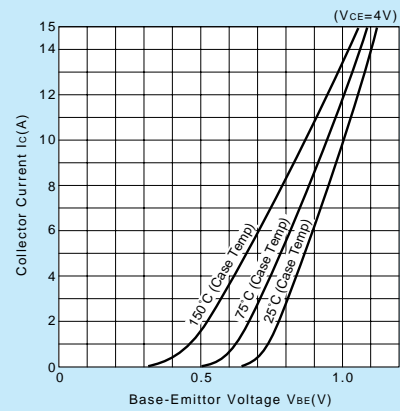

h_{FE}-I_C Temperature Characteristics (Typical)

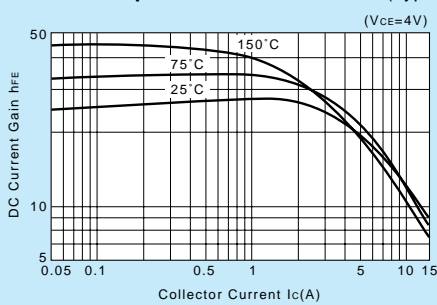

t_{on}*t_{stg}*t_r-I_C Characteristics (Typical)

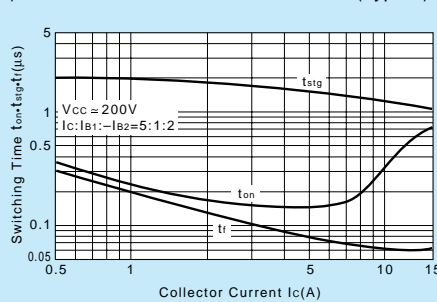

θ_{j-a-t} Characteristics

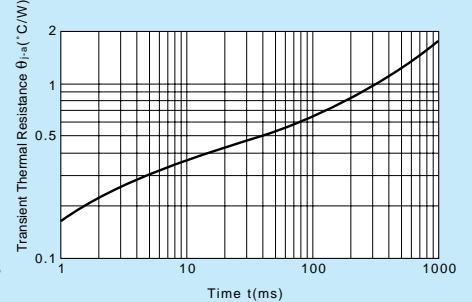

Safe Operating Area (Single Pulse)

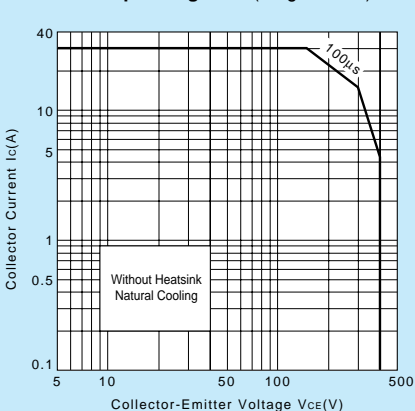

Reverse Bias Safe Operating Area

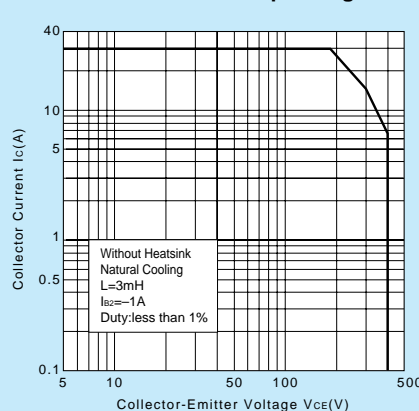

P_C-T_a Derating

