

**SANYO**

No.2236D

**2SC3993**

NPN Triple Diffused Planar Silicon Transistor

## Switching Regulator Applications

**Features**

- High breakdown voltage, high reliability.
- Fast switching speed.
- Wide ASO.
- Adoption of MBIT process.

**Absolute Maximum Ratings at  $T_a = 25^\circ\text{C}$** 

			unit
Collector-to-Base Voltage	$V_{CB0}$	1100	V
Collector-to-Emitter Voltage	$V_{CEO}$	800	V
Emitter-to-Base Voltage	$V_{EBO}$	7	V
Collector Current	$I_C$	16	A
Collector Current (Pulse)	$I_{CP}$	$PW \leq 300\mu\text{s}$ , Duty cycle $\leq 10\%$	40 A
Base Current	$I_B$	8	A
Collector Dissipation	$P_C$	$T_c = 25^\circ\text{C}$	250 W
Junction Temperature	$T_j$	150	$^\circ\text{C}$
Storage Temperature	$T_{stg}$	-55 to +150	$^\circ\text{C}$

**Electrical Characteristics at  $T_a = 25^\circ\text{C}$** 

			min	typ	max	unit
Collector Cutoff Current	$I_{CBO}$	$V_{CB} = 800\text{V}$ , $I_E = 0$			10	$\mu\text{A}$
Emitter Cutoff Current	$I_{EBO}$	$V_{EB} = 5\text{V}$ , $I_C = 0$			10	$\mu\text{A}$
DC Current Gain	$h_{FE(1)}$	$V_{CE} = 5\text{V}$ , $I_C = 1.2\text{A}$	10*		40*	
	$h_{FE(2)}$	$V_{CE} = 5\text{V}$ , $I_C = 6\text{A}$	8			
Gain-Bandwidth Product	$f_T$	$V_{CE} = 10\text{V}$ , $I_C = 1.2\text{A}$		15		MHz
Output Capacitance	$C_{ob}$	$V_{CB} = 10\text{V}$ , $f = 1\text{MHz}$		320		pF
C-E Saturation Voltage	$V_{CE(sat)}$	$I_C = 6\text{A}$ , $I_B = 1.2\text{A}$			2.0	V
B-E Saturation Voltage	$V_{BE(sat)}$	$I_C = 6\text{A}$ , $I_B = 1.2\text{A}$			1.5	V
C-B Breakdown Voltage	$V_{(BR)CBO}$	$I_C = 1\text{mA}$ , $I_E = 0$	1100			V
C-E Breakdown Voltage	$V_{(BR)CEO}$	$I_C = 10\text{mA}$ , $R_{BE} = \infty$	800			V
E-B Breakdown Voltage	$V_{(BR)EBO}$	$I_E = 1\text{mA}$ , $I_C = 0$	7			V
C-E Sustain Voltage	$V_{CEX(sus)}$	$I_C = 8\text{A}$ , $I_{B1} = -I_{B2} = 1.6\text{A}$ , $L = 500\mu\text{H}$ , Clamped	800			V
Rise Time	$t_{on}$	$V_{CC} = 400\text{V}$ ,			0.5	$\mu\text{s}$
Storage Time	$t_{stg}$	$5I_{B1} = -2.5I_{B2} = I_C = 10\text{A}$ ,			3.0	$\mu\text{s}$
Fall Time	$t_f$	$R_L = 40\Omega$			0.3	$\mu\text{s}$

\* : The 2SC3993 are classified by 1.2A  $h_{FE}$  as follows :

10 K 20	15 L 30	20 M 40
---------	---------	---------

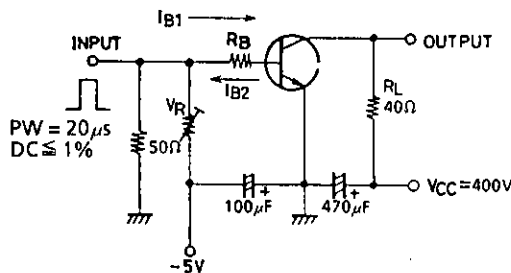
**Switching Time Test Circuit****Package Dimensions 2048B**

(unit: mm)

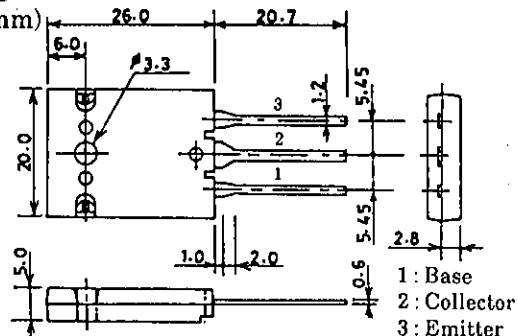

SANYO: TO-3PBL

**SANYO Electric Co., Ltd. Semiconductor Business Headquarters**

TOKYO OFFICE Tokyo Bldg., 1-10, 1 Chome, Ueno, Taito-ku, TOKYO, 110 JAPAN

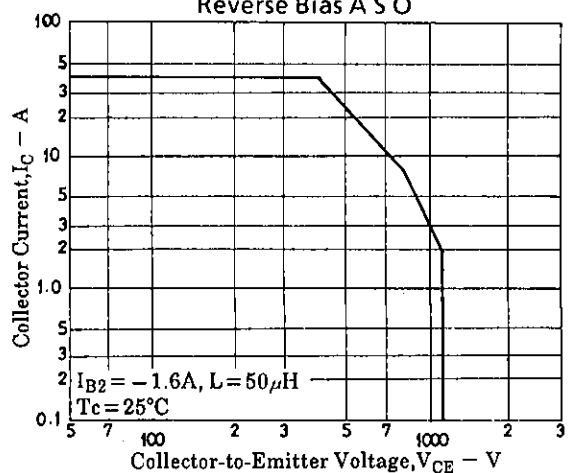
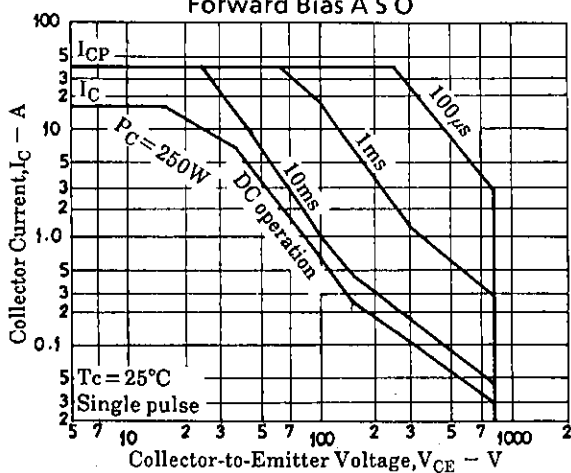
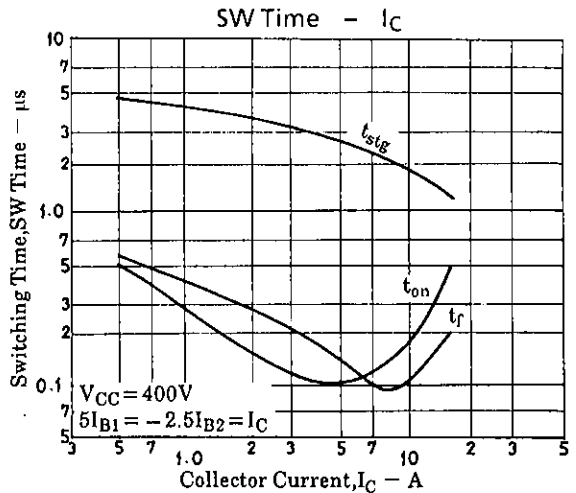
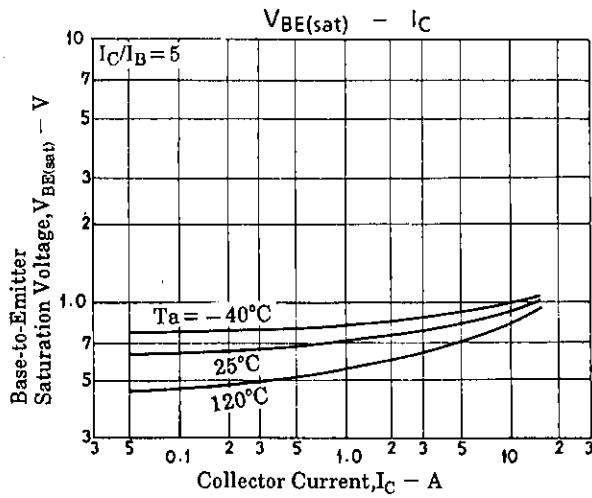
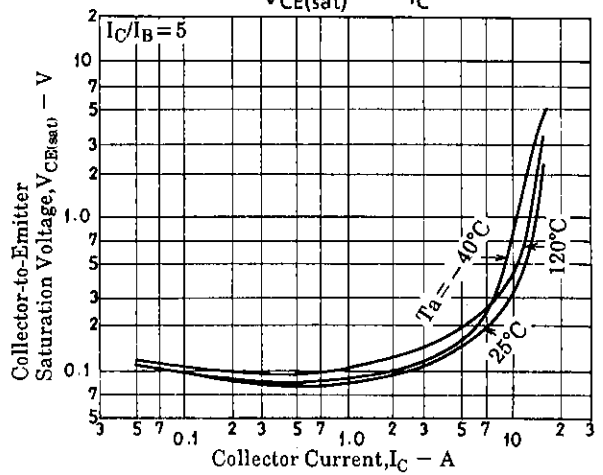
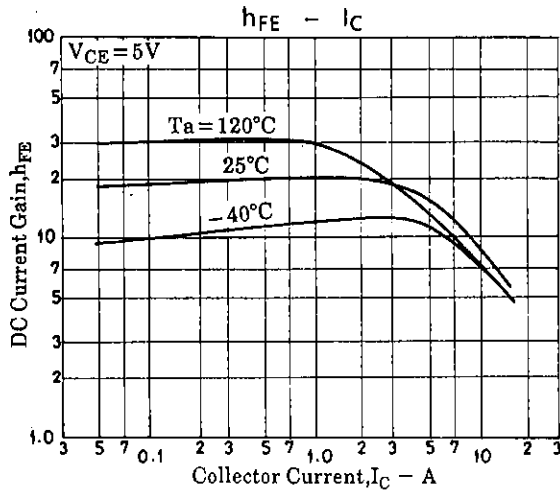
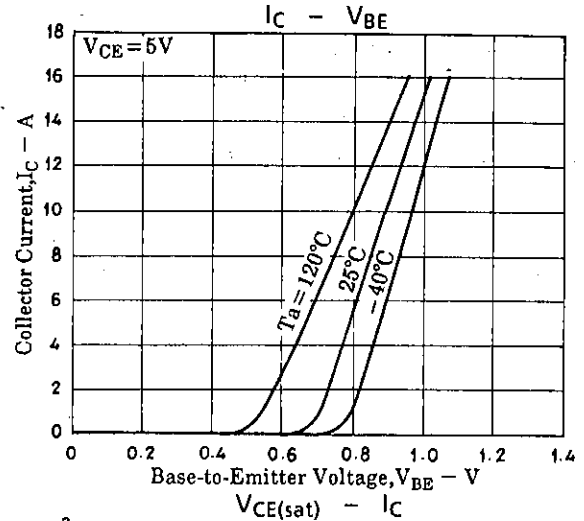
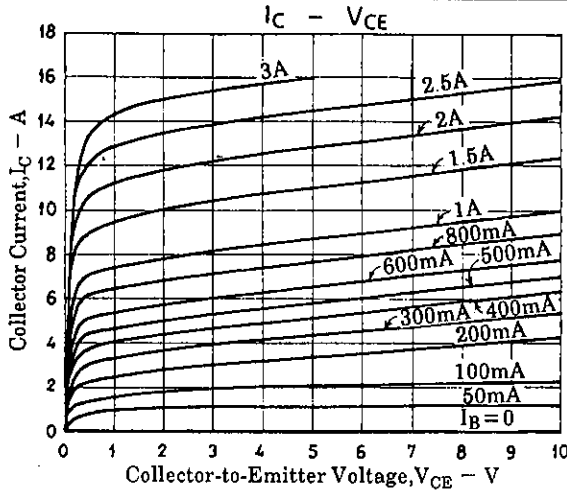

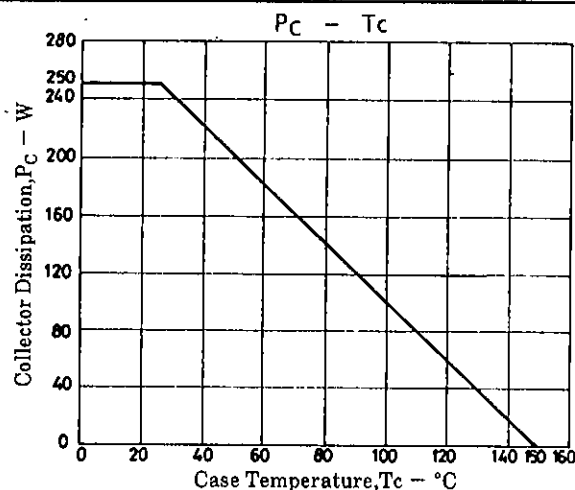
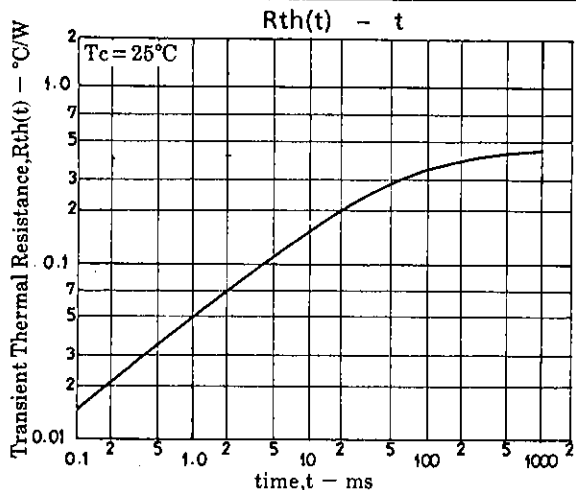

- No products described or contained herein are intended for use in surgical implants, life-support systems, aerospace equipment, nuclear power control systems, vehicles, disaster/crime-prevention equipment and the like, the failure of which may directly or indirectly cause injury, death or property loss.
- Anyone purchasing any products described or contained herein for an above-mentioned use shall:
  - ① Accept full responsibility and indemnify and defend SANYO ELECTRIC CO., LTD., its affiliates, subsidiaries and distributors and all their officers and employees, jointly and severally, against any and all claims and litigation and all damages, cost and expenses associated with such use;
  - ② Not impose any responsibility for any fault or negligence which may be cited in any such claim or litigation on SANYO ELECTRIC CO., LTD., its affiliates, subsidiaries and distributors or any of their officers and employees jointly or severally.
- Information (including circuit diagrams and circuit parameters) herein is for example only; it is not guaranteed for volume production. SANYO believes information herein is accurate and reliable, but no guarantees are made or implied regarding its use or any infringements of intellectual property rights or other rights of third parties.

This catalog provides information as of September, 1996. Specifications and information herein are subject to change without notice.