

2SA1502, 2SC3863



2018A

T-37-13
T-35-11

PNP/NPN Epitaxial Planar
Silicon Transistors

Switching Applications (with Bias Resistances $R1=2.2k\Omega$, $R2=10k\Omega$)

©2108A

Applications

- Switching circuits, inverter circuits, interface circuits, driver circuits

Features

- On-chip bias resistance: $R1=2.2k\Omega$, $R2=10k\Omega$
- Small-sized package: CP

(): 2SA1502.

Absolute Maximum Ratings at $T_a=25^\circ\text{C}$

			unit
Collector to Base Voltage	V_{CBO}	(-)50	V
Collector to Emitter Voltage	V_{CEO}	(-)50	V
Emitter to Base Voltage	V_{EBO}	(-)6	V
Collector Current	I_C	(-)100	mA
Peak Collector Current	i_C	(-)200	mA
Collector Dissipation	P_{CP}	200	mW
Junction Temperature	T_J	150	$^\circ\text{C}$
Storage Temperature	T_{stg}	-55 to +150	$^\circ\text{C}$

Electrical Characteristics at $T_a=25^\circ\text{C}$

			min	typ	max	unit
Collector Cutoff Current	I_{CBO}	$V_{CB}=(-)40V, I_E=0$			(-)0.1	μA
Collector Cutoff Current	I_{CEO}	$V_{CE}=(-)40V, I_B=0$			(-)0.5	μA
Emitter Cutoff Current	I_{ERO}	$V_{EB}=(-)5V, I_C=0$	(-)315	(-)410	(-)590	μA
DC Current Gain	h_{FE}	$V_{CE}=(-)5V, I_C=(-)10\text{mA}$	50			
Gain-Bandwidth Product	f_T	$V_{CE}=(-)10V, I_C=(-)5\text{mA}$		250		MHz
				(200)		MHz
Output Capacitance	c_{ob}	$V_{CB}=(-)10V, f=1\text{MHz}$		3.5		pF
				(5.3)		pF
Collector to Emitter Saturation Voltage	$V_{CE(sat)}$	$I_C=(-)10\text{mA}, I_B=(-)0.5\text{mA}$	(-)0.1	(-)0.3		V

Continued on next page.

Marking: 2SA1502: HL, 2SC3863: QY

Electrical Connection

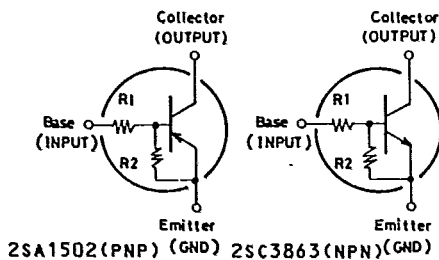

Case Outline 2018A (unit:mm)

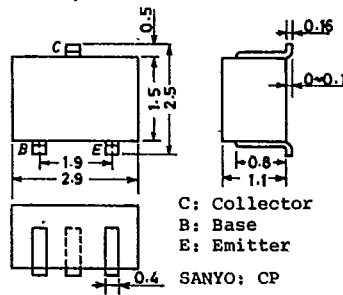

2SA1502/2SC3863

T-37-13

T-35-11

Continued from preceding page.

			min	typ	max	unit
Collector to Base Breakdown Voltage	$V_{(BR)CBO}$	$I_C = (-)10\mu A, I_E = 0$	(-)50			V
Collector to Emitter Breakdown Voltage	$V_{(BR)CEO}$	$I_C = (-)100\mu A, R_{BE} = \infty$	(-)50			V
Input OFF Voltage	$V_{I(off)}$	$V_{CE} = (-)5V, I_C = 100\mu A$	(-)0.5	(-)0.7	(-)0.9	V
Input ON Voltage	$V_{I(on)}$	$V_{CE} = (-)0.2V, I_C = (-)10mA$	(-)0.7	(-)1.0	(-)1.8	V
Input Resistance	R1		1.5	2.2	2.9	kohm
Resistance Ratio	R1/R2		0.198	0.22	0.242	

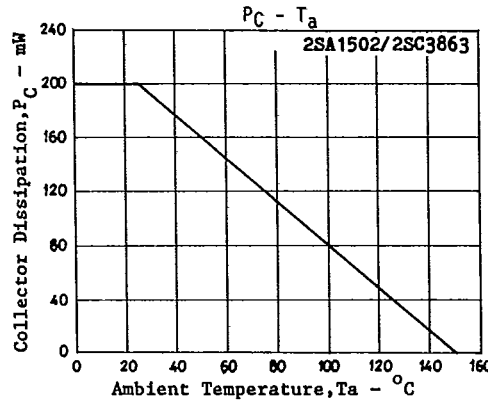
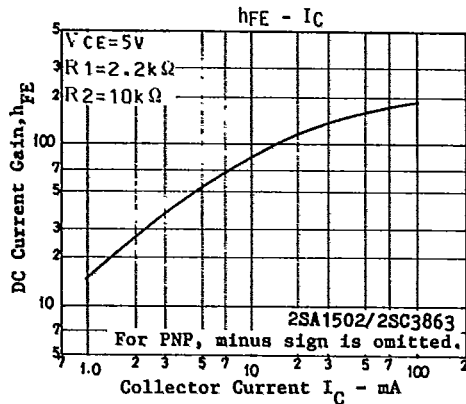
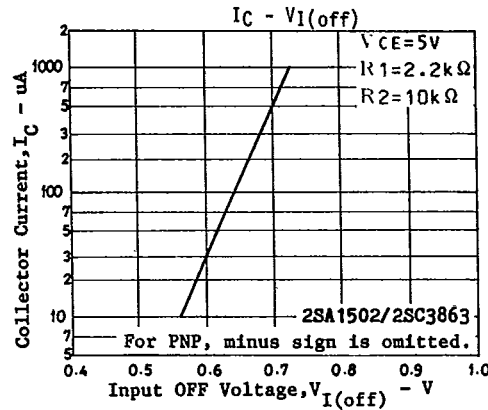
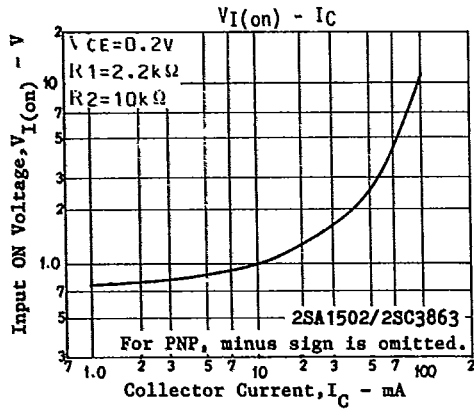

T-91-20

CASE OUTLINES OF SURFACE MOUNT TRANSISTORS

- All of Sanyo surface mount transistor case outlines are illustrated below.
- All dimensions are in mm, and dimensions which are not followed by min. or max. are represented by typical values.
- No marking is indicated.

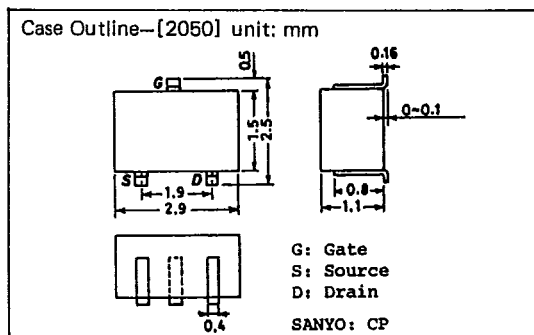
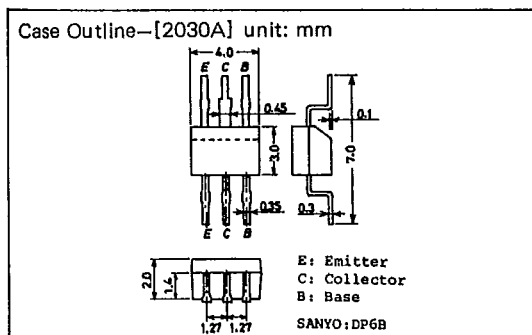
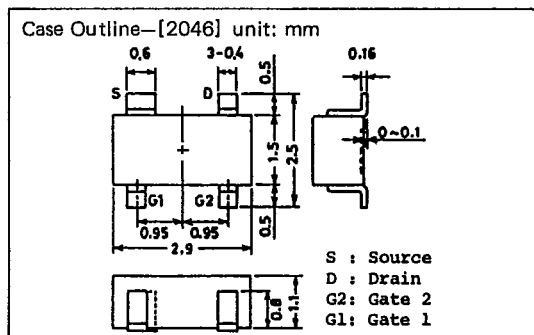
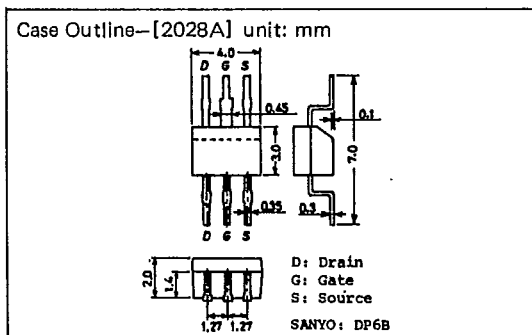
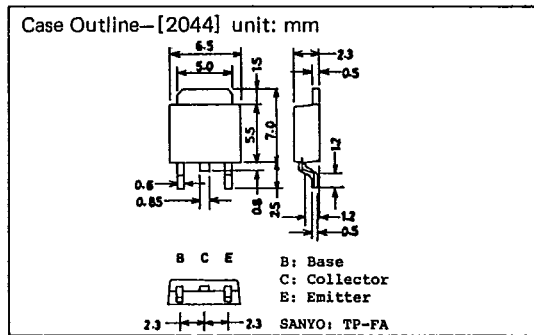
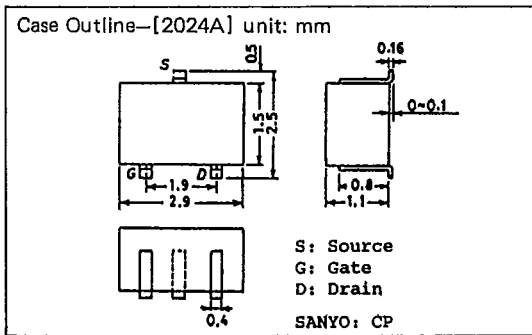
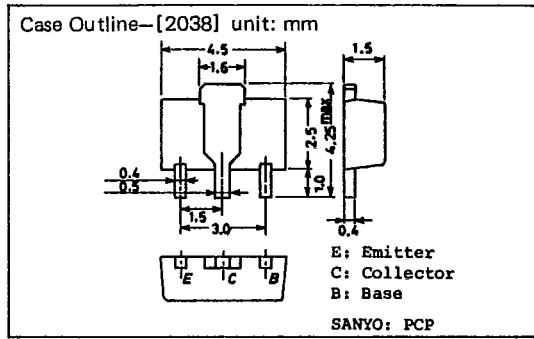
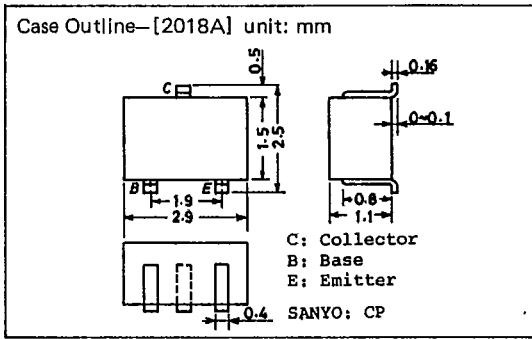

T-91-20

Case Outline—[2057] unit: mm

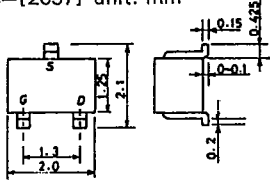

S: Source
G: Gate
D: Drain
SANYO: MCP

Case Outline—[2066] unit: mm

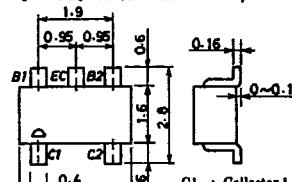

C1 : Collector 1
C2 : Collector 2
B2 : Base 2
EC : Emitter Common
B1 : Base 1
SANYO : CP6

Case Outline—[2058] unit: mm

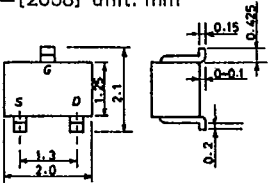

G: Gate
S: Source
D: Drain
SANYO: MCP

Case Outline—[2067] unit: mm

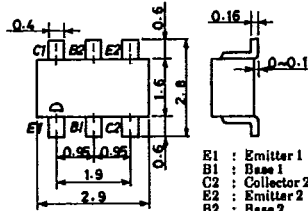

E1 : Emitter 1
B1 : Base 1
C2 : Collector 2
E2 : Emitter 2
B2 : Base 2
C1 : Collector 1
SANYO : CP6

Case Outline—[2059] unit: mm

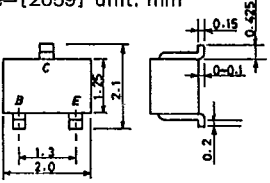

B: Base
C: Collector
E: Emitter
SANYO: MCP

Case Outline—[2068] unit: mm

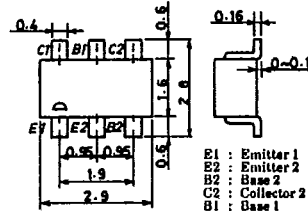

B1 : Emitter 1
E2 : Emitter 2
B2 : Base 2
C2 : Collector 2
B1 : Base 1
C1 : Collector 1
SANYO : CP6

Case Outline—[2062] unit: mm

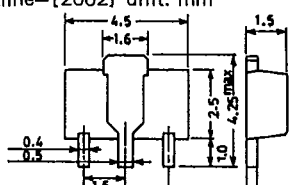

S: Source
D: Drain
G: Gate
SANYO: PCP

Case Outline—[2069] unit: mm

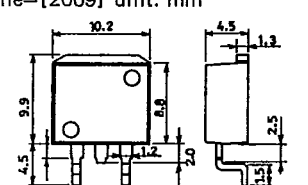

B: Base
C: Collector
E: Emitter
SANYO: SMP

Case Outline—[2065] unit: mm

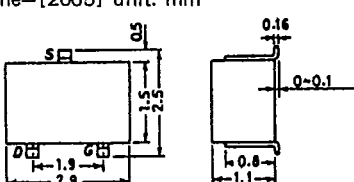

S: Source
D: Drain
G: Gate
SANYO: CP

Case Outline—[2070] unit: mm

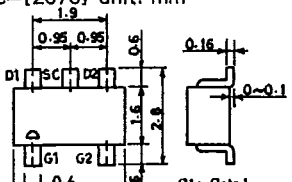

G1 : Gate 1
G2 : Gate 2
D2 : Drain 2
SC : Source Common
D1 : Drain 1
SANYO : CP6

T-9120

