

HIGH SPEED SWITCHING
NPN SILICON EPITAXIAL TRANSISTOR
POWER MINI MOLD

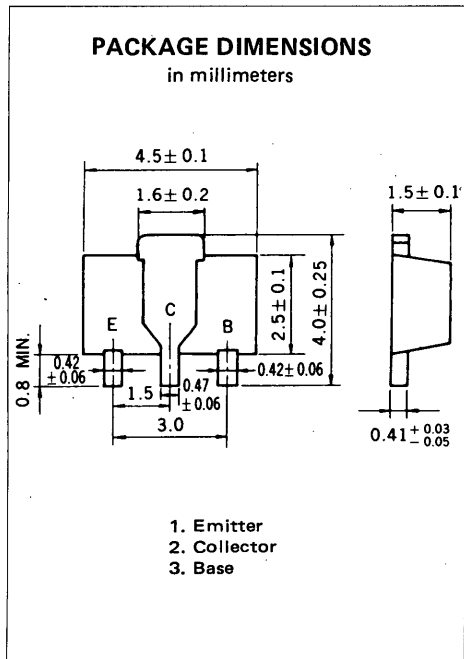

DESCRIPTION The 2SC3736 is designed for power amplifier and high speed switching applications.

- FEATURES**
- High speed, high voltage switching.
 - Low Collector Saturation Voltage.
 - Complementary to the NEC 2SA1460 PNP transistor.

ABSOLUTE MAXIMUM RATINGS

Maximum Voltages and Currents ($T_a = 25^\circ\text{C}$)

Collector to Base Voltage	V_{CB0}	80	V
Collector to Emitter Voltage	V_{CEO}	45	V
Emitter to Base Voltage	V_{EBO}	5.0	V
Collector Current (DC)	I_C	1.0	A
Collector Current (Pulse)*	I_C	2.0	A

Maximum Power Dissipation

Total Power Dissipation at 25°C Ambient Temperature**	P_T	2.0	W
--	-------	-----	---

Maximum Temperatures

Junction Temperature	T_j	150	$^\circ\text{C}$
Storage Temperature Range	T_{stg}	-55 to +150	$^\circ\text{C}$

* $PW \leq 10$ ms, Duty Cycle $\leq 50\%$

** When mounted on ceramic substrate of $16\text{ cm}^2 \times 0.7$ mm

ELECTRICAL CHARACTERISTICS ($T_a = 25^\circ\text{C}$)

CHARACTERISTIC	SYMBOL	MIN.	TYP.	MAX.	UNIT	TEST CONDITIONS
Collector Cutoff Current	I_{CES}			0.5	μA	$V_{CE} = 45\text{ V}, R_{BE} = 0$
Emitter Cutoff Current	I_{EBO}			0.5	μA	$V_{EB} = 4.0\text{ V}, I_C = 0$
DC Current Gain	h_{FE}	60		200		$V_{CE} = 10\text{ V}, I_C = 50\text{ mA}$
Collector Saturation Voltage	$V_{CE(sat)}$		0.17	0.4	V	$I_C = 500\text{ mA}, I_B = 50\text{ mA}$
Base Saturation Voltage	$V_{BE(sat)}$		0.90	1.2	V	
Gain Bandwidth Product	f_T	300	380		MHz	$V_{CE} = 10\text{ V}, I_E = -100\text{ mA}$
Output Capacitance	C_{ob}		6.7	10	pF	$V_{CB} = 10\text{ V}, I_E = 0, f = 1.0\text{ MHz}$
Turn-on Time	t_{on}		20	40	ns	$I_C = 500\text{ mA}$ $I_{B1} = -I_{B2} = 50\text{ mA}$
Storage Time	t_{stg}		55	80	ns	
Turn-off Time	t_{off}		72	100	ns	

*** Pulsed: $PW \leq 350\ \mu\text{s}$, Duty Cycle $\leq 2\%$

h_{FE} Classification

MARKING	OL	OK
h_{FE}	60 to 120	100 to 200

TYPICAL CHARACTERISTICS ($T_a = 25^\circ\text{C}$)

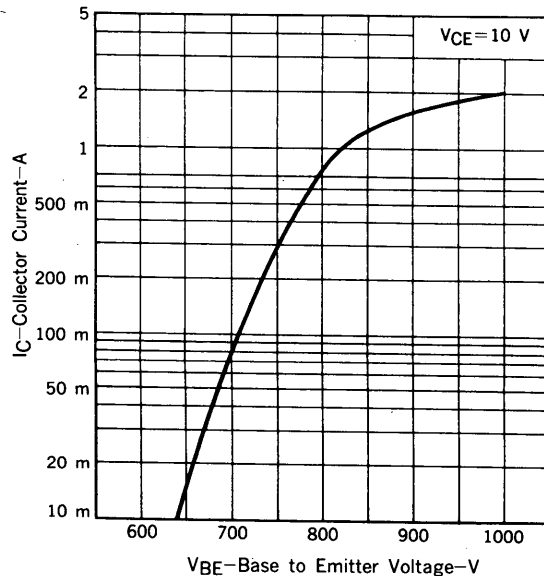
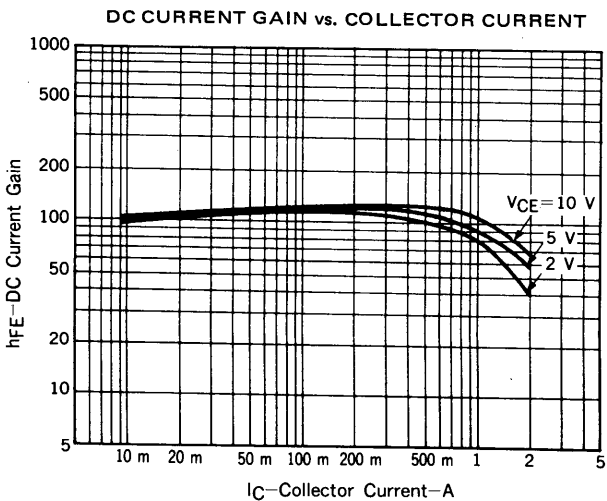
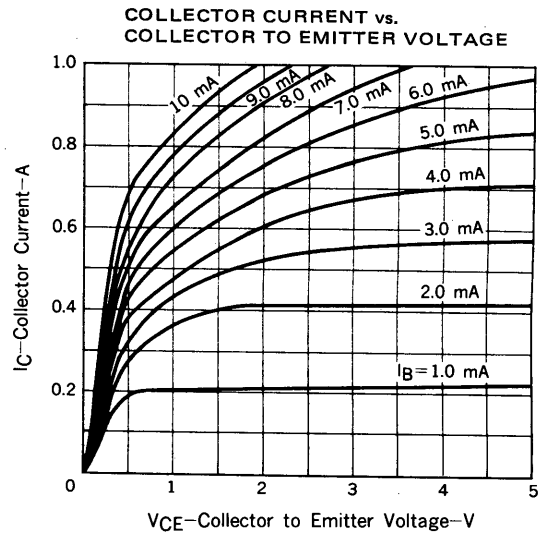
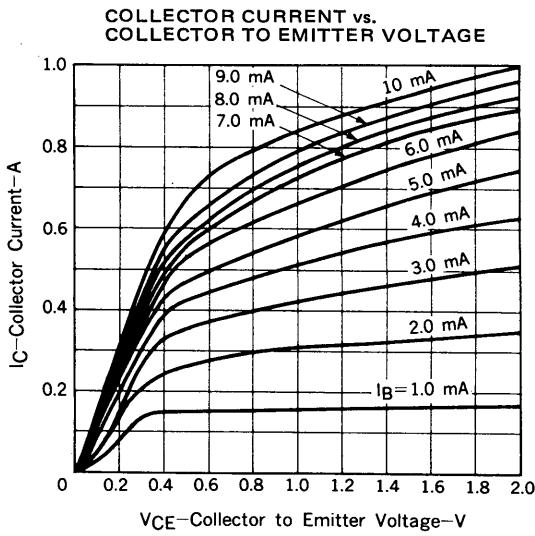
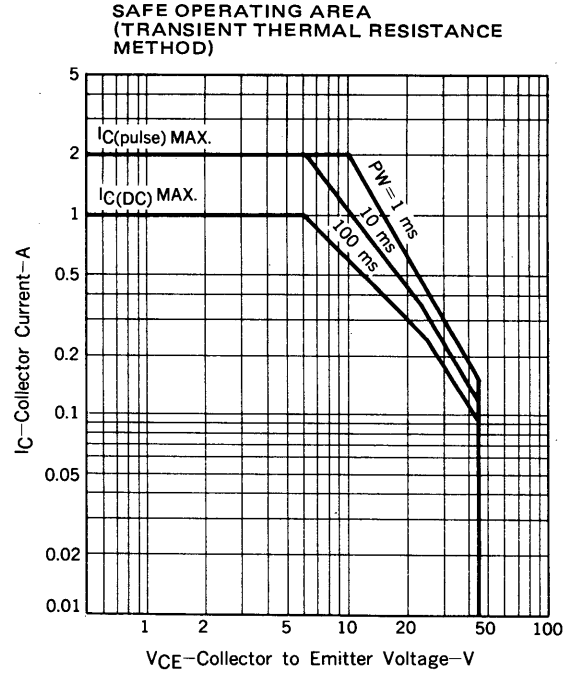
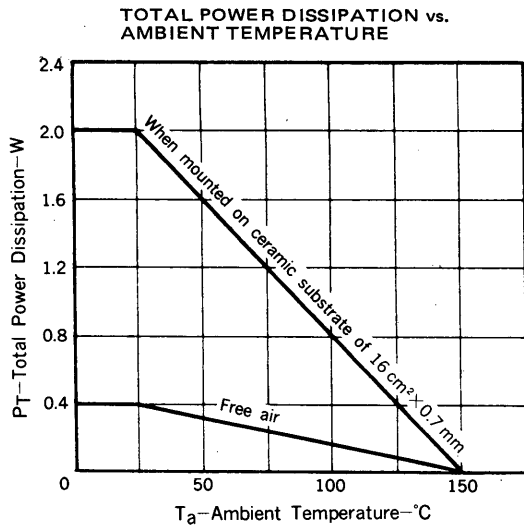

BASE AND COLLECTOR SATURATION VOLTAGE vs. COLLECTOR CURRENT

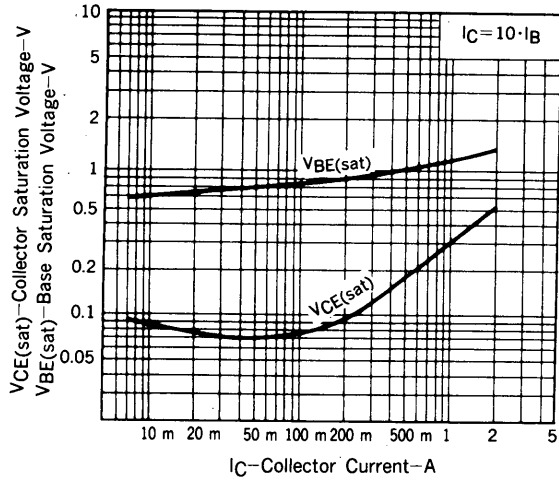

GAIN BANDWIDTH PRODUCT vs. EMITTER CURRENT

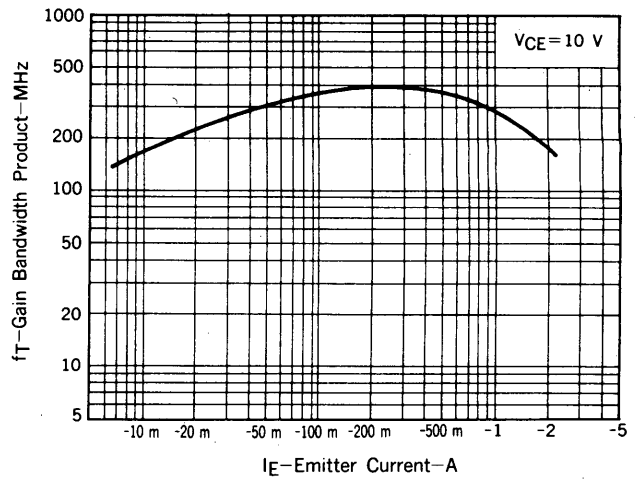

OUTPUT CAPACITANCE vs. REVERSE VOLTAGE

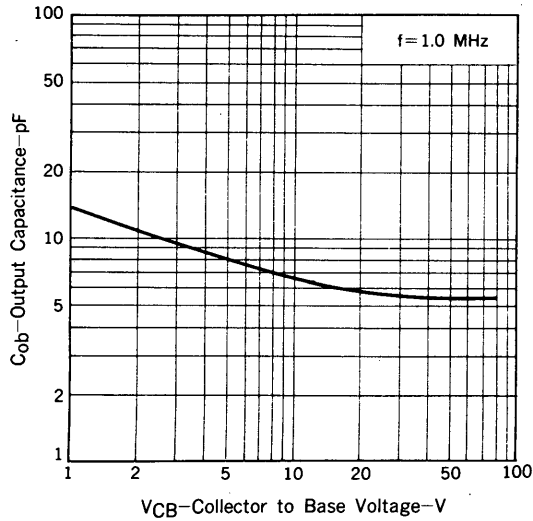

SWITCHING TIME vs. COLLECTOR CURRENT

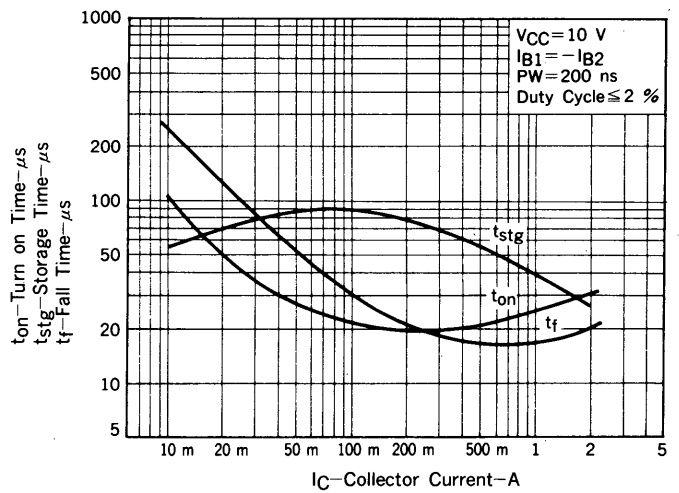

SWITCHING TIME TEST CIRCUIT

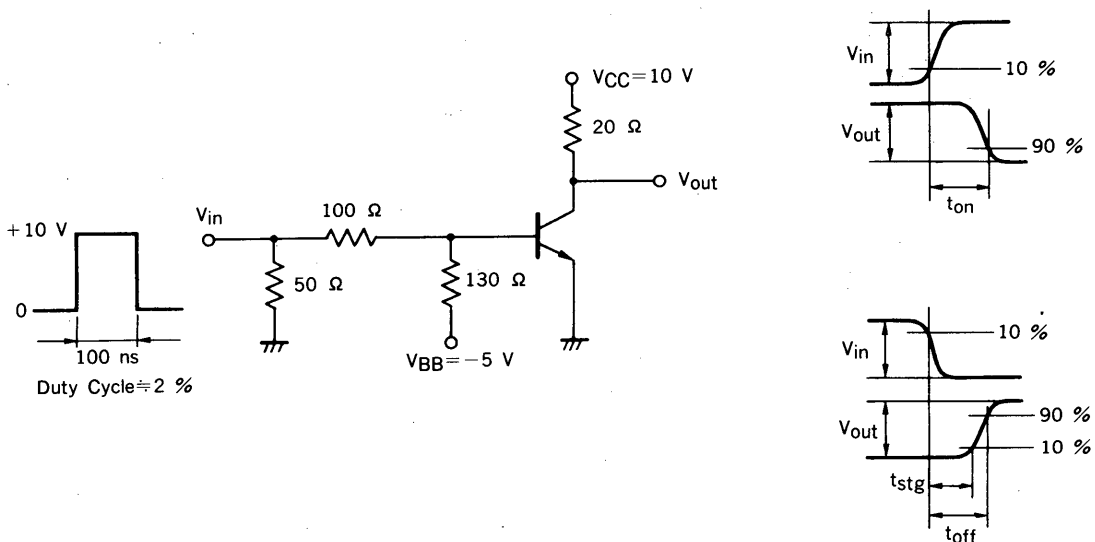

REFERENCE

Document Name	Document No.
NEC semiconductor device reliability/quality control system.	TEI-1202
Quality grade on NEC semiconductor devices.	IEI-1209
Semiconductor device mounting technology manual.	IEI-1207
Semiconductor device package manual.	IEI-1213
Guide to quality assurance for semiconductor devices.	MEI-1202
Semiconductor selection guide.	MF-1134

No part of this document may be copied or reproduced in any form or by any means without the prior written consent of NEC Corporation. NEC Corporation assumes no responsibility for any errors which may appear in this document.

NEC Corporation does not assume any liability for infringement of patents, copyrights or other intellectual property rights of third parties by or arising from use of a device described herein or any other liability arising from use of such device. No license, either express, implied or otherwise, is granted under any patents, copyrights or other intellectual property rights of NEC Corporation or others.

The devices listed in this document are not suitable for use in aerospace equipment, submarine cables, nuclear reactor control systems and life support systems. If customers intend to use NEC devices for above applications or they intend to use "Standard" quality grade NEC devices for applications not intended by NEC, please contact our sales people in advance.

Application examples recommended by NEC Corporation

Standard: Computer, Office equipment, Communication equipment, Test and Measurement equipment, Machine tools, Industrial robots, Audio and Visual equipment, Other consumer products, etc.

Special: Automotive and Transportation equipment, Traffic control systems, Antidisaster systems, Anticrime systems, etc.