

No. 1332A

2SC3292

NPN Planar Type Silicon Darlington Transistor

FOR GENERAL-PURPOSE DRIVERS

Use:

- Especially suited for use in switching of L load motor driver, printer hammer driver, relay driver, etc.

Features:

- High DC current gain
- Large current capacity and wide ASO
- Contains 60±10 V zener diode between collector and base
- Uniformity in collector-to-base breakdown voltage due to adoption of accurate impurity diffusion process
- 15 mJ reverse energy rating

Absolute Maximum Ratings/ $T_a = 25^\circ\text{C}$

			unit	
Collector to base voltage	V_{CB0}	50*	V	*:Built-in
Collector to emitter voltage	V_{CE0}	50*	V	Zener Diode
Emitter to base voltage	V_{EB0}	6	V	(60±10 V)
Collector current	I_C	1.2	A	
Peak collector current	I_{cp}	2.5	A	
Base current	I_B	0.25	A	
Collector dissipation	P_C	20	W	$T_c=25^\circ\text{C}$
Junction temperature	T_j	150	$^\circ\text{C}$	
Storage temperature	T_{stg}	-55 ~ +150	$^\circ\text{C}$	

Electrical Characteristics/ $T_a = 25^\circ\text{C}$

			min	typ	max	unit
Collector cutoff current	I_{CBO}	$V_{CB}=40\text{ V}, I_E=0$			10	μA
Emitter cutoff current	I_{EBO}	$V_{EB}=5\text{ V}, I_C=0$			2	mA
DC current gain	h_{FE}	$V_{CE}=5\text{ V}, I_C=0.5\text{ A}$	1000	4000		
Gain bandwidth product	f_T	$V_{CE}=5\text{ V}, I_C=0.5\text{ A}$		180		MHz
C-E saturation voltage	$V_{CE(sat)}$	$I_C=0.5\text{ A}, I_B=2\text{ mA}$		1.0	1.5	V
B-E saturation voltage	$V_{BE(sat)}$	$I_C=0.5\text{ A}, I_B=2\text{ mA}$			2.0	V
C-B breakdown voltage	$V_{(BR)CBO}$	$I_C=0.1\text{ mA}, I_E=0$	50	60	70	V
C-E breakdown voltage	$V_{(BR)CEO}$	$I_C=1\text{ mA}, R_{BE}=\infty$	50	60	70	V
Unclamped inductive load energy	E_s/b	$L=100\text{ mH}, R_{BE}=100\Omega$	15			mJ
Turn-on time	t_{on}	$V_{CC}=20\text{ V}, I_C=0.5\text{ A}$		0.2		μs
Storage time	t_{stg}	$I_{B1}=-I_{B2}=2\text{ mA}$		2.2		μs
Fall time	t_f			0.4		μs

Switching Time Test Circuit

$PW=50\mu\text{s}$, Duty Cycle $\leq 1\%$

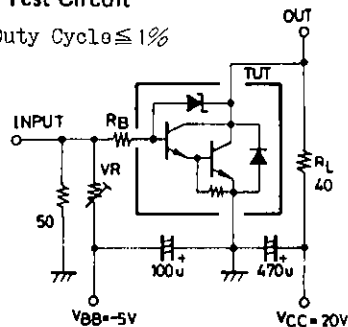

Unit (resistance: Ω , capacitance: F)

Package Dimensions 2010A
(unit: mm)

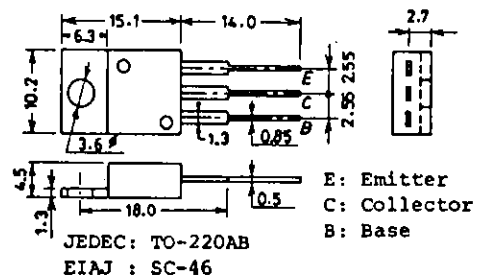

Es/b Test Circuit

$V_{CC} = 20V, R_{BE} = 100\Omega$

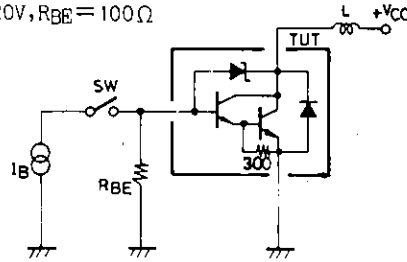

Unit (resistance: Ω)

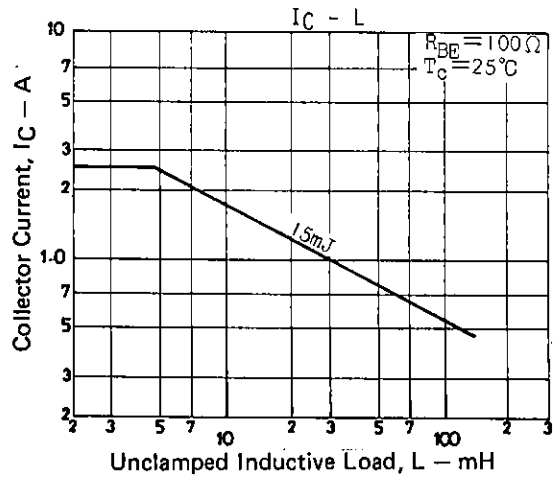
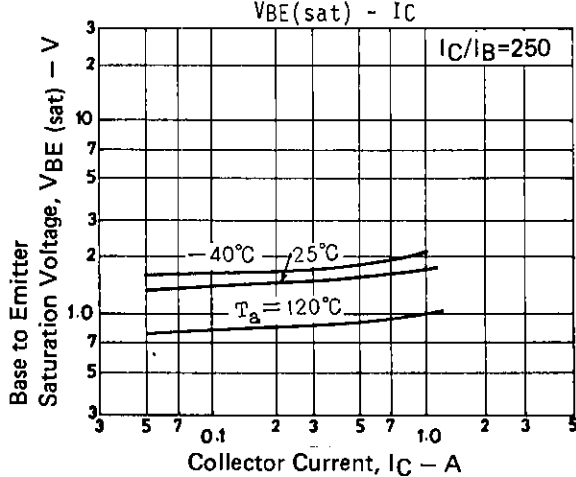
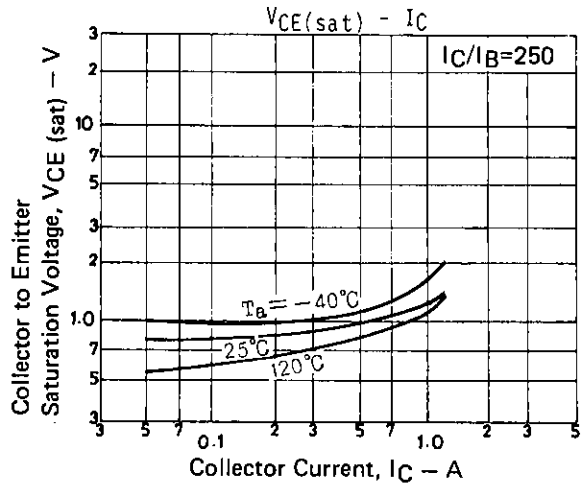
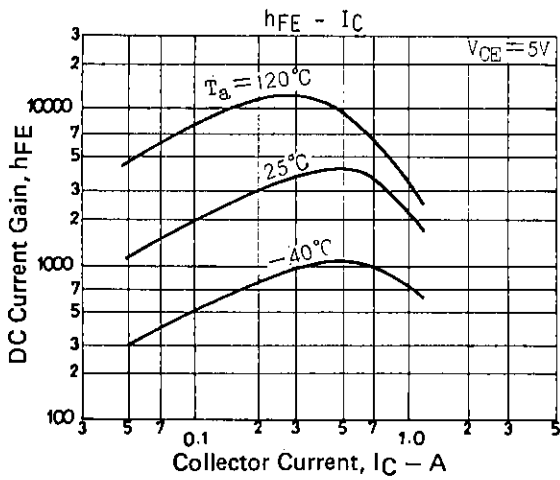
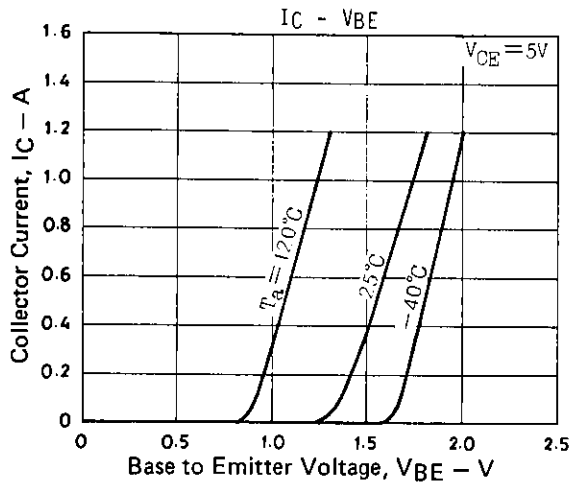
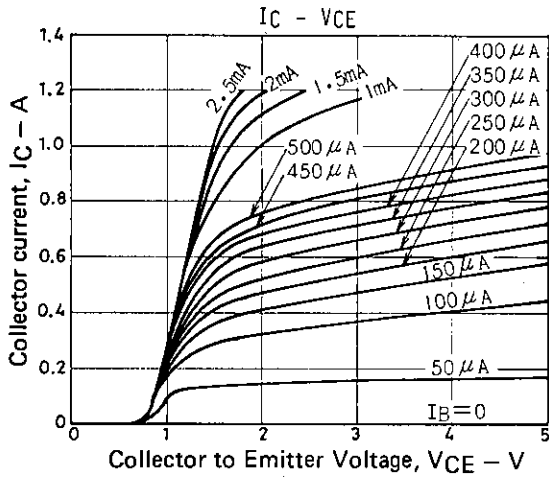

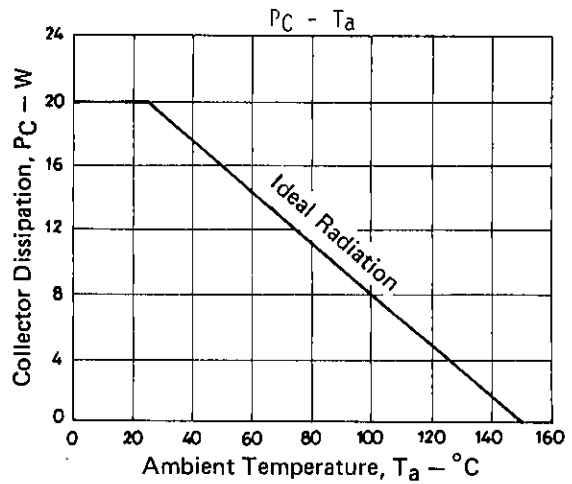
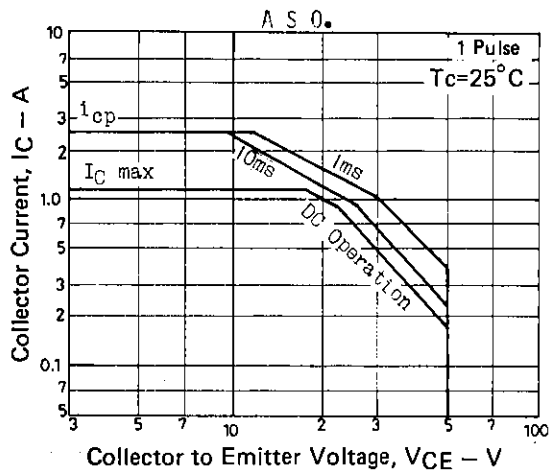

■ No products described or contained herein are intended for use in surgical implants, life-support systems, aerospace equipment, nuclear power control systems, vehicles, disaster/crime-prevention equipment and the like, the failure of which may directly or indirectly cause injury, death or property loss.

■ Anyone purchasing any products described or contained herein for an above-mentioned use shall:

- ① Accept full responsibility and indemnify and defend SANYO ELECTRIC CO., LTD., its affiliates, subsidiaries and distributors and all their officers and employees, jointly and severally, against any and all claims and litigation and all damages, cost and expenses associated with such use;
- ② Not impose any responsibility for any fault or negligence which may be cited in any such claim or litigation on SANYO ELECTRIC CO., LTD., its affiliates, subsidiaries and distributors or any of their officers and employees jointly or severally.

■ Information (including circuit diagrams and circuit parameters) herein is for example only; it is not guaranteed for volume production. SANYO believes information herein is accurate and reliable, but no guarantees are made or implied regarding its use or any infringements of intellectual property rights or other rights of third parties.