

DESCRIPTION

2SC3104 is a silicon NPN epitaxial planar type transistor specifically designed for UHF power amplifier applications.

FEATURES

- High power gain: $G_{pe} \geq 4.7\text{dB}$
@ $V_{CC} = 7.2\text{V}$, $f = 520\text{MHz}$, $P_{in} = 2\text{W}$.
- Emitter ballasted construction.
- High ruggedness: Ability to withstand more than 20:1 load VSWR when operated at $V_{CC} = 9\text{V}$, $f = 520\text{MHz}$, $P_O = 6\text{W}$.
- Flange type ceramic package.
- $Z_{in} = 1.6 - 0.4\ \Omega$, $Z_{out} = 3.5 - j1.0\ \Omega$ at $V_{CC} = 7.2\text{V}$, $f = 520\text{MHz}$, $P_O = 6\text{W}$.

APPLICATION

For output stage of 5W power amplifiers in UHF band portable type radio set.

OUTLINE DRAWING

Dimensions in mm

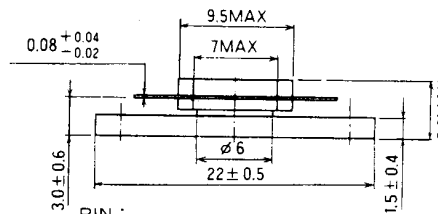
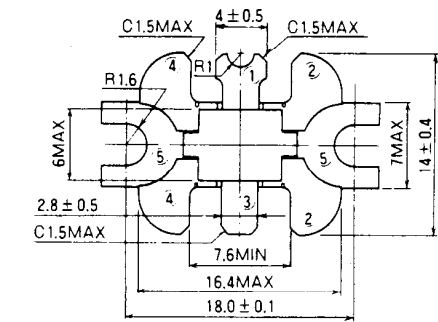

PIN :

- ① COLLECTOR
- ② EMITTER (FLANGE)
- ③ BASE
- ④ EMITTER (FLANGE)
- ⑤ FIN (EMITTER)

T-31E

ABSOLUTE MAXIMUM RATINGS ($T_C = 25^\circ\text{C}$)

Symbol	Parameter	Conditions	Ratings	Unit
V_{CBO}	Collector to base voltage		20	V
V_{EBO}	Emitter to base voltage		3.5	V
V_{CEO}	Collector to emitter voltage	$R_{BE} = \infty$	9	V
I_C	Collector current		3	A
P_C	Collector dissipation	$T_C = 25^\circ\text{C}$	20	W
T_J	Junction temperature		175	$^\circ\text{C}$
T_{stg}	Storage temperature		-55 to 175	$^\circ\text{C}$
R_{th-c}	Thermal resistance	Junction to case	7.5	$^\circ\text{C/W}$

Note. Above parameters are guaranteed independently.

ELECTRICAL CHARACTERISTICS ($T_C = 25^\circ\text{C}$)

Symbol	Parameter	Test conditions	Limits			Unit
			Min	Typ	Max	
$V_{IBR1EBO}$	Emitter to base breakdown voltage	$I_E = 5\text{mA}$, $I_C = 0$	3.5			V
$V_{IBR1CBO}$	Collector to base breakdown voltage	$I_C = 10\text{mA}$, $I_E = 0$	20			V
$V_{IBR1CEO}$	Collector to emitter breakdown voltage	$I_C = 50\text{mA}$, $R_{BE} = \infty$	9			V
I_{CBO}	Collector cut off current	$V_{CB} = 10\text{V}$, $I_E = 0$			500	μA
I_{EBO}	Emitter cut off current	$V_{EB} = 2\text{V}$, $I_C = 0$			500	μA
h_{FE}	DC forward current gain *	$V_{CE} = 5\text{V}$, $I_C = 0.1\text{A}$	10	50	180	—
P_O	Power Output	$V_{CC} = 7.2\text{V}$, $P_{in} = 2\text{W}$, $f = 520\text{MHz}$	6	7		W
η_C	Collector efficiency		60	65		%

Note. * Pulse test, $P_W = 150\mu\text{s}$, duty = 5%.

Above parameters, limits and conditions are subject to change.

NPN EPITAXIAL PLANAR TYPE

TEST CIRCUIT (f = 520MHz)

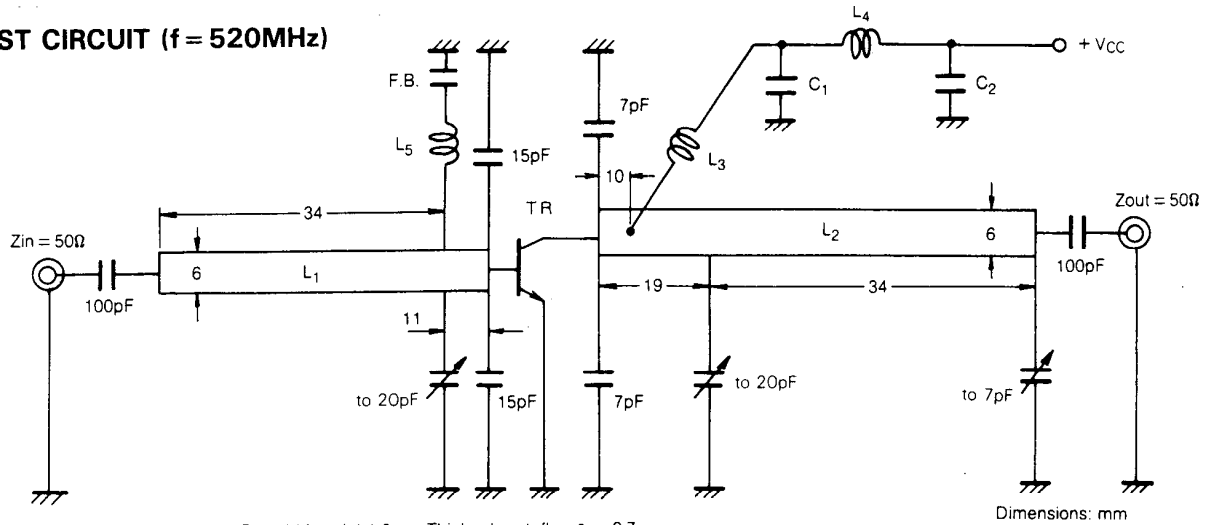

- L₁, L₂: Microstrip: Board Material 1.6mm Thick, glass-tyeflon $\epsilon_r = 2.7$
- L₃: 3 Turns AWG #20, 5mm I.D.
- L₄: 6 Turns AWG #20, 5mm I.D.
- L₅: 10 Turns AWG #26 Enameled Wire on 4mm O.D., 14mm Length Bakelite.

- F.B.: Ferrite Bead
- C₁: 82pF, 220pF, 4700pF, 10 μ F in parallel.
- C₂: 82pF, 220pF, 10 μ F in parallel.

TYPICAL PERFORMANCE DATA

COLLECTOR DISSIPATION VS. CASE TEMPERATURE

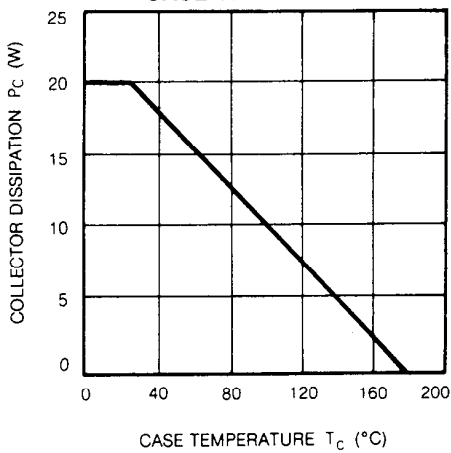

OUTPUT POWER, COLLECTOR EFFICIENCY VS. INPUT POWER

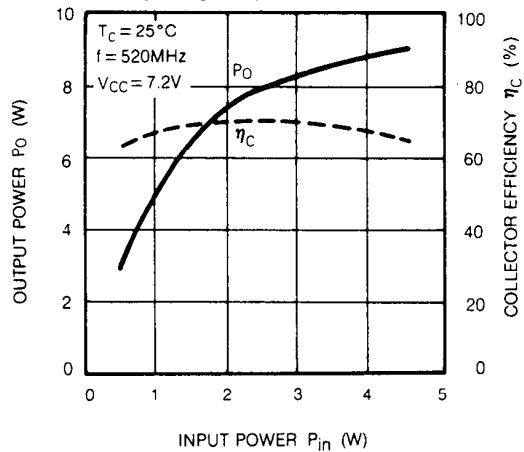

OUTPUT POWER VS. COLLECTOR SUPPLY VOLTAGE

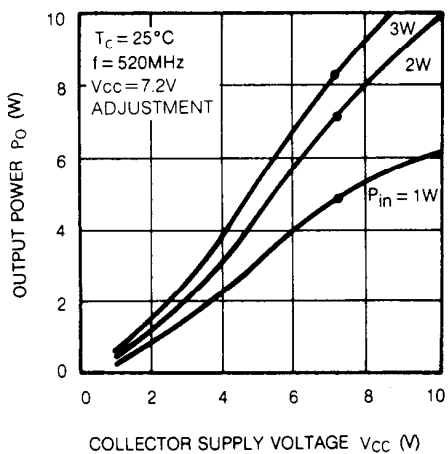

COLLECTOR OUTPUT CAPACITANCE VS. COLLECTOR TO BASE VOLTAGE

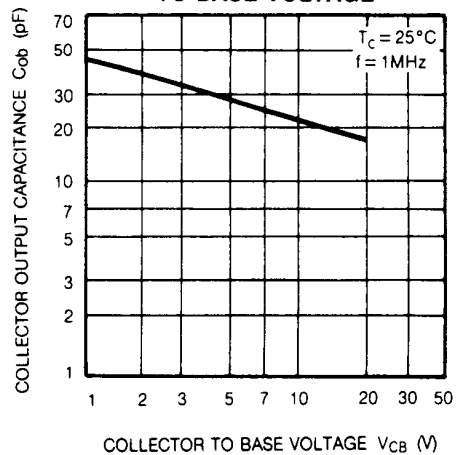

DC CURRENT GAIN VS. COLLECTOR CURRENT

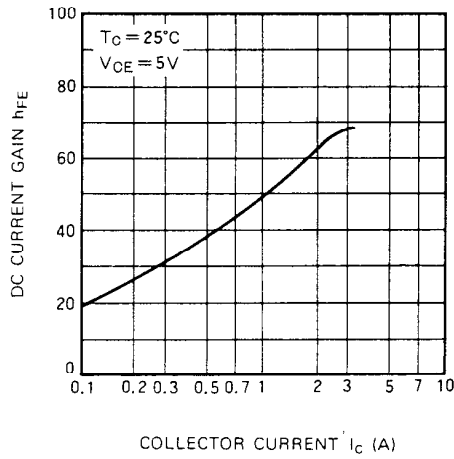

OUTPUT POWER VS. FREQUENCY

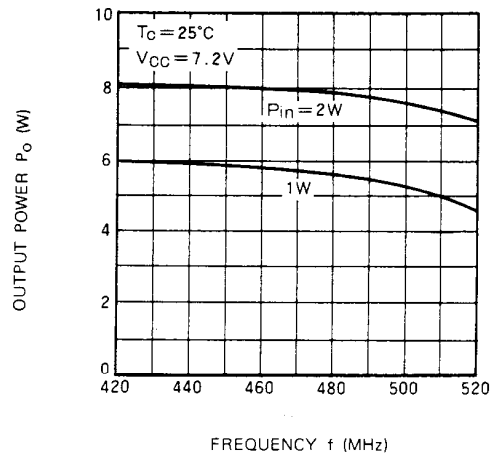

INPUT/OUTPUT IMPEDANCE

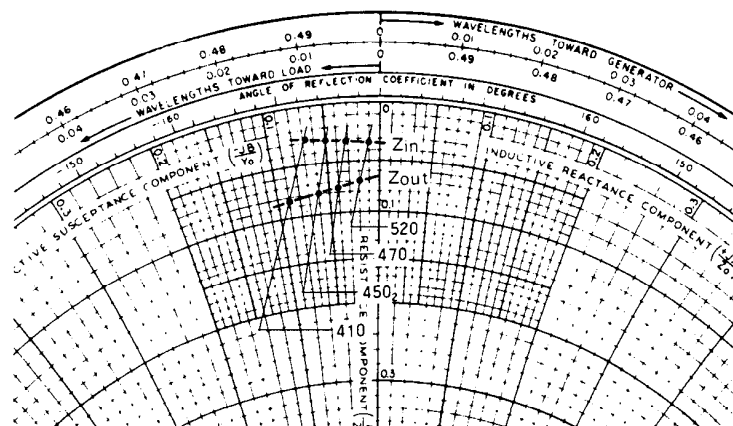

f (MHz)	$Z_{in}(\Omega)$	$Z_{ot}(\Omega)$
410	1.4-j3.0	4.0-j4.4
450	1.4-j2.2	3.8-j3.0
470	1.5-j1.5	3.6-j2.0
520	1.6-j0.4	3.5-j1.0

$V_{CC} = 7.2\text{V}$, $P_O = 6\text{W}$