

SANYO

No.978B

2SC3067NPN Epitaxial Planar Silicon Transistor
DIFFERENTIAL AMP APPLICATIONS**Features**

- . Excellent in thermal equilibrium and suited for use in first-stage differential amp.
- . Low noise.
- . Matched pair capability.

Absolute Maximum Ratings at $T_a=25^\circ\text{C}$

			unit
Collector to Base Voltage	V_{CBO}	130	V
Collector to Emitter Voltage	V_{CEO}	120	V
Emitter to Base Current	V_{EBO}	5	V
Collector Current	I_C	50	mA
Peak Collector Current	i_{cp}	100	mA
Collector Dissipation	P_C	200	mW
Total Dissipation	P_T	400	mW
Junction Temperature	T_J	150	$^\circ\text{C}$
Storage Temperature	T_{stg}	-55 to +150	$^\circ\text{C}$

Electrical Characteristics at $T_a=25^\circ\text{C}$

			min	typ	max	unit
Collector Cutoff Current	I_{CBO}	$V_{CB}=80\text{V}, I_E=0$			0.1	μA
Emitter Cutoff Current	I_{EBO}	$V_{EB}=4\text{V}, I_C=0$			0.1	μA
DC Current Gain	h_{FE}	$V_{CE}=6\text{V}, I_C=1\text{mA}$	160*		960*	
DC Current Gain Ratio	$h_{FE(\text{small/large})}$	$V_{CE}=6\text{V}, I_C=1\text{mA}$	0.85	0.98		
Base to Emitter Voltage Drop	$V_{BE(\text{large-small})}$	$V_{CE}=6\text{V}, I_C=1\text{mA}$		1.0	10	mV
Collector to Emitter Saturation Voltage	$V_{CE(\text{sat})}$	$I_C=10\text{mA}, I_B=1\text{mA}$			0.5	V
Gain-Bandwidth Product	f_T	$V_{CE}=6\text{V}, I_C=1\text{mA}$		130		MHz
Output Capacitance	c_{ob}	$V_{CB}=10\text{V}, f=1\text{MHz}$		1.6		pF

Continued on next page.

*: The 2SC3067 is classified by $h_{FE(\text{small})}$ as follows:

160	F	320	280	G	560	480	H	960
-----	---	-----	-----	---	-----	-----	---	-----

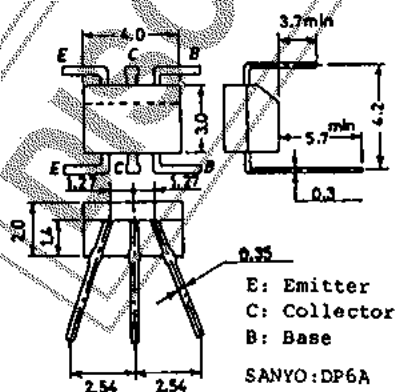
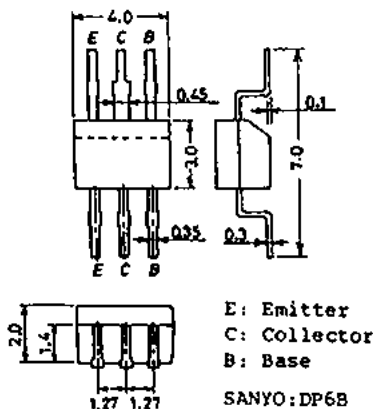
Case Outline 2029A
(unit:mm)**Case Outline 2030A**
(unit:mm)

The application circuit diagrams and circuit constants herein are included as an example and provide no guarantee for designing equipment to be mass-produced.

The information herein is believed to be accurate and reliable. However, no responsibility is assumed by SANYO for its use, nor for any infringements of patents or other rights of third parties which may result from its use.

Specifications and information herein are subject to change without notice.

SANYO Electric Co., Ltd. Semiconductor Overseas Marketing Div.

Nagatsuta Bldg., 1-3, G. 2, Shiba-oyama, Minami-Shinjyuku-ku, TOKYO 113, JAPAN

2145KI, TS No.978-1/3

Continued from preceding page.

			min	typ	max	unit
Collector to Base Breakdown Voltage	$V_{(BR)CBO}$	$I_C=10\mu A, I_E=0$	130			V
Collector to Emitter Breakdown Voltage	$V_{(BR)CEO}$	$I_C=1mA, R_{BE}=\infty$	120			V
Emitter to Base Breakdown Voltage	$V_{(BR)EBO}$	$I_E=10\mu A, I_C=0$	5			V
Noise Level	$V_{NO(ave)}$	$V_{CC}=30V, I_C=1mA, R_g=56k\Omega, V_G=77dB/1kHz$			35	mV
Noise Peak Level	$V_{NO(peak)}$	$V_{CC}=30V, I_C=1mA, R_g=56k\Omega, V_G=77dB/1kHz$			200	mV

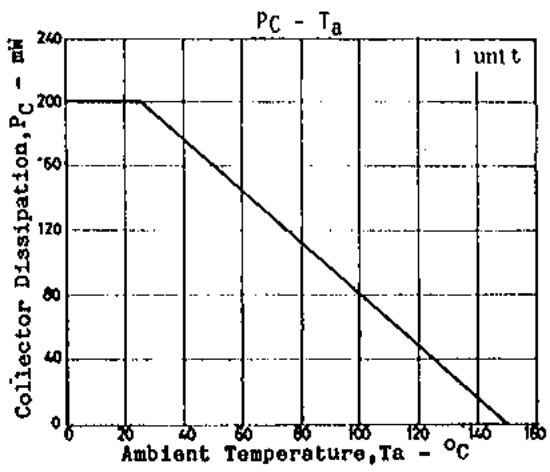
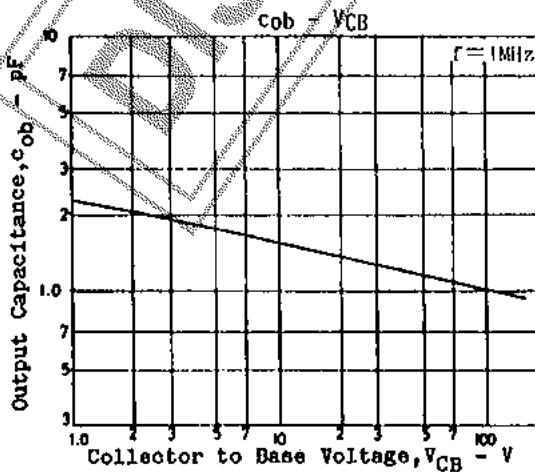
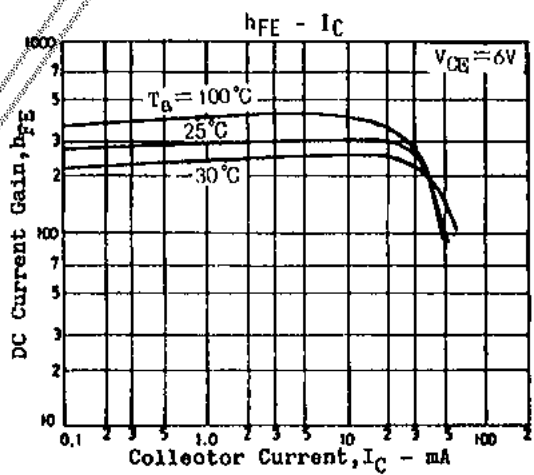
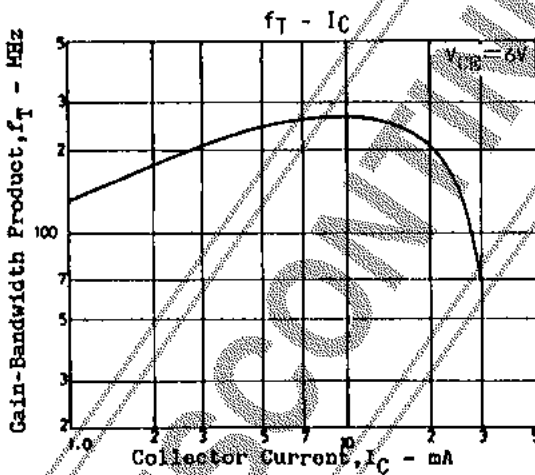
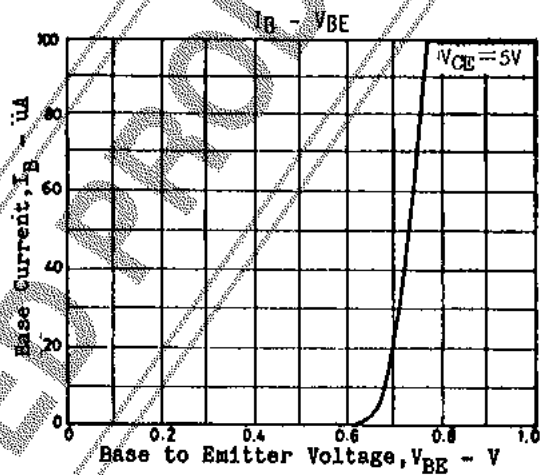
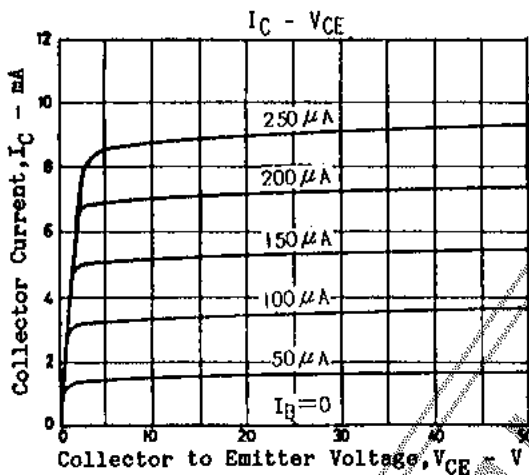

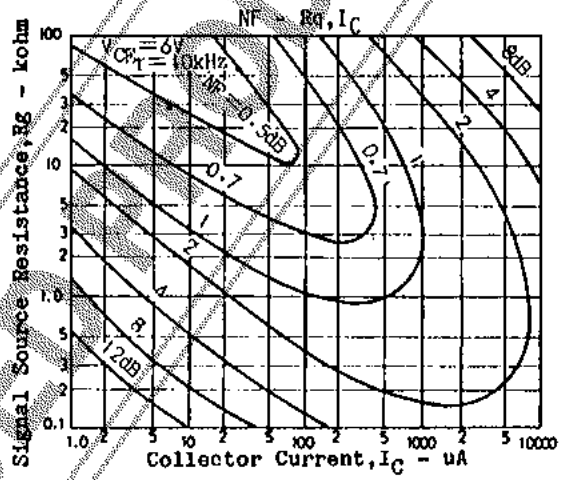
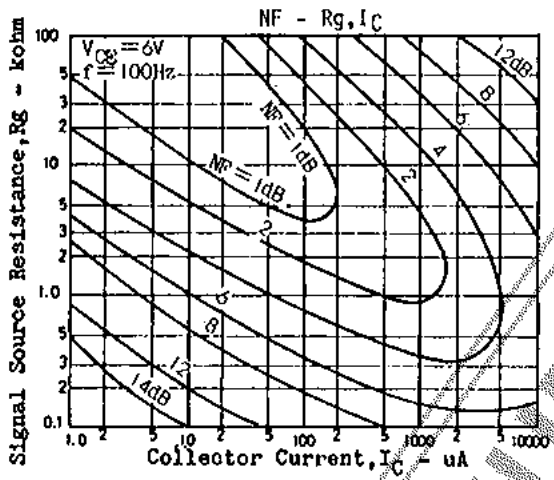
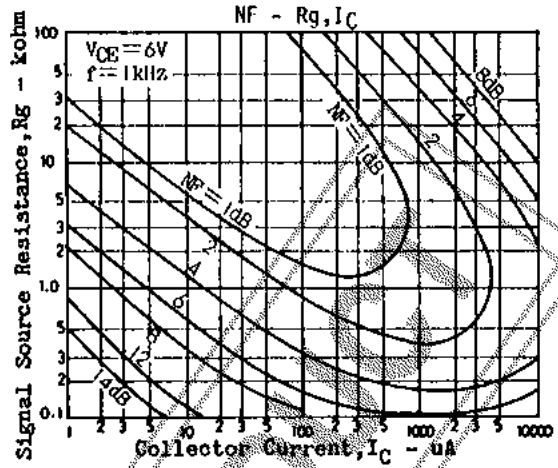
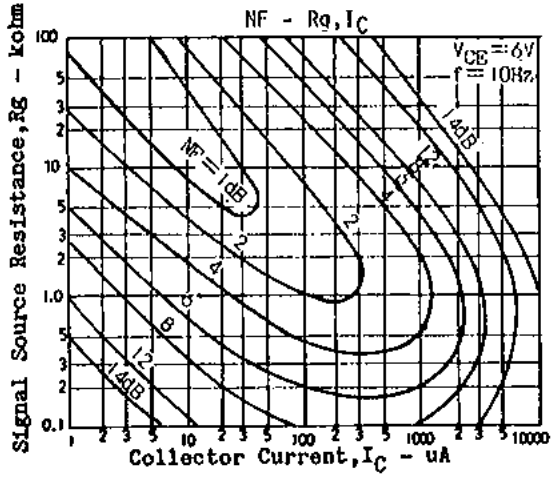

DISCONTINUED