

2SB968

Silicon PNP epitaxial planar type

For low-frequency output amplification

Complementary to 2SD1295

Features

- Possible to solder the radiation fin directly to printed circuit board
- High collector to emitter V_{CEO}
- Large collector power dissipation P_C

Absolute Maximum Ratings ($T_a=25^\circ\text{C}$)

Parameter	Symbol	Ratings	Unit
Collector to base voltage	V_{CBO}	-50	V
Collector to emitter voltage	V_{CEO}	-40	V
Emitter to base voltage	V_{EBO}	-5	V
Peak collector current	I_{CP}	-3	A
Collector current	I_C	-1.5	A
Collector power dissipation ($T_C=25^\circ\text{C}$)	P_C	20	W
Junction temperature	T_j	150	$^\circ\text{C}$
Storage temperature	T_{stg}	-55 to +150	$^\circ\text{C}$

Electrical Characteristics ($T_C=25^\circ\text{C}$)

Parameter	Symbol	Conditions	min	typ	max	Unit
Collector cutoff current	I_{CBO}	$V_{CB} = -20\text{V}, I_E = 0$			-1	μA
	I_{CEO}	$V_{CE} = -10\text{V}, I_B = 0$			-100	μA
Emitter cutoff current	I_{EBO}	$V_{EB} = -5\text{V}, I_C = 0$			-10	μA
Collector to base voltage	V_{CBO}	$I_C = -1\text{mA}, I_E = 0$	-50			V
Collector to emitter voltage	V_{CEO}	$I_C = -2\text{mA}, I_B = 0$	-40			V
Forward current transfer ratio	h_{FE}^*	$V_{CE} = -5\text{V}, I_C = -1\text{A}$	50		220	
Collector to emitter saturation voltage	$V_{CE(sat)}$	$I_C = -1.5\text{A}, I_B = -0.15\text{A}$			-1	V
Base to emitter saturation voltage	$V_{BE(sat)}$	$I_C = -2\text{A}, I_B = -0.2\text{A}$			-1.5	V
Transition frequency	f_T	$V_{CB} = -5\text{V}, I_E = 0.5\text{A}, f = 200\text{MHz}$		150		MHz
Collector output capacitance	C_{ob}	$V_{CB} = -20\text{V}, I_E = 0, f = 1\text{MHz}$		45		pF

* h_{FE} Rank classification

Rank	P	Q	R
h_{FE}	50 to 100	80 to 160	120 to 220

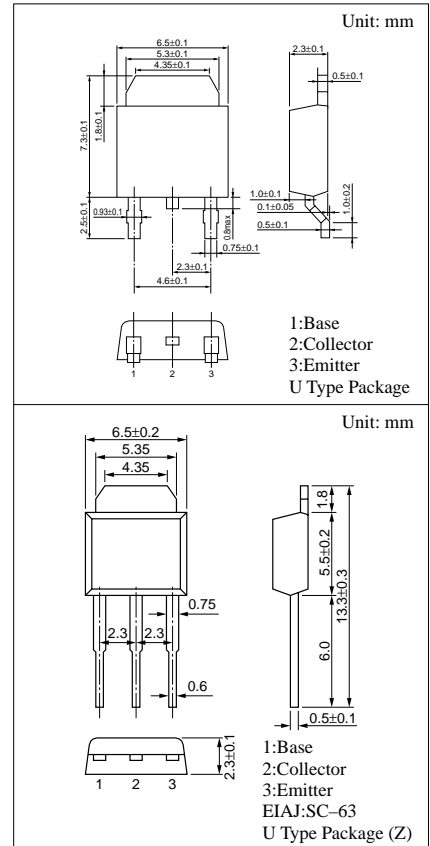

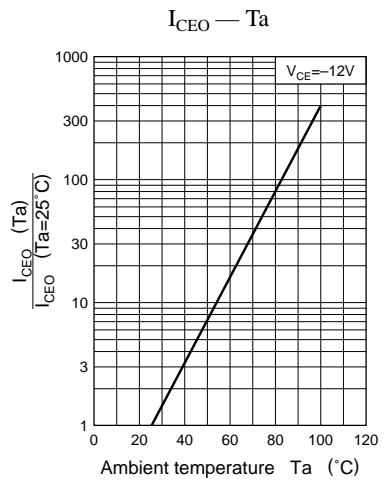
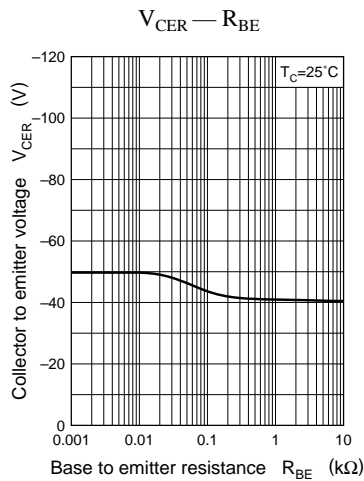
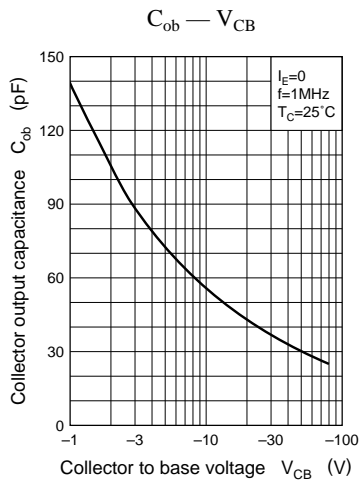
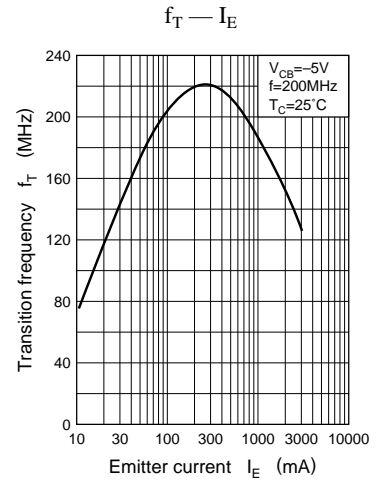
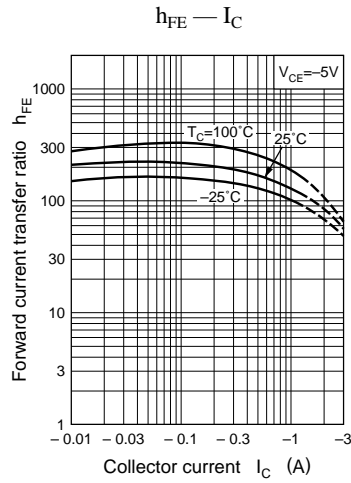
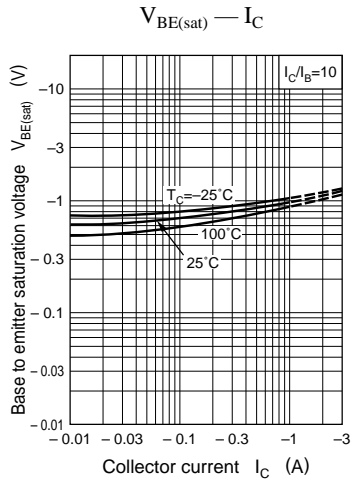
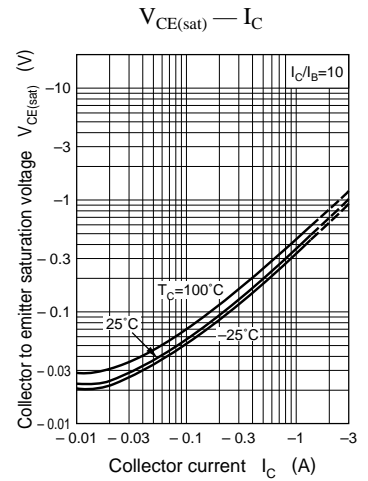
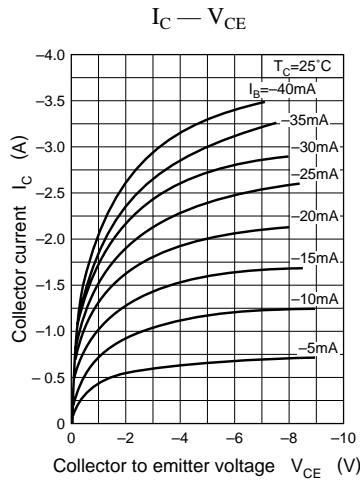
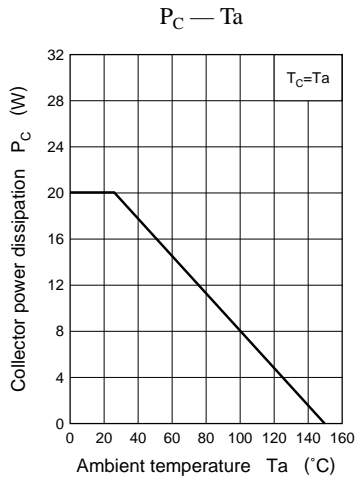

Area of safe operation (ASO)

