

# 2SB967

## Silicon PNP epitaxial planar type

For low-frequency power amplification

### Features

- Possible to solder the radiation fin directly to printed circuit board
- Low collector to emitter saturation voltage  $V_{CE(sat)}$
- Large collector current  $I_C$

### Absolute Maximum Ratings ( $T_a=25^\circ\text{C}$ )

Parameter	Symbol	Rated	Unit
Collector to base voltage	$V_{CBO}$	-27	V
Collector to emitter voltage	$V_{CEO}$	-18	V
Emitter to base voltage	$V_{EBO}$	-7	V
Peak collector current	$I_{CP}$	-8	A
Collector current	$I_C$	-5	A
Collector power dissipation ( $T_C=25^\circ\text{C}$ )	$P_C$	20	W
Junction temperature	$T_j$	150	$^\circ\text{C}$
Storage temperature	$T_{stg}$	-55 to +150	$^\circ\text{C}$

### Electrical Characteristics ( $T_C=25^\circ\text{C}$ )

Parameter	Symbol	Conditions	min	typ	max	Unit
Collector cutoff current	$I_{CBO}$	$V_{CB} = -10\text{V}, I_E = 0$			-100	nA
Emitter cutoff current	$I_{EBO}$	$V_{EB} = -5\text{V}, I_C = 0$			-1	$\mu\text{A}$
Collector to emitter voltage	$V_{CEO}$	$I_C = -1\text{mA}, I_B = 0$	-18			V
Emitter to base voltage	$V_{EBO}$	$I_E = -10\mu\text{A}, I_C = 0$	-7			V
Forward current transfer ratio	$h_{FE}^*$	$V_{CE} = -2\text{V}, I_C = -2\text{A}$	90		625	
Collector to emitter saturation voltage	$V_{CE(sat)}$	$I_C = -3\text{A}, I_B = -0.1\text{A}$			-1	V
Transition frequency	$f_T$	$V_{CB} = -6\text{V}, I_E = 50\text{mA}, f = 200\text{MHz}$		120		MHz
Collector output capacitance	$C_{ob}$	$V_{CB} = -20\text{V}, I_E = 0, f = 1\text{MHz}$			85	pF

\* $h_{FE}$  Rank classification

Rank	P	Q	R
$h_{FE}$	90 to 135	125 to 205	180 to 625

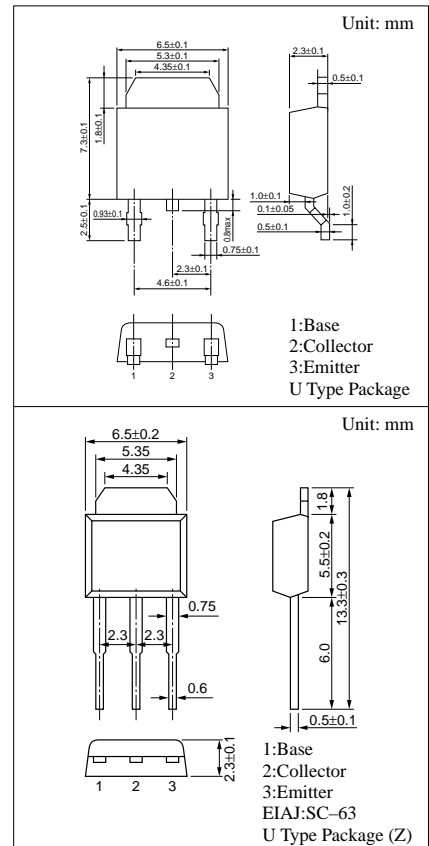

$P_C - T_a$

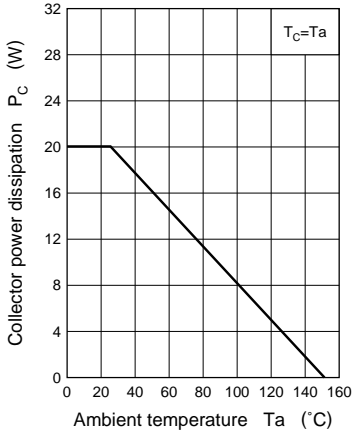

$I_C - V_{CE}$

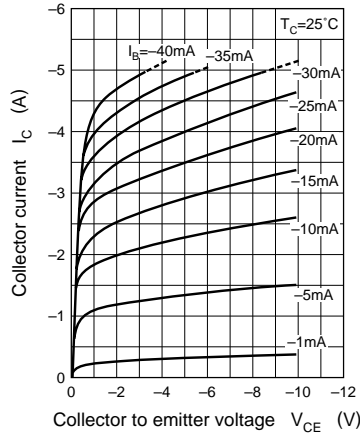

$I_C - V_{BE}$

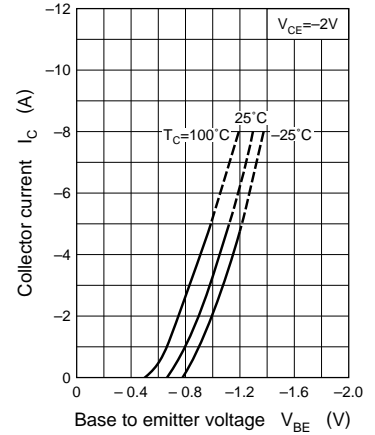

$V_{CE(sat)} - I_C$

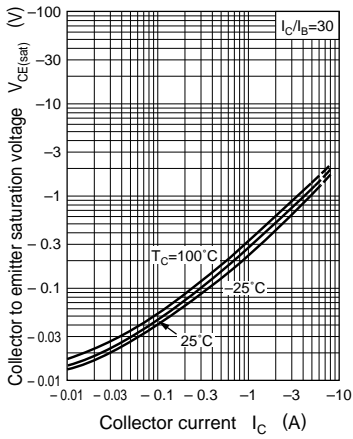

$h_{FE} - I_C$

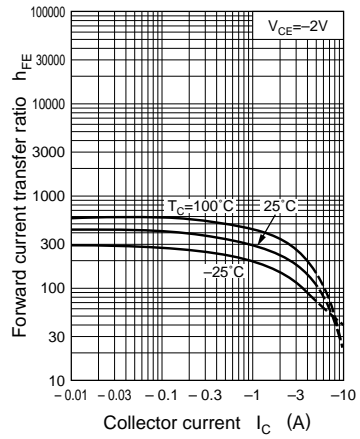

$f_T - I_E$

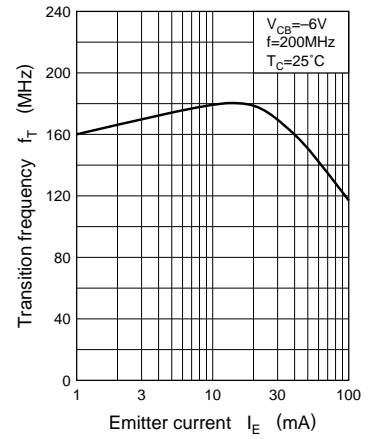

$C_{ob} - V_{CB}$

