

2SB1629

Silicon PNP epitaxial planar type

For power amplification

Features

- High forward current transfer ratio h_{FE}
- Satisfactory linearity of forward current transfer ratio h_{FE}
- Full-pack package with outstanding insulation, which can be installed to the heat sink with one screw

Absolute Maximum Ratings ($T_C=25^\circ\text{C}$)

Parameter	Symbol	Rated	Unit
Collector to base voltage	V_{CBO}	-60	V
Collector to emitter voltage	V_{CEO}	-60	V
Emitter to base voltage	V_{EBO}	-6	V
Peak collector current	I_{CP}	-6	A
Collector current	I_C	-3	A
Base current	I_B	-1	A
Collector power dissipation	P_C	40	W
		2	W
Junction temperature	T_j	150	$^\circ\text{C}$
Storage temperature	T_{stg}	-55 to +150	$^\circ\text{C}$

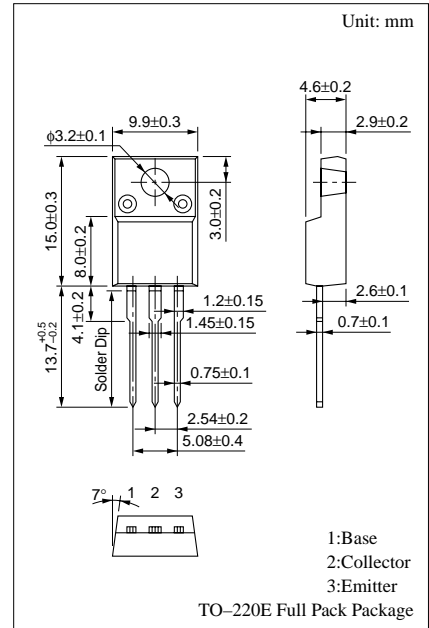

Electrical Characteristics ($T_C=25^\circ\text{C}$)

Parameter	Symbol	Conditions	min	typ	max	Unit
Collector cutoff current	I_{CBO}	$V_{CB} = -60\text{V}, I_E = 0$			-100	μA
	I_{CEO}	$V_{EB} = -40\text{V}, I_B = 0$			-100	μA
Emitter cutoff current	I_{EBO}	$V_{EB} = -6\text{V}, I_C = 0$			-100	μA
Collector to emitter voltage	V_{CEO}	$I_C = -25\text{mA}, I_B = 0$	-60			V
Forward current transfer ratio	h_{FE}^*	$V_{CE} = -4\text{V}, I_C = -0.5\text{A}$	300		700	
Collector to emitter saturation voltage	$V_{CE(sat)}$	$I_C = -2\text{A}, I_B = -0.05\text{A}$			-1	V
Transition frequency	f_T	$V_{CE} = -12\text{V}, I_C = -0.2\text{A}, f = 10\text{MHz}$		30		MHz

* h_{FE} Rank classification

Rank	Q	P
h_{FE}	300 to 500	400 to 700

$P_C - T_a$

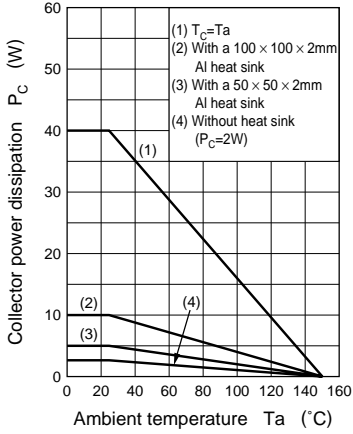

$I_C - V_{CE}$

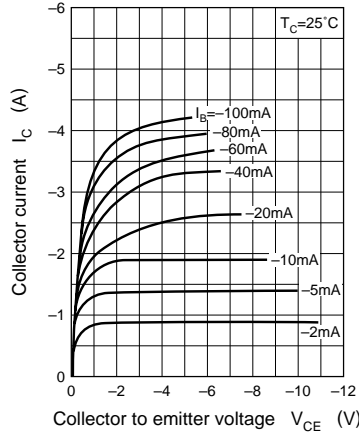

$I_C - V_{BE}$

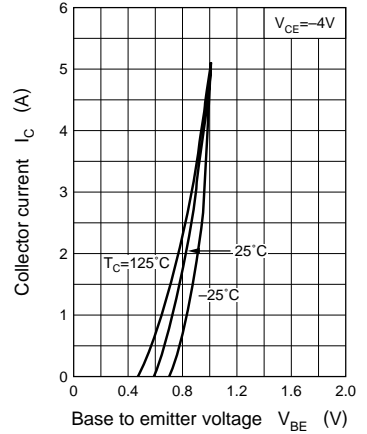

$V_{CE(sat)} - I_C$

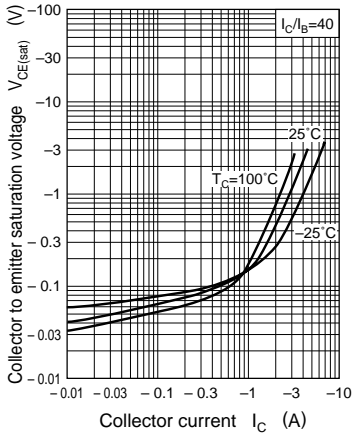

$h_{FE} - I_C$

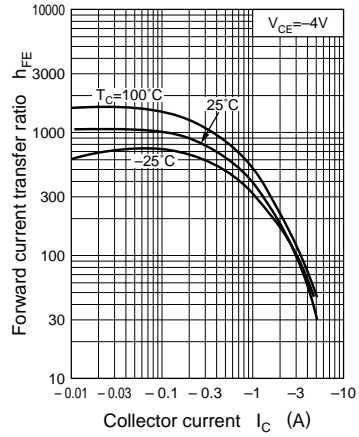

$f_T - I_C$

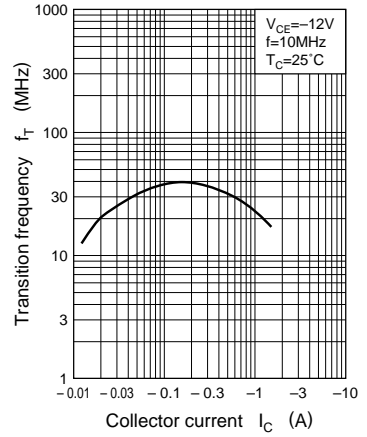

$C_{ob} - V_{CB}$

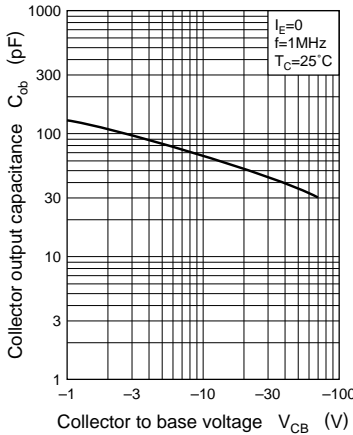

$t_{on}, t_{stg}, t_f - I_C$

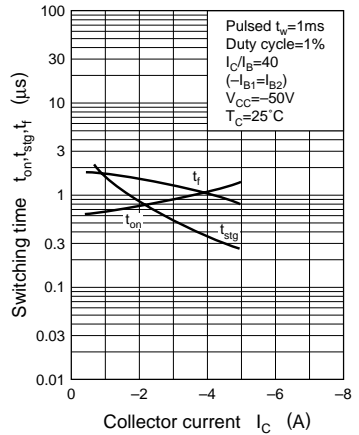

Area of safe operation (ASO)

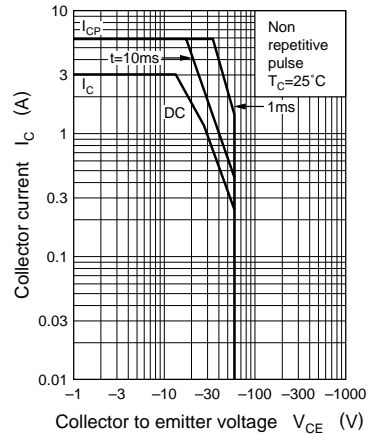

$$R_{th(t)} - t$$

