

Darlington

2SB1588

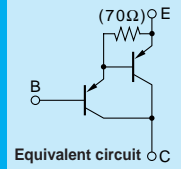

Silicon PNP Epitaxial Planar Transistor (Complement to type 2SD2439)

Application : Audio, Series Regulator and General Purpose

Absolute maximum ratings (Ta=25°C)

| Symbol | 2SB1588 | Unit |
|------------------|-------------|------|
| V _{CB0} | -160 | V |
| V _{CEO} | -150 | V |
| V _{EBO} | -5 | V |
| I _c | -10 | A |
| I _B | -1 | A |
| P _c | 80(Tc=25°C) | W |
| T _J | 150 | °C |
| T _{stg} | -55 to +150 | °C |

Electrical Characteristics (Ta=25°C)

| Symbol | Conditions | 2SB1588 | Unit |
|----------------------|---|----------|------|
| I _{CB0} | V _{CB} =-160V | -100max | μA |
| I _{EBO} | V _{EB} =-5V | -100max | μA |
| V _{(BR)CEO} | I _c =-30mA | -150min | V |
| h _{FE} | V _{CE} =-4V, I _c =-7A | 5000min* | |
| V _{CE(sat)} | I _c =-7A, I _B =-7mA | -2.5max | V |
| V _{BE(sat)} | I _c =-7A, I _B =-7mA | -3.0max | V |
| f _r | V _{CE} =-12V, I _E =2A | 50typ | MHz |
| C _{OB} | V _{CB} =-10V, f=1MHz | 230typ | pF |

*h_{FE} Rank ○(5000 to 12000), P(6500 to 20000), Y(15000 to 30000)

External Dimensions FM100(TO3PF)

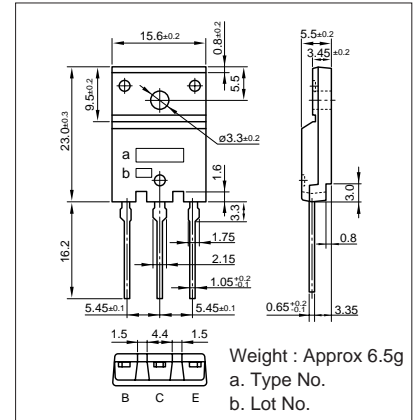

Weight : Approx 6.5g
a. Type No.
b. Lot No.

Typical Switching Characteristics (Common Emitter)

| V _{CC} (V) | R _L (Ω) | I _c (A) | V _{BB1} (V) | V _{BB2} (V) | I _{B1} (mA) | I _{B2} (mA) | t _{on} (μs) | t _{stg} (μs) | t _f (μs) |
|---------------------|--------------------|--------------------|----------------------|----------------------|----------------------|----------------------|----------------------|-----------------------|---------------------|
| -70 | 10 | -7 | -10 | 5 | -7 | 7 | 0.8typ | 3.0typ | 1.2typ |

I_c-V_{CE} Characteristics (Typical)

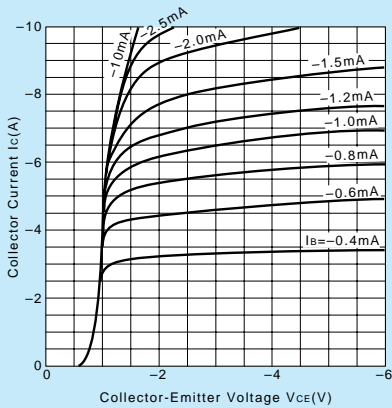

V_{CE(sat)}-I_B Characteristics (Typical)

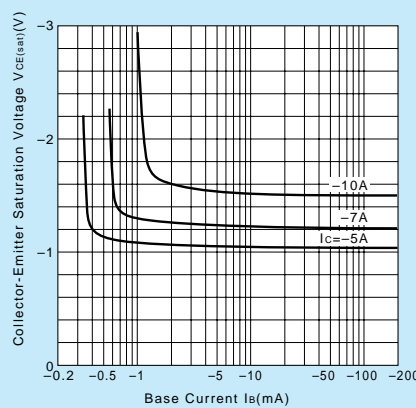

I_c-V_{BE} Temperature Characteristics (Typical)

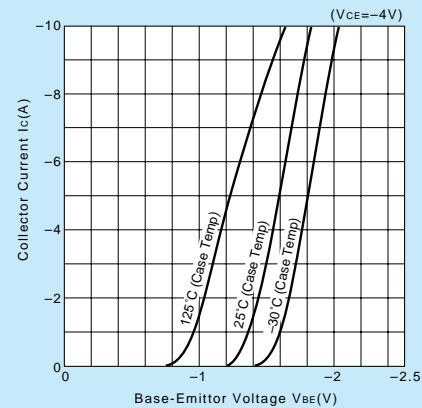

h_{FE}-I_c Characteristics (Typical)

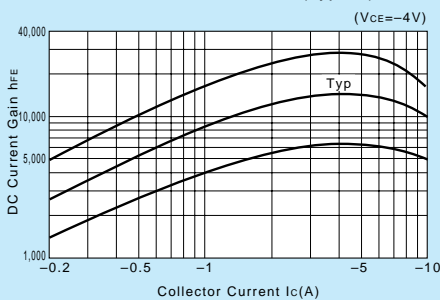

h_{FE}-I_c Temperature Characteristics (Typical)

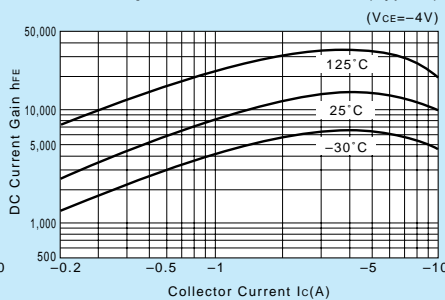

θ_{j-a}-t Characteristics

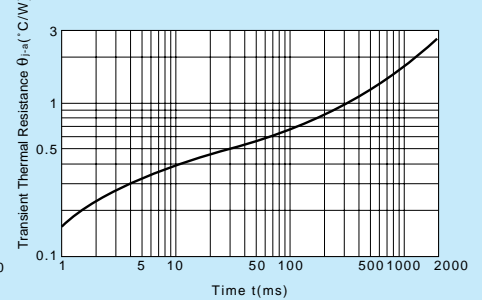

f_T-I_E Characteristics (Typical)

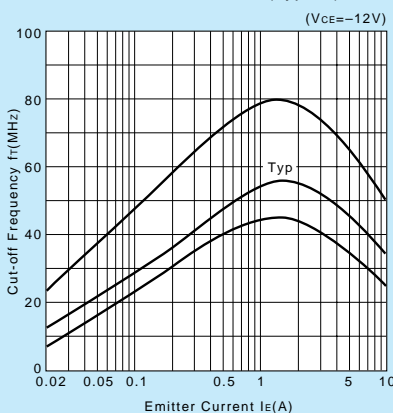

Safe Operating Area (Single Pulse)

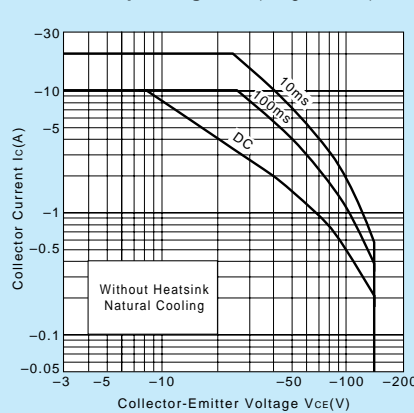

P_c-T_a Derating

