

SHINDENGEN

Darlington Transistor

2SB1448
(TP15J10)

-15A PNP

OUTLINE DIMENSIONS

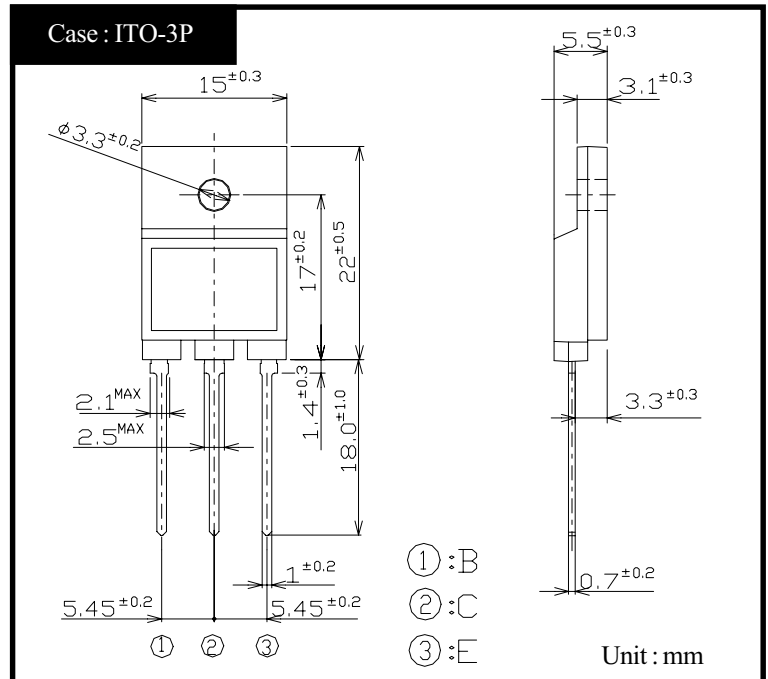

RATINGS

● Absolute Maximum Ratings

Item	Symbol	Conditions	Ratings	Unit
Storage Temperature	T_{stg}		-55~+150	°C
Junction Temperature	T_j		+150	°C
Collector to Base Voltage	V_{CBO}		-100	V
Collector to Emitter Voltage	V_{CEO}		-100	V
Emitter to Base Voltage	V_{EBO}		-7	V
Collector Current DC	I_C		-15	A
Collector Current Peak	I_{CP}		-22	A
Base Current DC	I_B		-1	A
Base Current Peak	I_{BP}		-2	A
Total Transistor Dissipation	P_T	$T_C = 25^\circ C$	65	W
Dielectric Strength	V_{dis}	Terminals to case AC 1 minute	2	kV
Mounting Torque	TOR	(Recommended torque : 0.5N·m)	0.8	N·m

● Electrical Characteristics ($T_C=25^\circ C$)

Item	Symbol	Conditions	Ratings	Unit
Collector Cutoff Current	I_{CBO}	$V_{CB} = -100V$	Max -0.1	mA
	I_{CEO}	$V_{CE} = -100V$	Max -0.1	
Emitter Cutoff Current	I_{EBO}	$V_{EB} = -7V$	Max -5	mA
DC Current Gain	h_{FE}	$V_{CE} = -3V, I_C = -10A$	Min 1,500	
			Max 15,000	
Collector to Emitter Saturation Voltage	$V_{CE(sat)}$	$I_C = -10A$	Max -1.5	V
Base to Emitter Saturation Voltage	$V_{BE(sat)}$	$I_B = -20mA$	Max -2.0	V
Thermal Resistance	θ_{jc}	Junction to case	Max 1.92	°C/W
Transition Frequency	f_T	$V_{CE} = -10V, I_C = -1.5A$	TYP 20	MHz
Turn on Time	t_{on}		Max 1	μs
Storage Time	t_s	$I_C = -15A$ $I_{B1} = I_{B2} = -20mA$ $R_L = 2\Omega$	Max 4	
Fall Time	t_f	$V_{BB2} = -4V$	Max 2	

2SB1448

$h_{FE} - I_C$

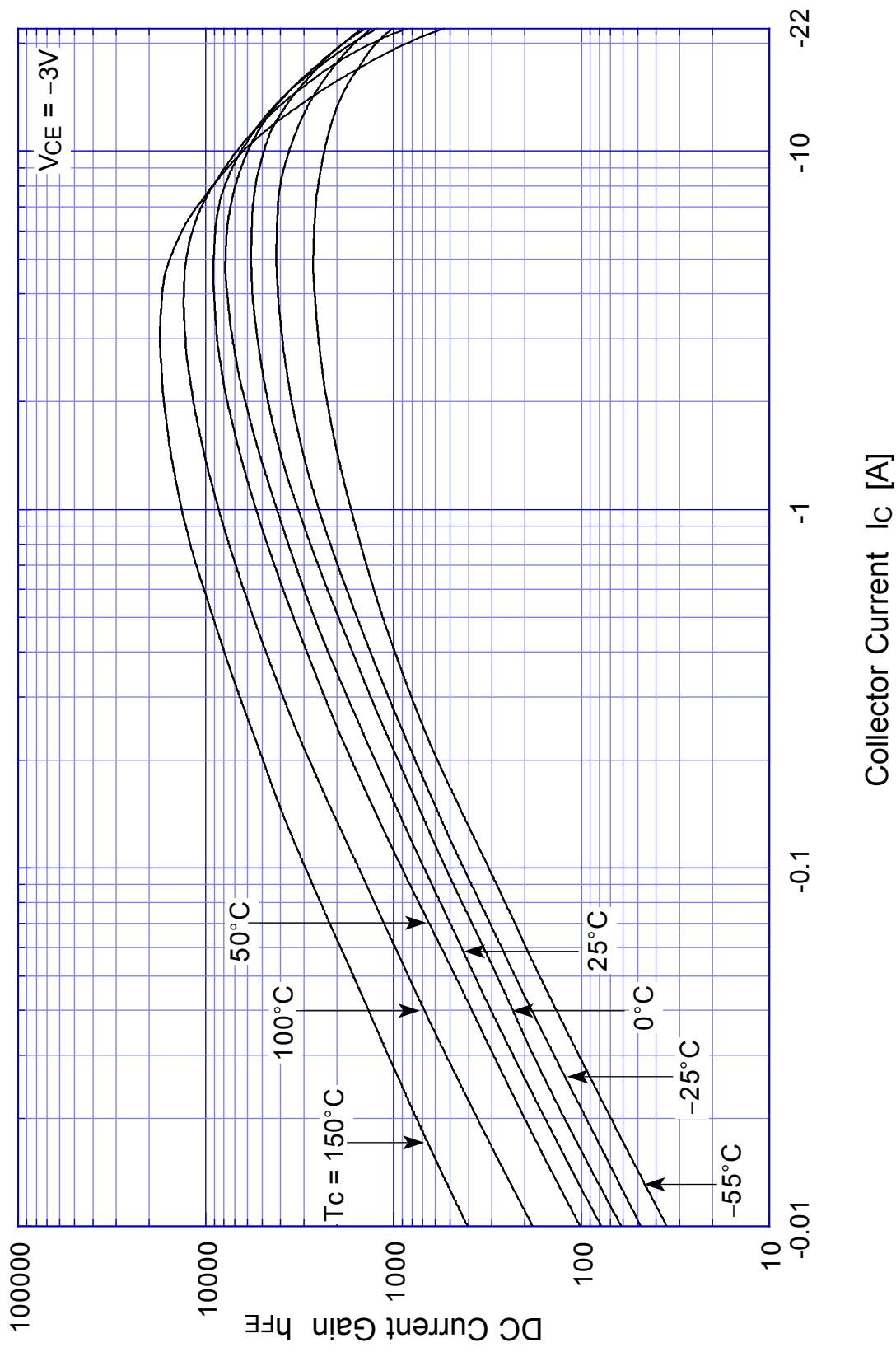

2SB1448 Saturation Voltage

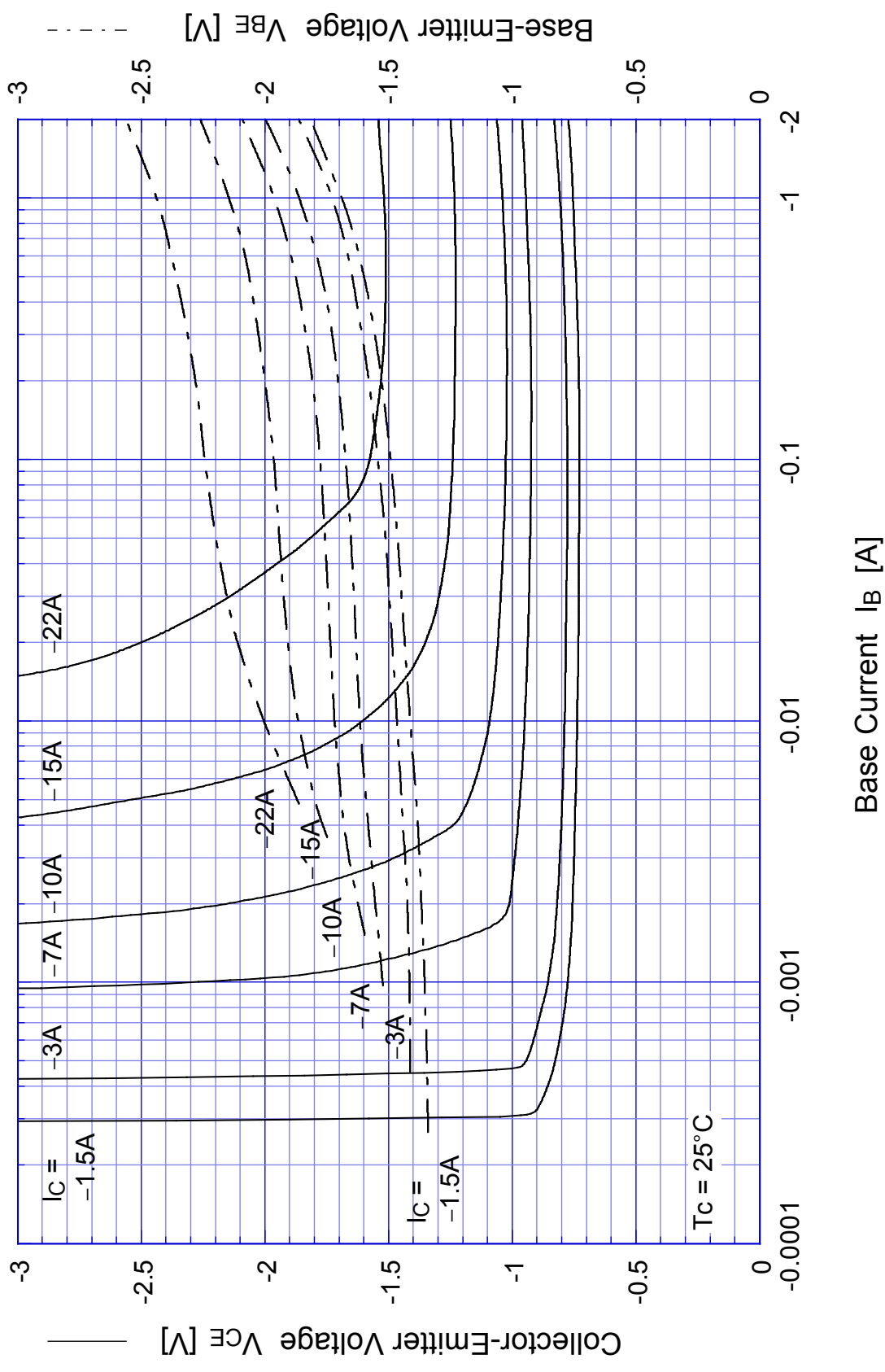

2SB1448

Switching Time - I_C

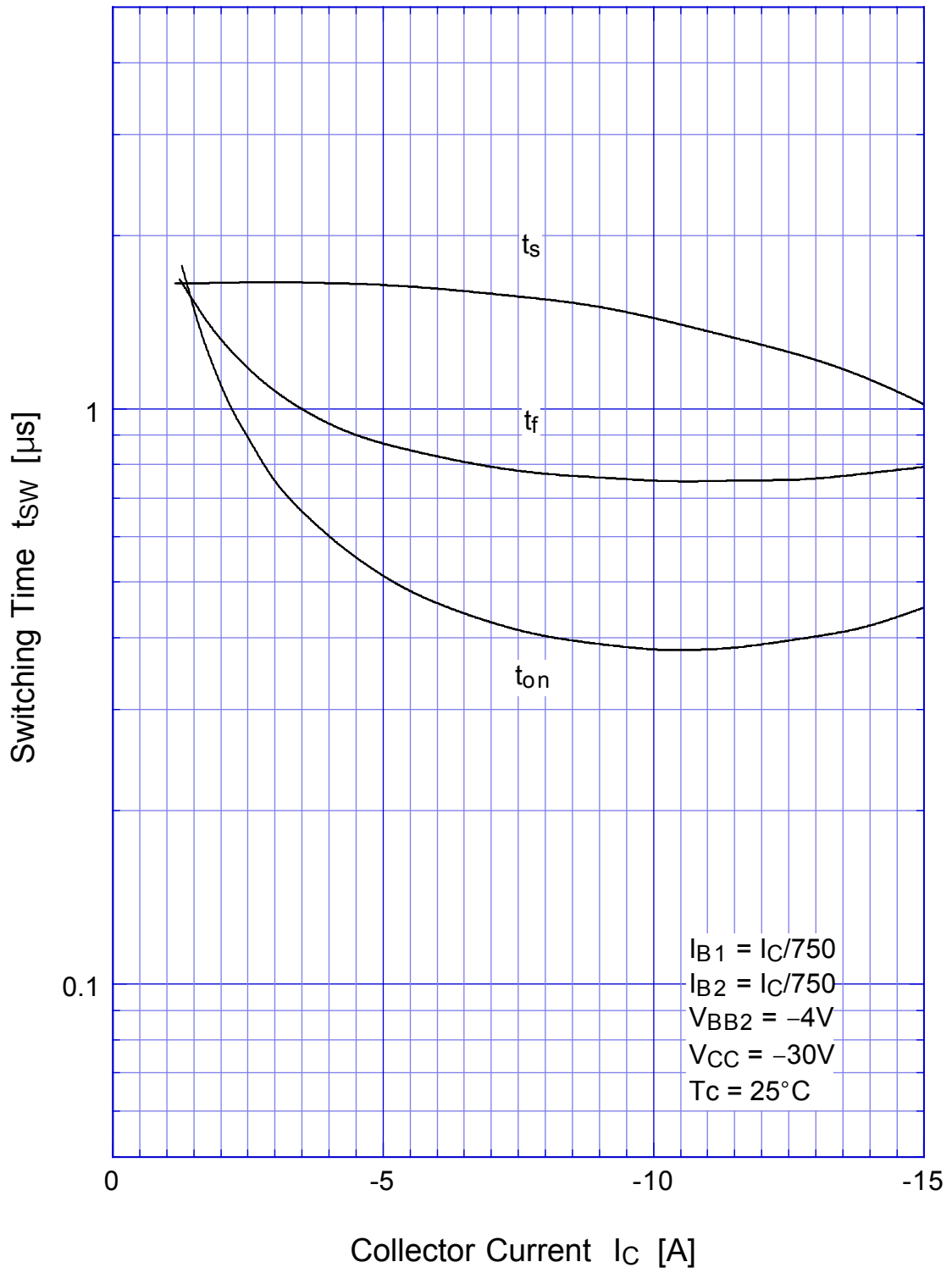

2SB1448

Switching Time - Tc

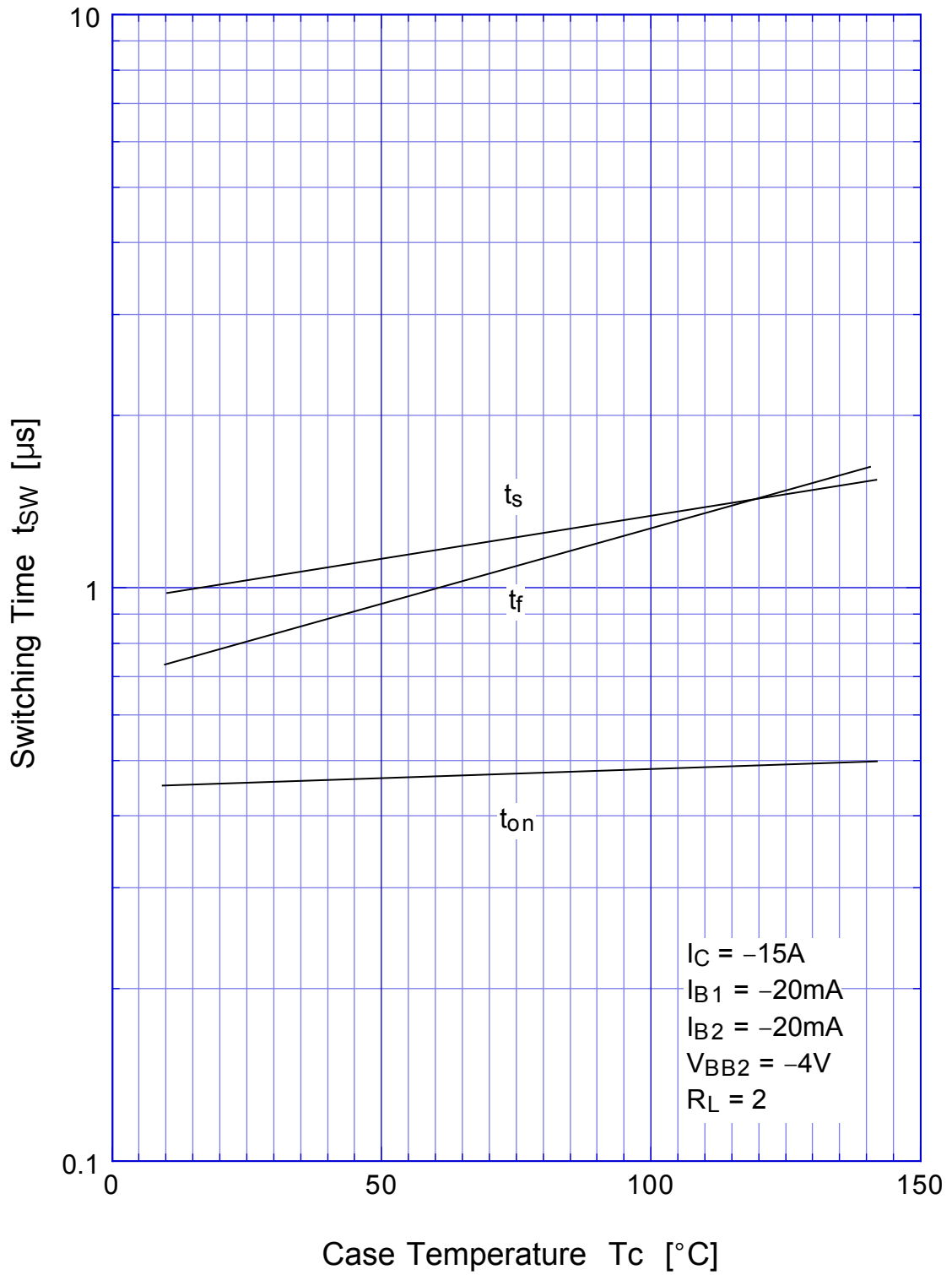

2SB1448 Transient Thermal Impedance

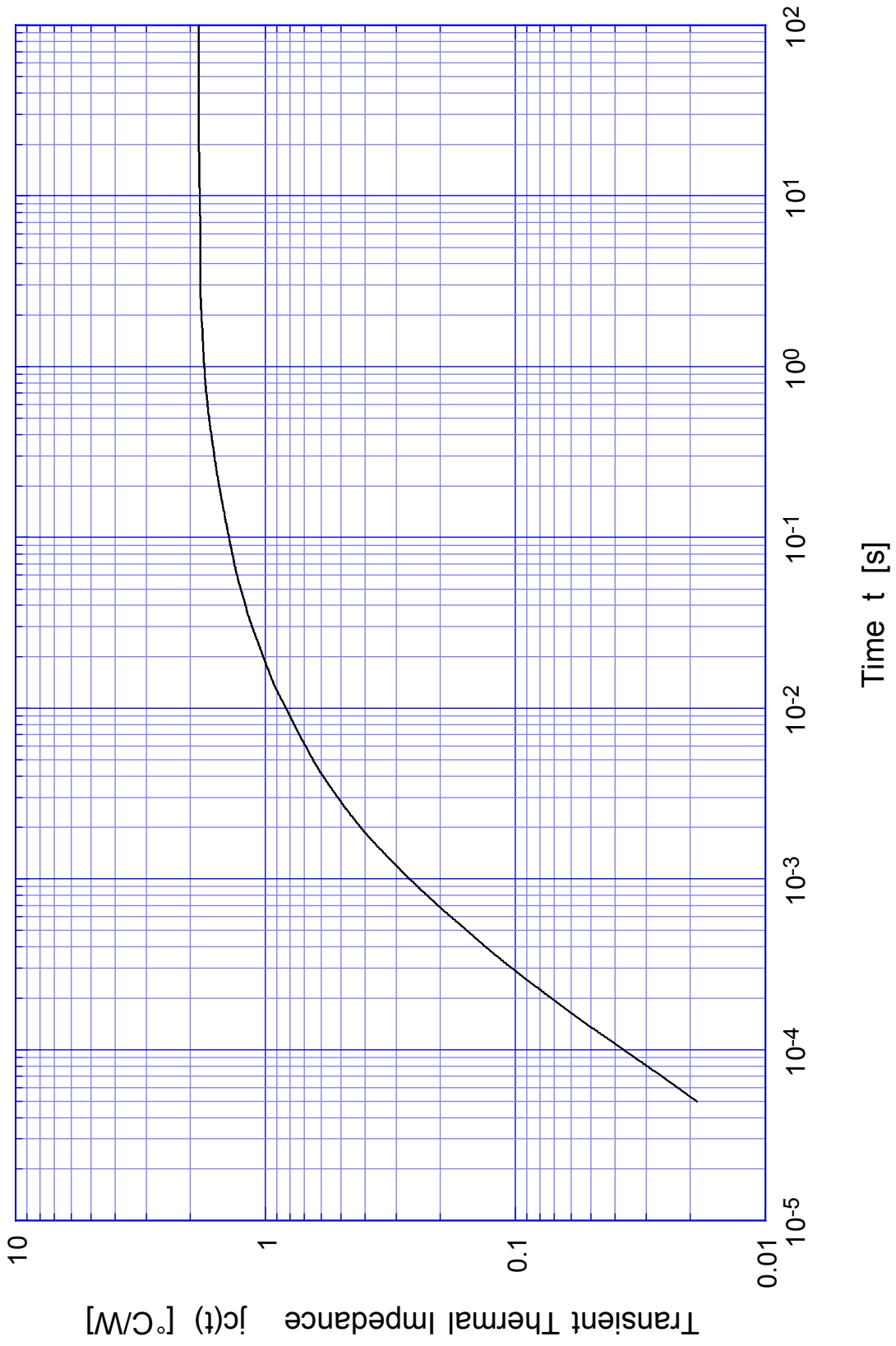

2SB1448

Forward Bias SOA

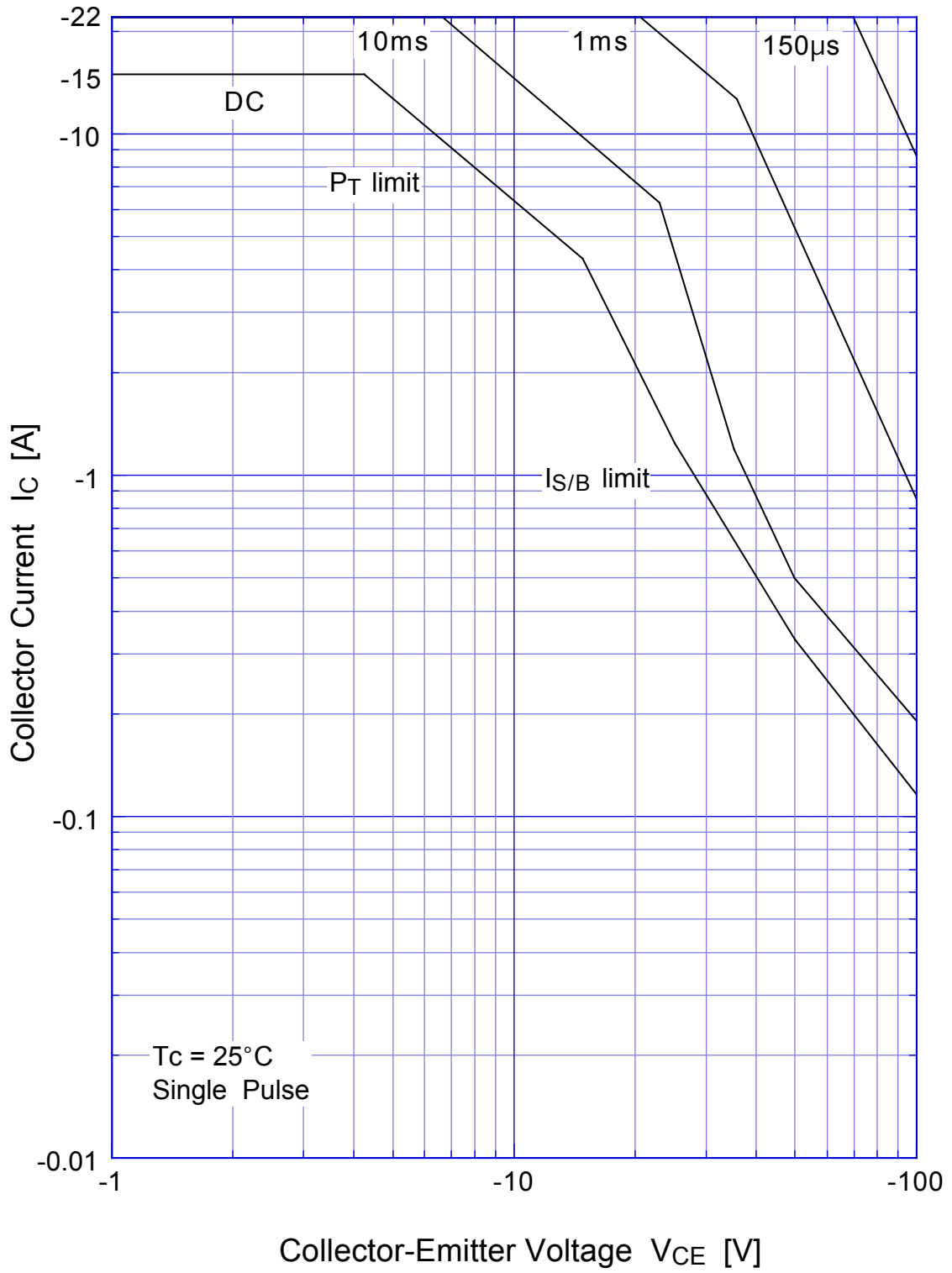

2SB1448 Collector Current Derating



2SB1448

Reverse Bias SOA

