

**FOR LOW FREQUENCY POWER AMPLIFY APPLICATION
SILICON PNP EPITAXIAL PLANAR TYPE**

DESCRIPTION

Mitsubishi 2SB1314 is a silicon PNP epitaxial planar type power transistor using insulated full mold package.

FEATURE

- High collector current $I_C = -3A, I_{CM} = -5A$
- High h_{FE} $h_{FE} = 150$ to 500
- Full mold package with heat sink
- High voltage $V_{CEO} = -60V$
- Low collector to emitter saturation voltage
 $V_{CE(sat)} = -0.5V$ max (@ $I_C = -2A, I_B = -0.2A$)

APPLICATION

Power supply circuit, solenoid drive.

OUTLINE DRAWING

Unit:mm

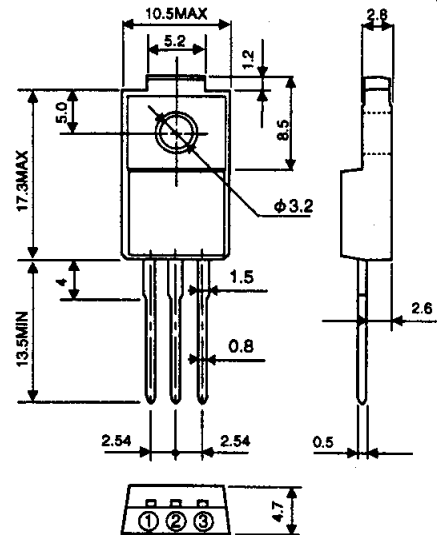

TERMINAL CONNECTOR

- ① : BASE
 - ② : COLLECTOR
 - ③ : EMITTER
- EIAJ : —
JEDEC : —

Note)
The dimension without tolerance represent central value.

MAXIMUM RATINGS (Ta=25°C)

Symbol	Parameter	Ratings	Unit	
V _{CB0}	Collector to Base voltage	-60	V	
V _{EB0}	Emitter to Base voltage	-7	V	
V _{CEO}	Collector to Emitter voltage	-60	V	
I _{CM}	Peak collector current	-5	A	
I _C	Collector current	-3	A	
P _C	Collector dissipation	(Ta=25°C)	2	W
		(Tc=25°C)	15	W
T _J	Junction temperature	+150	°C	
T _{stg}	Storage temperature	-55 to +150	°C	

ELECTRICAL CHARACTERISTICS (Ta=25°C)

Symbol	Parameter	Test conditions	Limits			Unit
			Min	Typ	Max	
V _{(BR)CBO}	C to B break down voltage	I _C = -100 μA	-60			V
V _{(BR)EBO}	E to B break down voltage	I _E = -100 μA, I _C = 0	-7			V
V _{(BR)CEO}	C to E break down voltage	I _C = -1mA, R _{BE} = ∞	-60			V
I _{CB0}	Collector cut off current	V _{CB} = -50V, I _E = 0			-1	μA
I _{EB0}	Emitter cut off current	V _{EB} = -6V, I _C = 0			-1	μA
h _{FE} *	DC forward current gain	V _{CE} = -5V, I _C = 500mA	150		500	—
V _{CE(sat)}	C to E saturation voltage	I _C = -2A, I _B = -0.2A			-0.5	V
ft	Gain band width product	V _{CE} = -6V, I _E = 10mA		100		MHZ

* : It shows h_{FE} classification in right table.

Item	E	F
h _{FE}	150 to 300	250 to 500

**FOR LOW FREQUENCY POWER AMPLIFY APPLICATION
SILICON PNP EPITAXIAL PLANAR TYPE**

TYPICAL CHARACTERISTICS

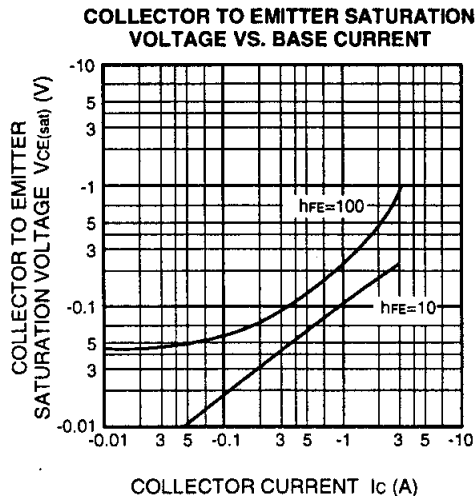
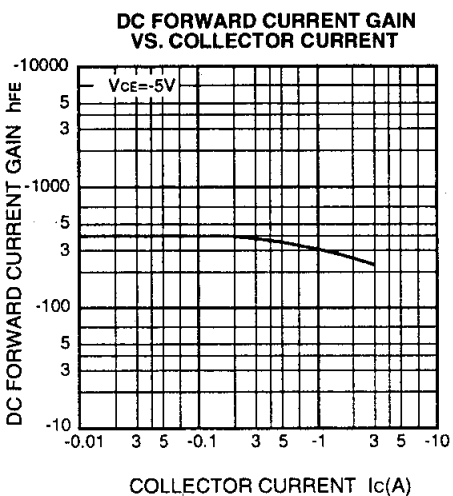
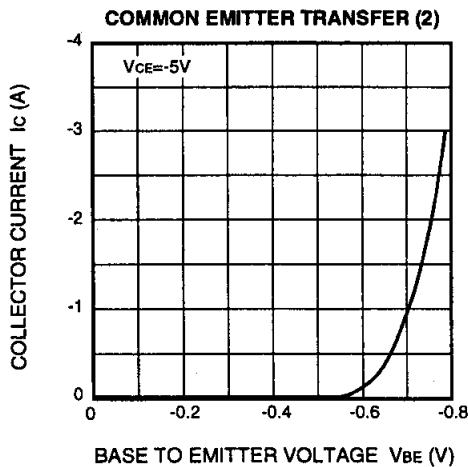
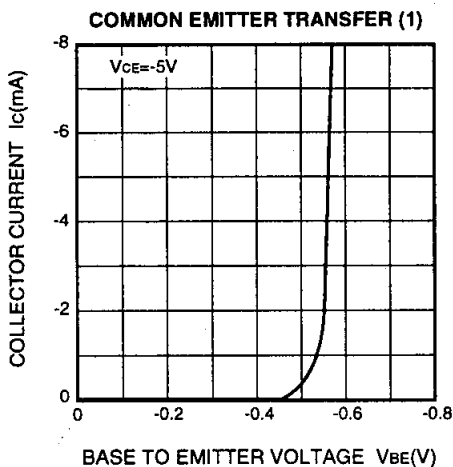
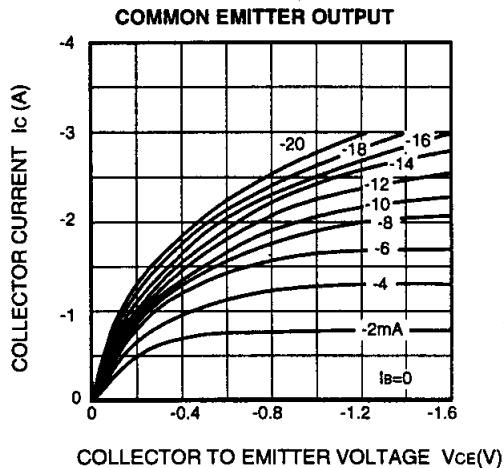
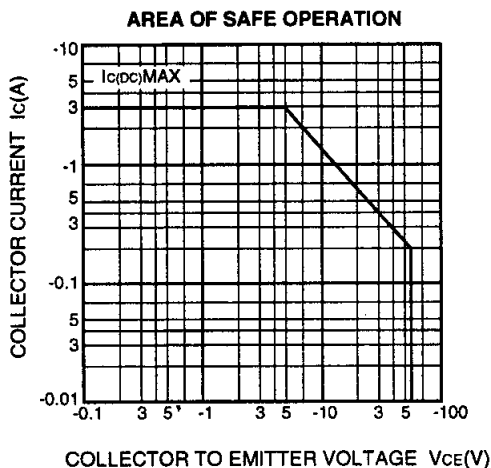

The logo for IDC ISAHAYA ELECTRONICS CORPORATION. It features the letters 'IDC' in a stylized blue font with a red triangle above the 'I'. To the right of 'IDC', the words 'ISAHAYA ELECTRONICS CORPORATION' are written in a black, italicized, serif font.

<http://www.idc-com.co.jp>
6-41, TSUKUBA, ISAHAYA, NAGASAKI, 854-0065, JAPAN

Keep safety in your circuit designs !

Isahaya Electronics Corporation puts the maximum effort into making semiconductor products better and more reliable, but there is always the possibility that trouble may occur with them. Trouble with semiconductors may lead to personal injury, fire or property damage. Remember to give consideration to safety when making your circuit designs, with appropriate measures such as (i) placement of substitutive, auxiliary circuits, (ii) use of non-flammable material or (iii) prevention against any malfunction or mishap.

Notes regarding these materials

·These materials are intended as reference to assist out customers in the selection of the Isahaya semiconductor product best suited to the customer's application, they do not convey any license under any intellectual property rights, or any other rights, belonging to Isahaya Electronics Corporation or a third party.
·Isahaya Electronics Corporation assumes no responsibility for any damage, or infringement of any third-party rights, originating in the use of any product data, diagrams, charts or circuit application examples contained in the materials.
·All information contained in these materials, including product data, diagrams and charts, represent information on products at the time of publication of these materials, and are subject to change by Isahaya Electronics Corporation without notice due to product improvements or other reasons. It is therefore recommended that customers contact Isahaya Electronics Corporation or authorized Isahaya Semiconductor product distributor for the latest product information before purchasing a product listed herein.
·The prior written approval of Isahaya Electronics Corporation is necessary to reprint or reproduce in whole or in part these materials.
·If these products or technologies are subject to the Japanese export control restrictions, they must be exported under a license from the Japanese government and cannot be imported into a country other than the approved destination. Any diversion or reexport contrary to the export control laws and regulations of Japan and/or the country of destination is prohibited.
·Please contact Isahaya Electronics Corporation or an authorized Isahaya Semiconductor product distributor for further details on these materials or the products contained therein.
