

Low-frequency Transistor

(-80V , -0.5A)

2SB1198K

●Features

- 1) Low $V_{CE(sat)}$.
 $V_{CE(sat)} = -0.2\text{V}$ (Typ.)
($I_c / I_B = -0.5\text{A} / -50\text{mA}$)
- 2) High breakdown voltage.
 $BV_{CEO} = -80\text{V}$
- 3) Complements the 2SD1782K.

●Structure

Epitaxial planar type
PNP silicon transistor

●External dimensions (Unit:s mm)

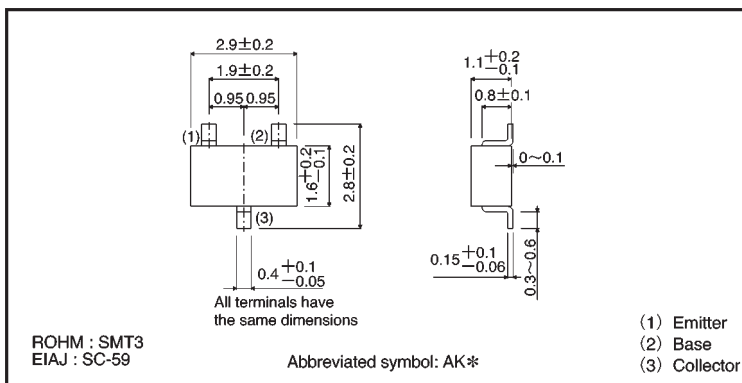

●Absolute maximum ratings ($T_a = 25^\circ\text{C}$)

* Denotes h_{FE}

Parameter	Symbol	Limits	Unit
Collector-base voltage	V_{CBO}	-80	V
Collector-emitter voltage	V_{CEO}	-80	V
Emitter-base voltage	V_{EBO}	-5	V
Collector current	I_c	-0.5	A
Collector power dissipation	P_C	0.2	W
Junction temperature	T_j	150	$^\circ\text{C}$
Storage temperature	T_{stg}	$-55 \sim +150$	$^\circ\text{C}$

●Electrical characteristics ($T_a = 25^\circ\text{C}$)

Parameter	Symbol	Min.	Typ.	Max.	Unit	Conditions
Collector-base breakdown voltage	BV_{CBO}	-80	—	—	V	$I_C = -50 \mu\text{A}$
Collector-emitter breakdown voltage	BV_{CEO}	-80	—	—	V	$I_C = -2\text{mA}$
Emitter-base breakdown voltage	BV_{EBO}	-5	—	—	V	$I_E = -50 \mu\text{A}$
Collector cutoff current	I_{CBO}	—	—	-0.5	μA	$V_{CB} = -50\text{V}$
Emitter cutoff current	I_{EBO}	—	—	-0.5	μA	$V_{EB} = -4\text{V}$
Collector-emitter saturation voltage	$V_{CE(sat)}$	—	-0.2	-0.5	V	$I_C / I_B = -0.5\text{A} / -50\text{mA}$
DC current transfer ratio	h_{FE}	120	—	390	—	$V_{CE} = -3\text{V}$, $I_C = -0.1\text{A}$
Transition frequency	f_T	—	180	—	MHz	$V_{CE} = -10\text{V}$, $I_E = 50\text{mA}$, $f = 100\text{MHz}$
Output capacitance	C_{ob}	—	11	—	pF	$V_{CB} = -10\text{V}$, $I_E = 0\text{A}$, $f = 1\text{MHz}$

● Packaging specifications and h_{FE}

Type	h_{FE}	Package	Taping
		Code	T146
		Basic ordering unit (pieces)	3000
2SB1198K	QR		○

h_{FE} values are classified as follows :

Item	Q	R
h_{FE}	120~270	180~390

● Electrical characteristic curves

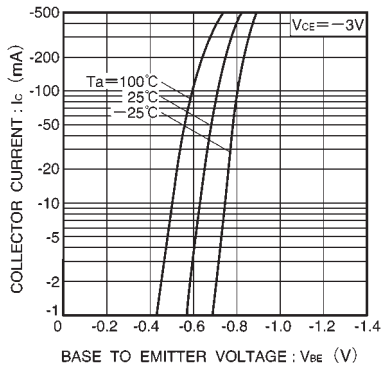

Fig.1 Grounded emitter propagation characteristics

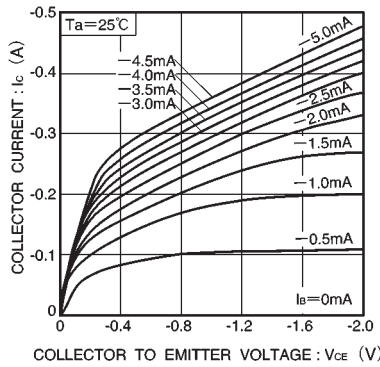

Fig.2 Grounded emitter output characteristics

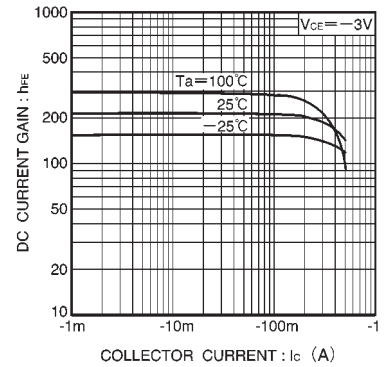

Fig.3 DC current gain vs. collector current

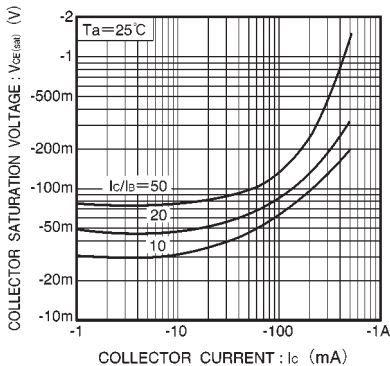

Fig.4 Collector-emitter saturation voltage vs. collector current (I)

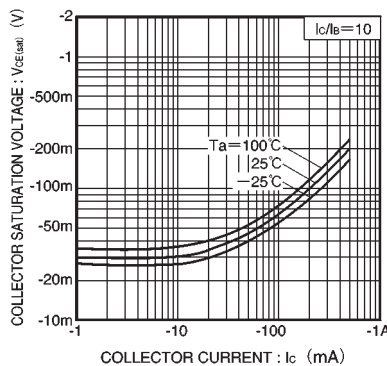

Fig.5 Collector-emitter saturation voltage vs. collector current (II)

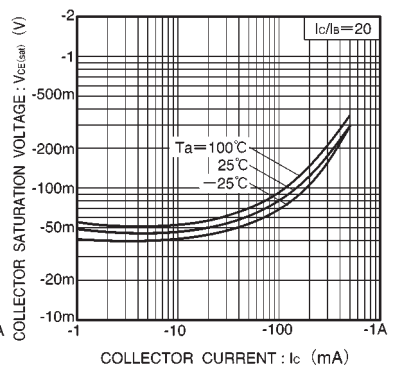

Fig.6 Collector-emitter saturation voltage vs. collector current (III)

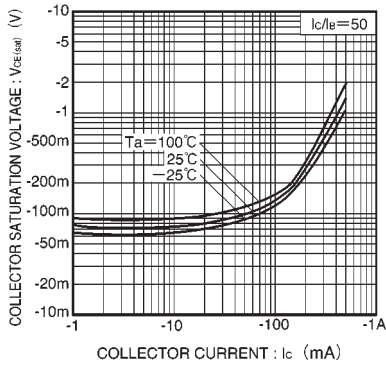

Fig.7 Collector-emitter saturation voltage vs. collector current (I_V)

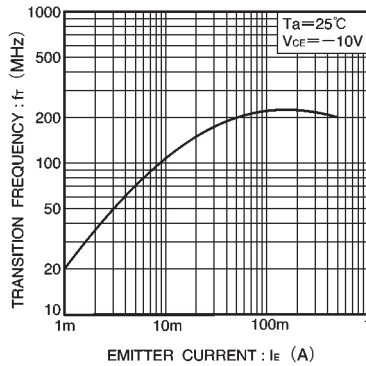

Fig.8 Gain bandwidth product vs. emitter current

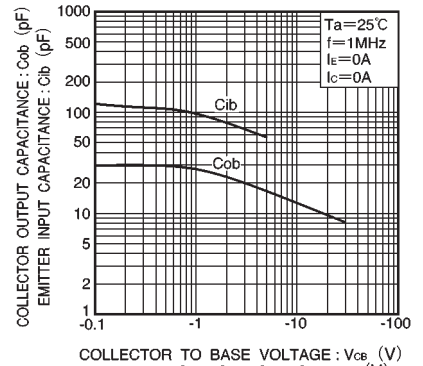

Fig.9 Collector output capacitance vs. collector-base voltage
Emitter input capacitance vs. emitter-base voltage