

DESCRIPTION The 2SA992 is best for use as the middle range amplifier in Hi-Fi stereo control amplifiers, power amplifiers, and etc.

- FEATURES**
- High Voltage. $V_{CEO} : -120\text{ V}$
 - Low Output Capacitance. $C_{ob} : 2.0\text{ pF TYP. } (V_{CB} = -30\text{ V})$
 - High h_{FE} . $h_{FE} : 500\text{ TYP. } (V_{CE} = -6.0\text{ V, } I_C = -1.0\text{ mA})$
 - Super Low Noise. $NV : 25\text{ mV TYP. } (See\ test\ circuit.)$
 - Complementary to 2SC1845.

ABSOLUTE MAXIMUM RATINGS

- Maximum Temperatures
- Storage Temperature $-55\text{ to }+125\text{ }^\circ\text{C}$
 - Junction Temperature $+125\text{ }^\circ\text{C Maximum}$
- Maximum Power Dissipation ($T_a = 25\text{ }^\circ\text{C}$)
- Total Power Dissipation 500 mW
- Maximum Voltages and Currents ($T_a = 25\text{ }^\circ\text{C}$)
- V_{CBO} Collector to Base Voltage -120 V
 - V_{CEO} Collector to Emitter Voltage -120 V
 - V_{EBO} Emitter to Base Voltage -5.0 V
 - I_C Collector Current -50 mA
 - I_B Base Current -10 mA

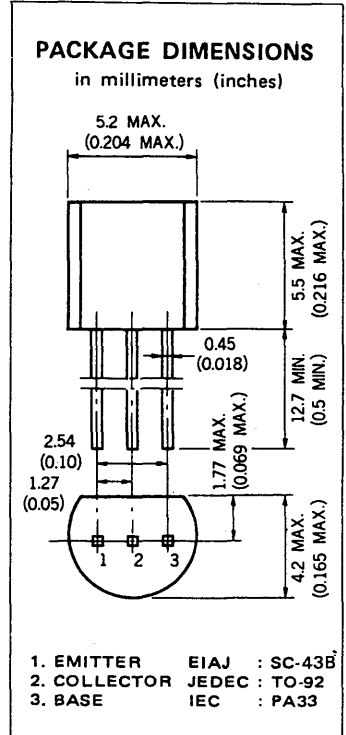

ELECTRICAL CHARACTERISTICS ($T_a = 25\text{ }^\circ\text{C}$)

SYMBOL	CHARACTERISTIC	MIN.	TYP.	MAX.	UNIT	TEST CONDITIONS
h_{FE1}	DC Current Gain	150	500		—	$V_{CE} = -6.0\text{ V, } I_C = -0.1\text{ mA}$
h_{FE2}	DC Current Gain	200	500	800	—	$V_{CE} = -6.0\text{ V, } I_C = -1.0\text{ mA}$
f_T	Gain Bandwidth Product	50	100		MHz	$V_{CE} = -6.0\text{ V, } I_E = 1.0\text{ mA}$
C_{ob}	Output Capacitance		2.0	3.0	pF	$V_{CB} = -30\text{ V, } I_E = 0, f = 1.0\text{ MHz}$
NV	Noise Voltage		25	40	mV	$V_{CE} = -5.0\text{ V, } I_C = -1.0\text{ mA, } R_G = 100\text{ k}\Omega$ $G_v = 80\text{ dB, } f = 10\text{ Hz to }1.0\text{ kHz}$
I_{CBO}	Collector Cutoff Current			-50	nA	$V_{CB} = -120\text{ V, } I_E = 0$
I_{EBO}	Emitter Cutoff Current			-50	nA	$V_{EB} = -5.0\text{ V, } I_C = 0$
V_{BE}	Base to Emitter Voltage	-0.55	-0.61	-0.65	V	$V_{CE} = -6.0\text{ V, } I_C = -1.0\text{ mA}$
$V_{CE(sat)}$	Collector Saturation Voltage		-0.09	-0.30	V	$I_C = -10\text{ mA, } I_B = -1.0\text{ mA}$

Classification of h_{FE2}

Rank	P	F	E
Range	200 - 400	300 - 600	400 - 800

h_{FE} Test Conditions : $V_{CE} = -6.0\text{ V, } I_C = -1.0\text{ mA}$

TYPICAL CHARACTERISTICS ($T_a = 25^\circ\text{C}$ unless otherwise noted)

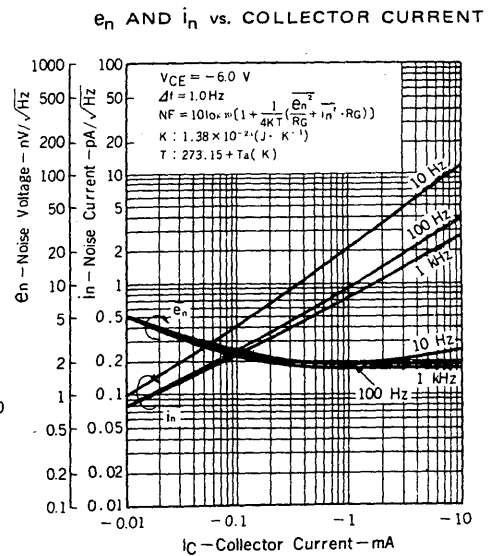
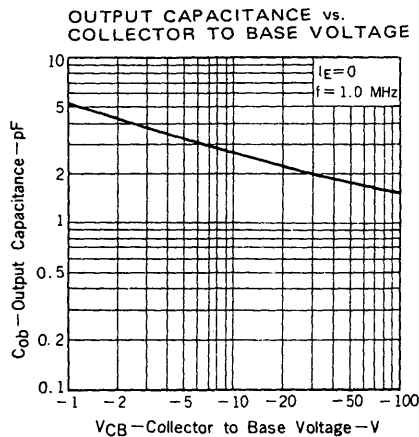
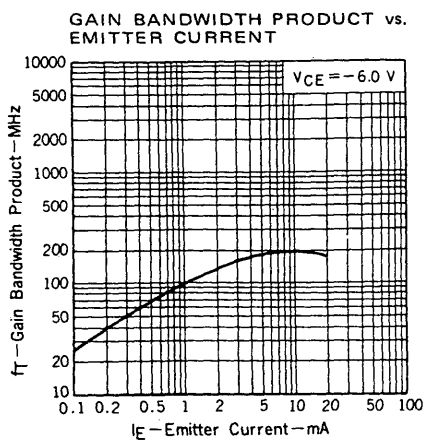
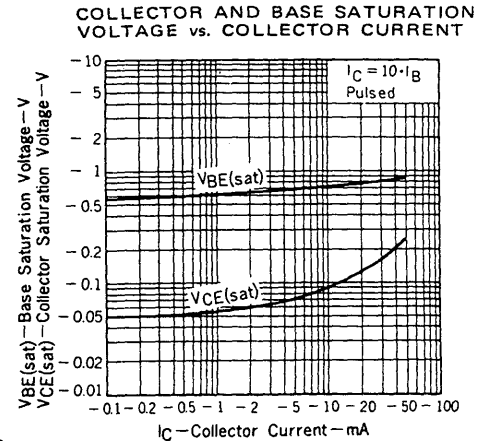
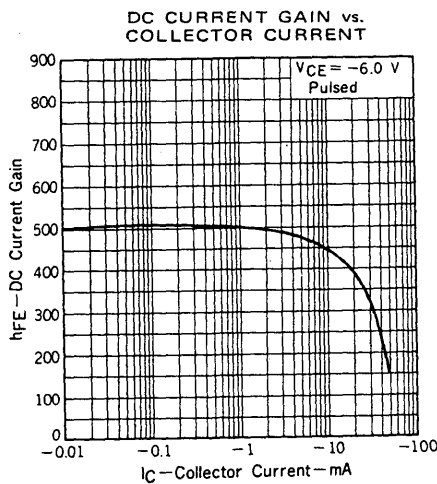
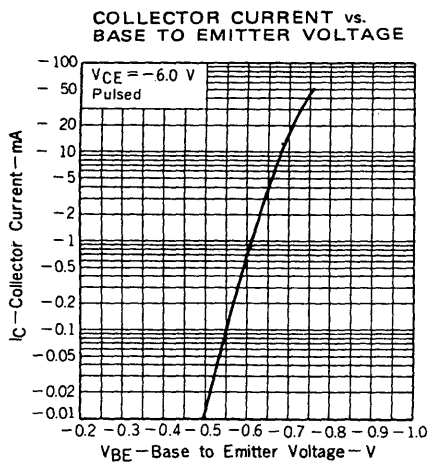
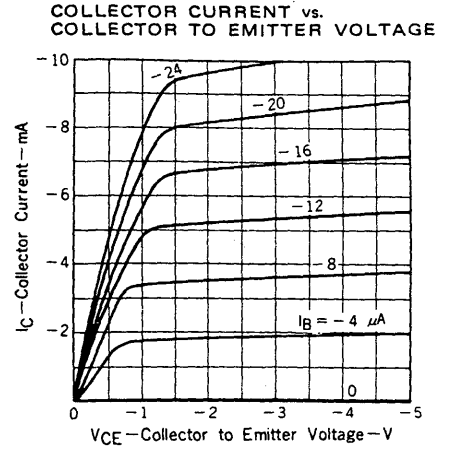
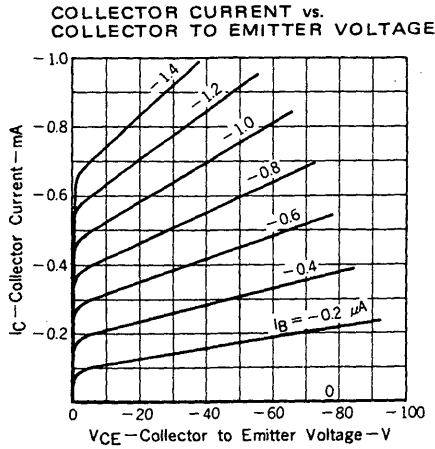
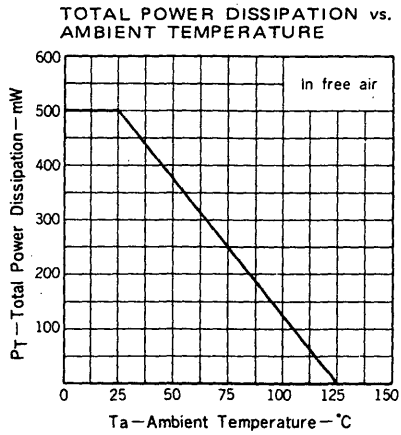

NOISE FIGURE MAP.

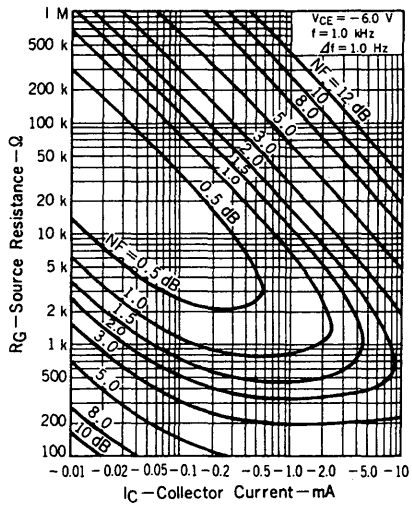

NOISE VOLTAGE TEST CIRCUIT

