

**PNP EPITAXIAL SILICON TRANSISTOR  
MICROWAVE AMPLIFIER**

**FEATURES**

- High  $f_T$   
 $f_T = 5.5$  GHz TYP.
- $|S_{21e}|^2 = 10.0$  dB TYP. @  $f = 1.0$  GHz,  $V_{CE} = -10$  V,  $I_C = -15$  mA
- High speed switching characteristics
- Equivalent NPN transistor is the 2SC2351.
- Alternative of the 2SA1424.

**ABSOLUTE MAXIMUM RATINGS ( $T_A = 25$  °C)**

Parameter	Symbol	Rating	Unit
Collector to Base Voltage	$V_{CB0}$	-20	V
Collector to Emitter Voltage	$V_{CE0}$	-12	V
Emitter to Base Voltage	$V_{EB0}$	-3.0	V
Collector Current	$I_C$	-50	mA
Total Power Dissipation	$P_T$	200	mW
Junction Temperature	$T_j$	150	°C
Storage Temperature	$T_{stg}$	-65 to +150	°C

**PACKAGE DIMENSIONS**

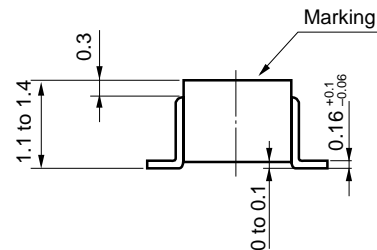
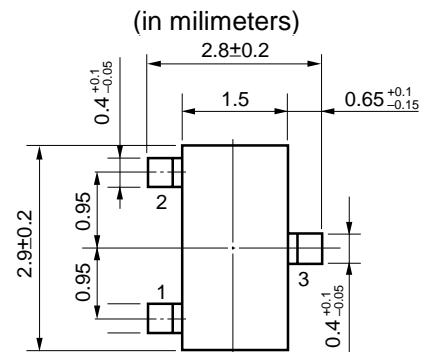

**PIN CONNECTIONS**

- 1: Emitter  
2: Base  
3: Collector    Marking: T93

**ELECTRICAL CHARACTERISTICS ( $T_A = 25$  °C)**

Parameter	Symbol	Test Conditions	MIN.	TYP.	MAX.	Unit
Collector Cutoff Current	$I_{CB0}$	$V_{CB} = -10$ V			-0.1	$\mu$ A
Emitter Cutoff Current	$I_{EB0}$	$V_{EB} = -2$ V			-0.1	$\mu$ A
DC Current Gain	$h_{FE}$	$V_{CE} = -10$ V, $I_C = -15$ mA	20	40	100	
Gain Bandwidth Product	$f_T$	$V_{CE} = -10$ V, $I_C = -15$ mA	4.0	5.5		GHz
Collector Capacitance	$C_{re}^*$	$V_{CB} = -10$ V, $I_E = 0$ , $f = 1$ MHz		0.5	1	pF
Insertion Power Gain	$ S_{21e} ^2$	$V_{CE} = -10$ V, $I_C = -15$ mA, $f = 1.0$ GHz	8.0	10.0		dB
Noise Figure	NF	$V_{CE} = -10$ V, $I_C = -3.0$ mA, $f = 1$ GHz		2.0	3	dB

\* Measured by a 3-terminal bridge. Emitter and Case should be connected to the guard terminal.

**$h_{FE}$  Classification**

Rank	FB
Marking	T93
$h_{FE}$	20 to 100

**SWITCHING CHARACTERISTICS**

Parameter	Symbol	$V_{in} = 1\text{ V}$	Unit
		TYP	
Turn-on Delay Time	$t_{on} \text{ (delay)}$	1.10	ns
Rise Time	$t_r$	0.77	ns
Turn off Delay Time	$t_{off} \text{ (delay)}$	0.40	ns
Fall Time	$t_f$	0.79	ns

**SWITCHING TIME MEASUREMENT CIRCUIT**

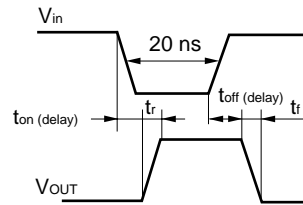
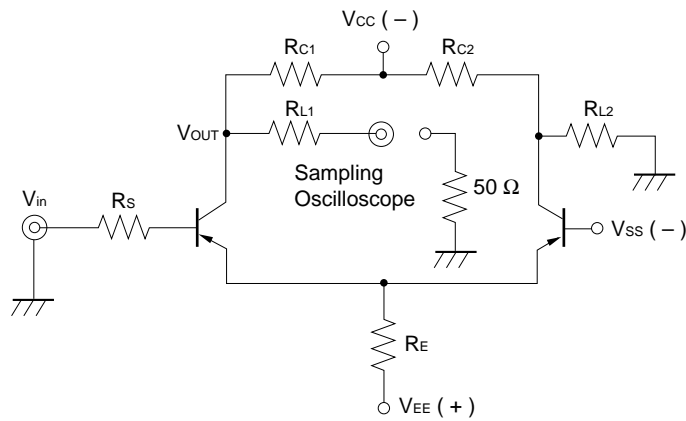

$V_{in} = 1\text{ V}, V_{BB} = -0.5\text{ V}, R_{C1} = R_{C2}$						
$R_s$	$R_C$	$R_{L1}$	$R_{L2}$	$R_E$	$V_{EE}$	$V_{CC}$
( $\Omega$ )	( $\Omega$ )	( $\Omega$ )	( $\Omega$ )	( $\Omega$ )	(V)	(V)
160	1 k	200	250	2.7 k	27	26.3

TYPICAL CHARACTERISTICS

TOTAL POWER DISSIPATION vs. AMBIENT TEMPERATURE

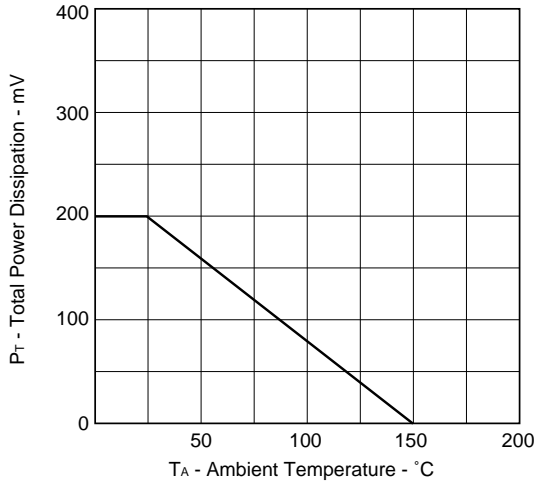

NOISE FIGURE vs. COLLECTOR CURRENT

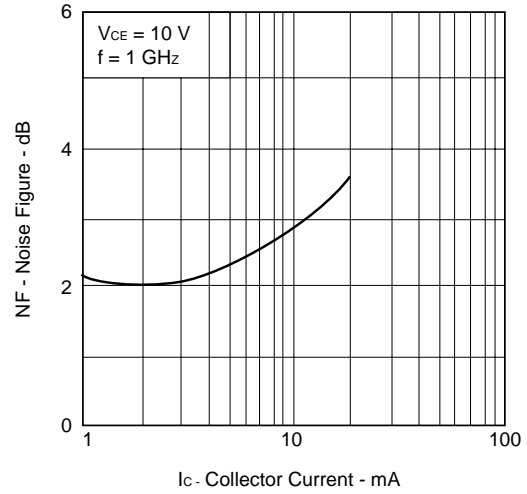

BASE TO EMITTER VOLTAGE vs. COLLECTOR CURRENT

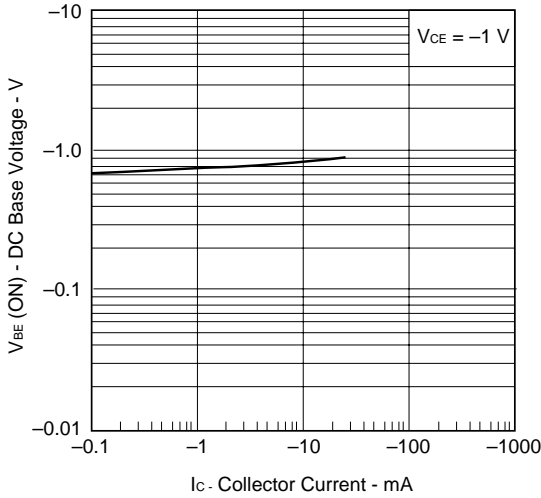

COLLECTOR SATURATION AND BASE TO EMITTER VOLTAGE vs. COLLECTOR CURRENT

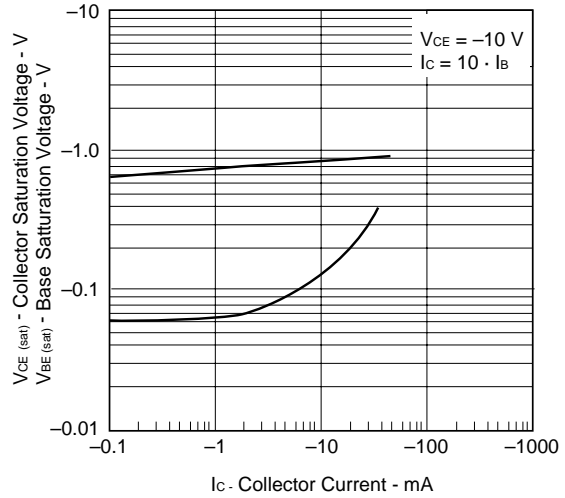

INSERTION GAIN vs. COLLECTOR CURRENT

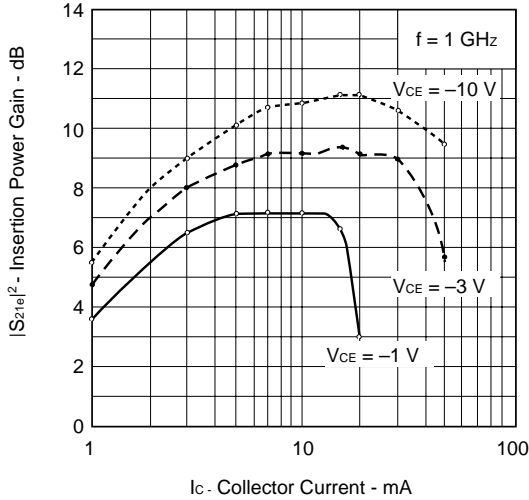

GAIN BANDWIDTH PRODUCT vs. COLLECTOR CURRENT

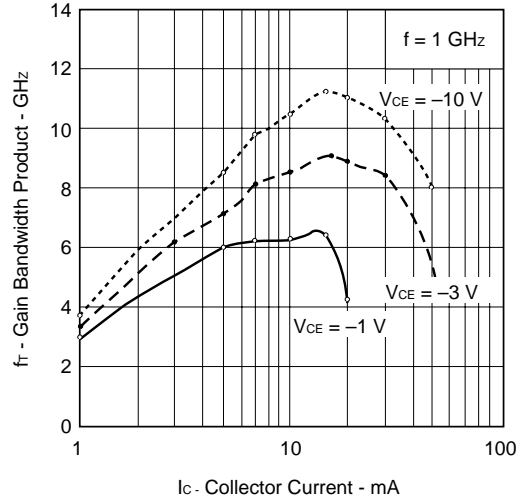

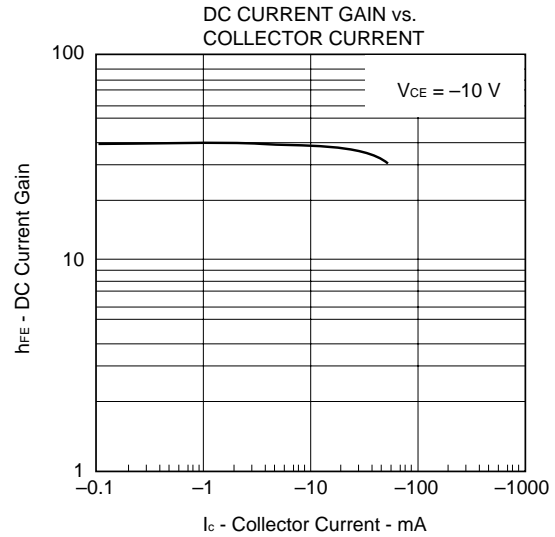
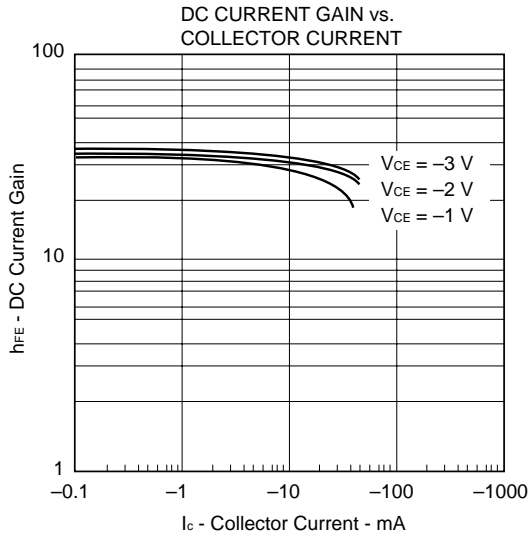
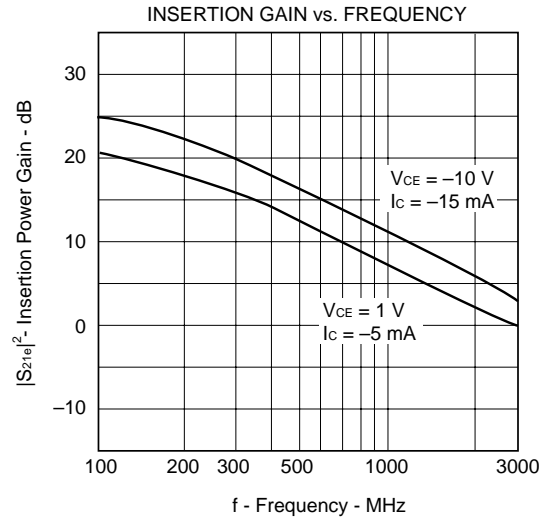
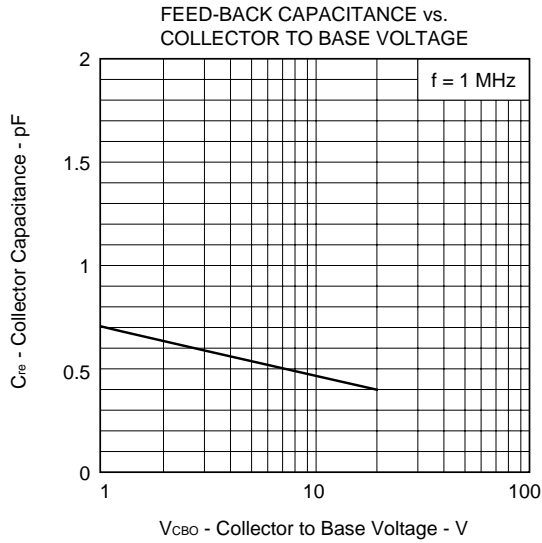

S-PARAMETER

S11

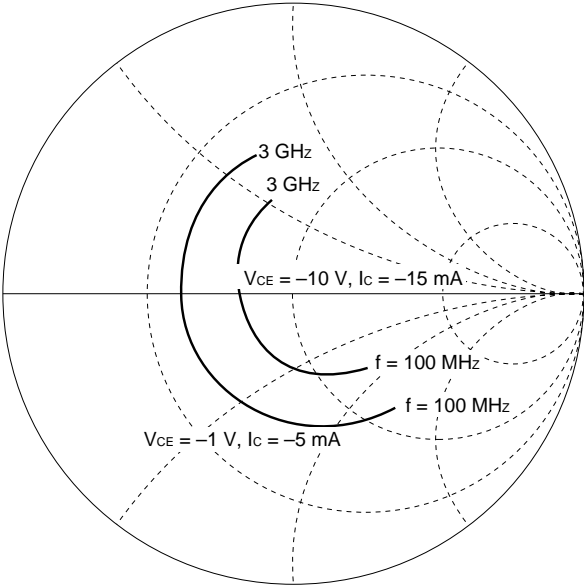

S22

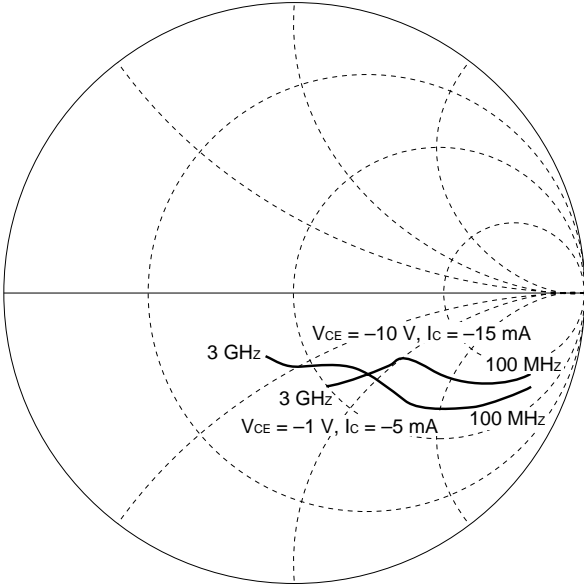

**S-PARAMETER**

( $V_{CE} = 1\text{ V}$ ,  $I_C = 5\text{ mA}$ ,  $Z_o = 50\ \Omega$ )

f MHz	S <sub>11</sub>		S <sub>21</sub>		S <sub>12</sub>		S <sub>22</sub>	
	MAG	ANG	MAG	ANG	MAG	ANG	MAG	ANG
100	0.527	-47.1	10.5	149.	0.0359	70.6	0.881	-21.1
200	0.468	-83.4	8.37	128.	0.0584	58.7	0.716	-34.2
300	0.427	-109	6.63	114.	0.0729	53.6	0.586	-40.9
400	0.407	-128	5.36	104.	0.0835	52.1	0.503	-44.3
500	0.393	-143	4.46	96.6	0.0930	52.1	0.443	-45.8
600	0.388	-154	3.82	90.2	0.100	53.1	0.401	-46.7
700	0.386	-164	3.34	84.9	0.109	53.3	0.373	-47.7
800	0.388	-172	2.96	80.1	0.118	54.4	0.351	-49.1
900	0.392	-179	2.67	75.8	0.128	55.6	0.332	-50.1
1000	0.394	174	2.43	71.6	0.137	56.4	0.319	-51.4
1100	0.399	169	2.24	68.1	0.147	56.9	0.306	-53.2
1200	0.405	163	2.07	64.6	0.158	57.2	0.298	-54.5
1300	0.410	159	1.93	61.3	0.168	57.6	0.289	-57.0
1400	0.416	154	1.81	58.0	0.179	57.7	0.280	-59.3
1500	0.422	150	1.71	54.9	0.190	57.7	0.274	-61.2
1600	0.431	147	1.62	52.0	0.201	57.7	0.267	-64.4
1700	0.438	143	1.54	49.3	0.213	57.5	0.262	-66.7
1800	0.445	140	1.47	46.6	0.224	57.2	0.259	-70.3
1900	0.451	136	1.41	44.1	0.236	56.8	0.252	-73.6
2000	0.460	133	1.35	41.5	0.248	56.3	0.247	-76.3
2100	0.465	130	1.30	39.2	0.261	55.7	0.243	-80.2
2200	0.473	127	1.26	36.9	0.273	55.1	0.239	-84.4
2300	0.481	125	1.21	34.8	0.286	54.3	0.234	-87.2
2400	0.487	122	1.17	32.5	0.299	53.3	0.235	-91.9
2500	0.493	119	1.14	30.6	0.312	52.6	0.230	-95.9

**S-PARAMETER**

( $V_{CE} = 3\text{ V}$ ,  $I_C = 5\text{ mA}$ ,  $Z_o = 50\ \Omega$ )

f MHz	S <sub>11</sub>		S <sub>21</sub>		S <sub>12</sub>		S <sub>22</sub>	
	MAG	ANG	MAG	ANG	MAG	ANG	MAG	ANG
100	0.558	- 37.1	11.0	153.	0.0288	74.3	915	- 16.3
200	0.485	- 67.9	9.13	133.	0.0467	83.0	784	- 27.0
300	0.423	- 92.5	7.48	119.	0.0611	58.1	670	- 33.0
400	0.381	- 111	6.21	109.	0.0703	56.5	590	- 36.0
500	0.353	- 127	5.18	101.	0.0801	56.1	531	- 37.4
600	0.339	- 140	4.47	95.1	0.0880	56.7	490	- 38.1
700	0.329	- 151	3.92	89.9	0.0938	57.5	461	- 33.8
800	0.325	- 160	3.48	84.9	0.104	57.9	438	- 39.8
900	0.325	- 169	3.14	80.7	0.113	58.7	419	- 40.4
1000	0.326	- 176	2.87	76.9	0.122	59.5	408	- 41.6
1100	0.330	177	2.64	73.0	0.131	60.5	393	- 42.8
1200	0.335	170	2.44	69.6	0.140	61.2	386	- 44.0
1300	0.339	165	2.28	66.5	0.150	61.3	377	- 45.9
1400	0.345	160	2.13	63.3	0.160	61.9	366	- 47.5
1500	0.351	155	2.01	60.2	0.170	61.9	362	- 49.0
1600	0.360	151	1.90	57.4	0.181	61.8	354	- 51.0
1700	0.366	147	1.81	54.6	0.191	61.8	349	- 53.0
1800	0.374	143	1.72	52.0	0.202	61.7	344	- 55.5
1900	0.382	140	1.65	49.5	0.213	61.3	337	- 58.1
2000	0.390	137	1.58	47.0	0.223	61.0	334	- 60.4
2100	0.396	133	1.52	44.6	0.233	60.4	328	- 63.0
2200	0.404	130	1.46	42.4	0.243	60.2	321	- 65.9
2300	0.413	127	1.41	40.2	0.251	59.4	318	- 68.3
2400	0.418	125	1.36	38.0	0.273	58.9	314	- 72.1
2500	0.427	122	1.32	35.9	0.255	58.2	303	- 74.8

**S-PARAMETER**

( $V_{CE} = 10\text{ V}$ ,  $I_C = 5\text{ mA}$ ,  $Z_o = 50\ \Omega$ )

f MHz	S <sub>11</sub>		S <sub>21</sub>		S <sub>12</sub>		S <sub>22</sub>	
	MAG	ANG	MAG	ANG	MAG	ANG	MAG	ANG
100	0.529	-28.8	11.3	156.	0.0234	75.4	0.939	-12.8
200	0.548	-53.5	9.70	138.	0.0412	67.4	0.836	-21.7
300	0.463	-73.9	8.20	124.	0.0530	62.1	0.739	-27.2
400	0.400	-91.4	6.94	114.	0.0620	59.7	0.666	-29.9
500	0.349	-106	5.86	106.	0.0712	58.9	0.608	-31.4
600	0.316	-119	5.09	100.	0.0793	59.8	0.567	-31.9
700	0.292	-131	4.49	94.6	0.0860	59.6	0.539	-32.7
800	0.277	-141	4.00	89.7	0.0938	60.4	0.516	-33.5
900	0.267	-152	3.63	85.4	0.101	61.3	0.498	-34.2
1000	0.261	-160	3.31	81.5	0.109	61.9	0.485	-35.1
1100	0.259	-169	3.04	77.9	0.117	62.8	0.472	-35.9
1200	0.260	-177	2.82	74.5	0.125	63.2	0.463	-36.9
1300	0.263	176	2.63	71.3	0.133	63.9	0.455	-38.4
1400	0.267	169	2.46	68.2	0.143	64.4	0.448	-39.5
1500	0.272	164	2.32	65.3	0.152	64.5	0.440	-40.8
1600	0.280	159	2.20	62.5	0.161	64.6	0.434	-42.5
1700	0.286	154	2.09	59.8	0.171	64.9	0.428	-44.1
1800	0.293	149	1.99	57.3	0.191	64.8	0.423	-46.0
1900	0.300	145	1.90	54.8	0.192	64.4	0.417	-47.8
2000	0.308	141	1.82	52.3	0.201	64.5	0.413	-49.7
2100	0.315	138	1.75	49.9	0.212	63.9	0.408	-51.9
2200	0.325	134	1.68	47.6	0.223	63.8	0.402	-54.3
2300	0.333	131	1.63	45.5	0.235	63.2	0.397	-56.1
2400	0.341	128	1.57	43.3	0.246	62.7	0.395	-58.7
2500	0.348	125	1.52	41.2	0.258	62.1	0.388	-61.0



**S-PARAMETER**

( $V_{CE} = 10\text{ V}$ ,  $I_C = 15\text{ mA}$ ,  $Z_o = 50\ \Omega$ )

f MHz	S <sub>11</sub>		S <sub>21</sub>		S <sub>12</sub>		S <sub>22</sub>	
	MAG	ANG	MAG	ANG	MAG	ANG	MAG	ANG
100	0.354	- 46.6	17.87	147.	0.0190	74.6	866	- 18.3
200	0.290	- 81.8	13.45	125.	0.0317	70.0	708	- 26.9
300	0.247	- 107	10.35	113.	0.0420	68.4	601	- 29.8
400	0.226	- 126	8.294	104.	0.0518	68.3	539	- 30.5
500	0.215	- 141	6.799	97.8	0.0626	69.8	497	- 30.2
600	0.210	- 154	5.805	92.4	0.0720	70.8	470	- 30.1
700	0.208	- 164	5.050	88.1	0.0820	71.0	450	- 30.2
800	0.211	- 172	4.475	84.1	0.0919	70.9	435	- 30.6
900	0.215	179	4.008	80.5	0.102	70.9	423	- 31.1
1000	0.218	172	3.647	77.2	0.112	70.7	415	- 32.2
1100	0.225	166	3.345	74.2	0.121	70.9	405	- 32.9
1200	0.232	160	3.086	71.1	0.133	70.3	400	- 34.2
1300	0.237	156	2.871	68.4	0.143	70.2	394	- 35.7
1400	0.244	151	2.685	65.7	0.153	69.7	386	- 36.8
1500	0.251	147	2.532	63.2	0.165	69.2	381	- 38.4
1600	0.261	143	2.392	60.5	0.174	68.7	376	- 39.9
1700	0.268	140	2.265	58.2	0.185	68.0	373	- 41.6
1800	0.276	137	2.155	55.7	0.196	67.3	366	- 43.7
1900	0.284	134	2.059	53.5	0.207	66.5	360	- 45.7
2000	0.292	131	1.974	51.1	0.219	65.8	356	- 47.5
2100	0.299	128	1.897	49.0	0.230	65.1	350	- 49.7
2200	0.308	125	1.826	46.9	0.242	64.2	345	- 51.8
2300	0.317	123	1.763	44.7	0.252	63.3	341	- 53.8
2400	0.324	121	1.697	42.7	0.264	62.4	337	- 56.7
2500	0.332	119	1.646	40.7	0.276	61.5	331	- 58.8

No part of this document may be copied or reproduced in any form or by any means without the prior written consent of NEC Corporation. NEC Corporation assumes no responsibility for any errors which may appear in this document.

NEC Corporation does not assume any liability for infringement of patents, copyrights or other intellectual property rights of third parties by or arising from use of a device described herein or any other liability arising from use of such device. No license, either express, implied or otherwise, is granted under any patents, copyrights or other intellectual property rights of NEC Corporation or others.

While NEC Corporation has been making continuous effort to enhance the reliability of its semiconductor devices, the possibility of defects cannot be eliminated entirely. To minimize risks of damage or injury to persons or property arising from a defect in an NEC semiconductor device, customer must incorporate sufficient safety measures in its design, such as redundancy, fire-containment, and anti-failure features.

NEC devices are classified into the following three quality grades:

“Standard”, “Special”, and “Specific”. The Specific quality grade applies only to devices developed based on a customer designated "quality assurance program" for a specific application. The recommended applications of a device depend on its quality grade, as indicated below. Customers must check the quality grade of each device before using it in a particular application.

Standard : Computers, office equipment, communications equipment, test and measurement equipment, audio and visual equipment, home electronic appliances, machine tools, personal electronic equipment and industrial robots

Special: Transportation equipment (automobiles, trains, ships, etc.), traffic control systems, anti-disaster systems, anti-crime systems, safety equipment and medical equipment (not specifically designed for life support)

Specific: Aircrafts, aerospace equipment, submersible repeaters, nuclear reactor control systems, life support systems or medical equipment for life support, etc.

The quality grade of NEC devices in “Standard” unless otherwise specified in NEC's Data Sheets or Data Books.

If customers intend to use NEC devices for applications other than those specified for Standard quality grade, they should contact NEC Sales Representative in advance.

Anti-radioactive design is not implemented in this product.