

### PNP EPITAXIAL SILICON TRANSISTOR MICROWAVE AMPLIFIER

#### FEATURES

- High  $f_T$   
 $f_T = 8.5$  GHz TYP.
- High gain  
 $|S_{21e}|^2 = 12.0$  dB TYP. @  $f = 1.0$  GHz,  $V_{CE} = -8$  V,  $I_C = -20$  mA
- High-speed switching characteristics
- Equivalent NPN transistor is the 2SC3583.

#### ABSOLUTE MAXIMUM RATINGS ( $T_A = 25$ °C)

Parameter	Symbol	Rating	Unit
Collector to Base Voltage	$V_{CB0}$	-20	V
Collector to Emitter Voltage	$V_{CE0}$	-12	V
Emitter to Base Voltage	$V_{EB0}$	-3.0	V
Collector Current	$I_C$	-50	mA
Total Power Dissipation	$P_T$	200	mW
Junction Temperature	$T_j$	150	°C
Storage Temperature	$T_{stg}$	-65 to +150	°C

#### PACKAGE DIMENSION (in millimeters)

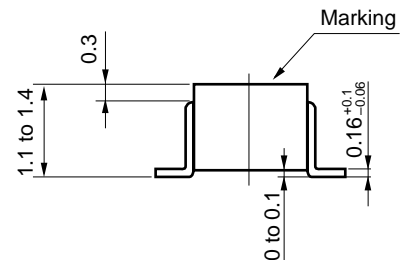
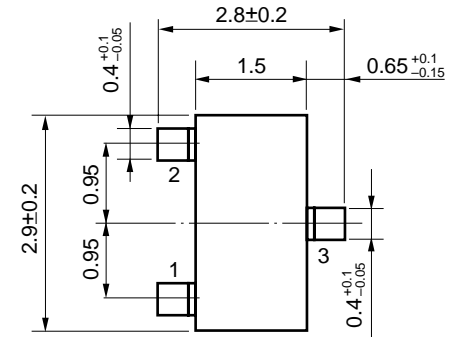

#### PIN CONNECTIONS

- 1: Emitter  
2: Base  
3: Collector    Marking: T92

#### ELECTRICAL CHARACTERISTICS ( $T_A = 25$ °C)

Parameter	Symbol	Test Conditions	MIN.	TYP.	MAX.	Unit
Collector Cutoff Current	$I_{CB0}$	$V_{CB} = -10$ V			-0.1	$\mu$ A
Emitter Cutoff Current	$I_{EB0}$	$V_{EB} = -1$ V			-0.1	$\mu$ A
DC Current Gain	$h_{FE}$	$V_{CE} = -8$ V, $I_C = -20$ mA	20		100	
Gain Bandwidth Product	$f_T$	$V_{CE} = -8$ V, $I_C = -20$ mA, $f = 1$ GHz	6.0	8.5		GHz
Collector Capacitance	$C_{re}^*$	$V_{CB} = -10$ V, $I_E = 0$ , $f = 1$ MHz		0.5	1	pF
Insertion Power Gain	$ S_{21e} ^2$	$V_{CE} = -8$ V, $I_C = -20$ mA, $f = 1.0$ GHz	8.0	12.0		dB
Noise Figure	NF	$V_{CE} = -8$ V, $I_C = -3$ mA, $f = 1$ GHz		1.5	3	dB

\* Measured by a 3-terminal bridge. Emitter and Case should be connected to the guard terminal.

#### $h_{FE}$ Classification

Rank	FB
Marking	T92
$h_{FE}$	20 to 100

**SWITCHING CHARACTERISTICS**

Parameter	Symbol	$V_{in} = 1\text{ V}$	Unit
		TYP.	
Turn-on Delay Time	$t_{on} \text{ (delay)}$	1.08	ns
Rise Time	$t_r$	0.66	ns
Turn off Delay Time	$t_{off} \text{ (delay)}$	0.32	ns
Fall Time	$t_f$	0.78	ns

**SWITCHING TIME MEASUREMENT CIRCUIT**

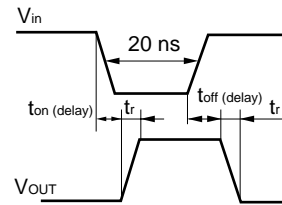
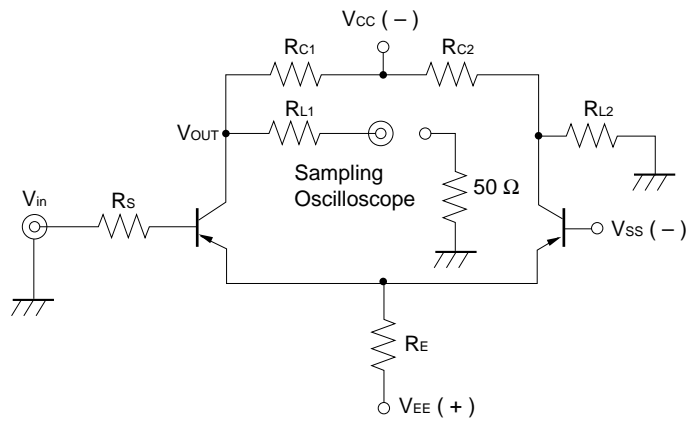

$V_{in} = 1\text{ V}, V_{BB} = -0.5\text{ V}, R_{C1} = R_{C2}$						
$R_s$	$R_C$	$R_{L1}$	$R_{L2}$	$R_E$	$V_{EE}$	$V_{CC}$
( $\Omega$ )	( $\Omega$ )	( $\Omega$ )	( $\Omega$ )	( $\Omega$ )	(V)	(V)
160	1 k	200	250	2.7 k	27	26.3

TYPICAL CHARACTERISTICS

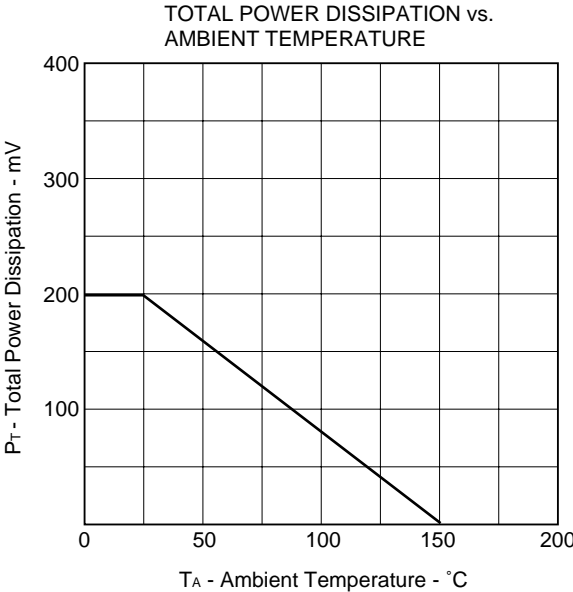

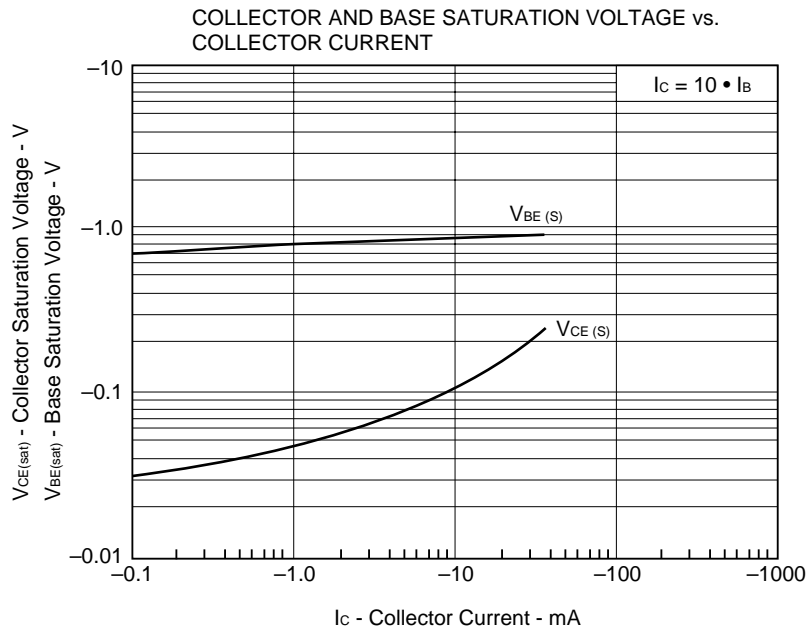
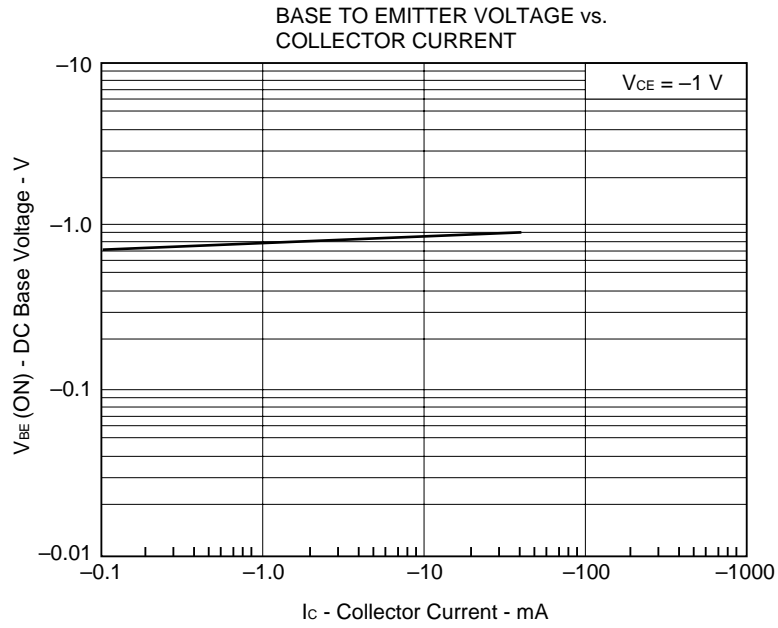

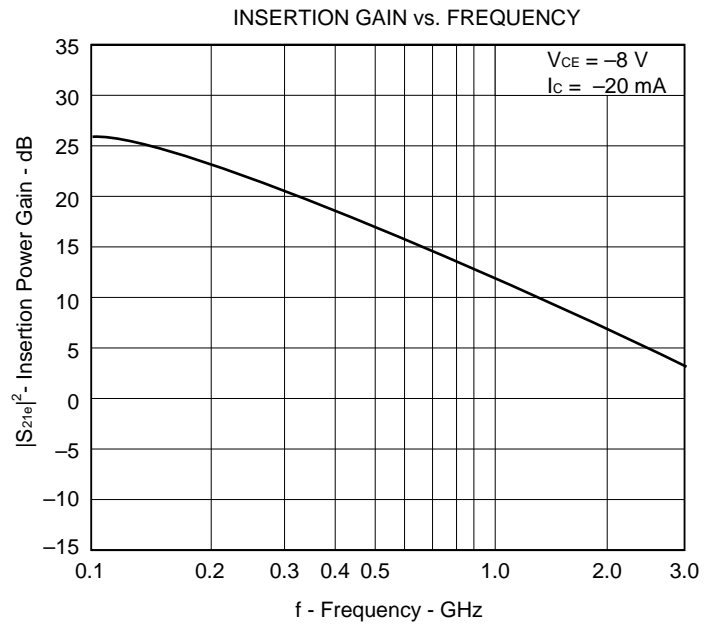
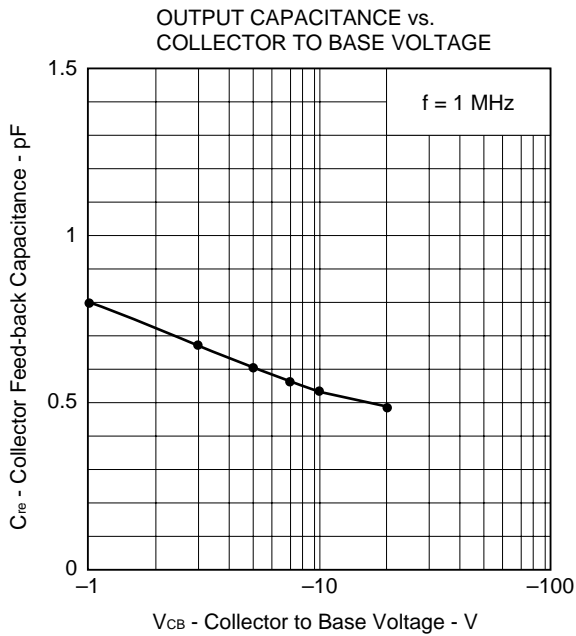
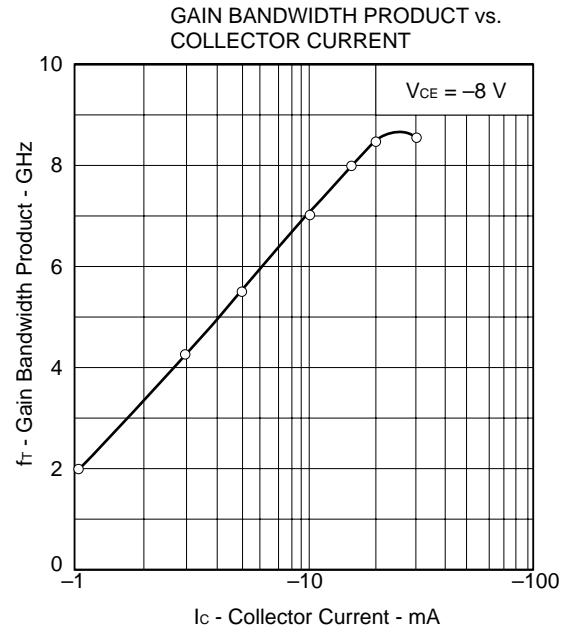
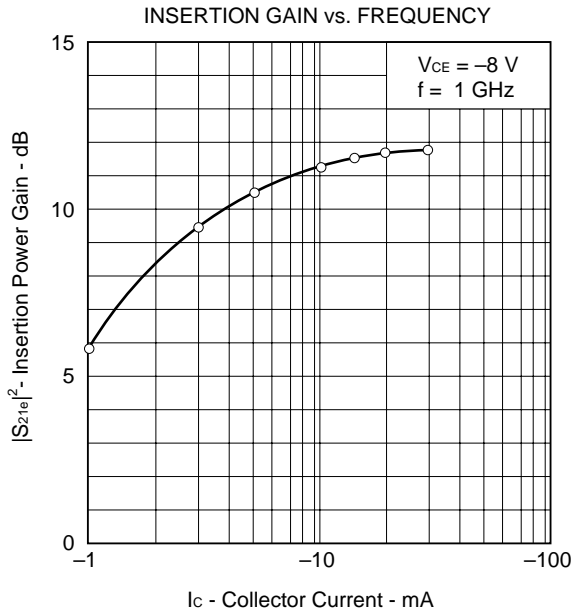

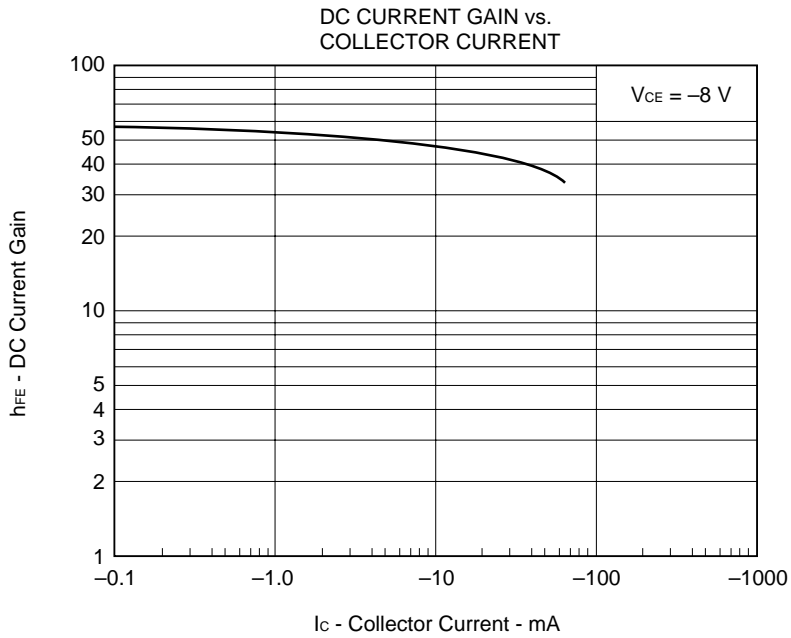
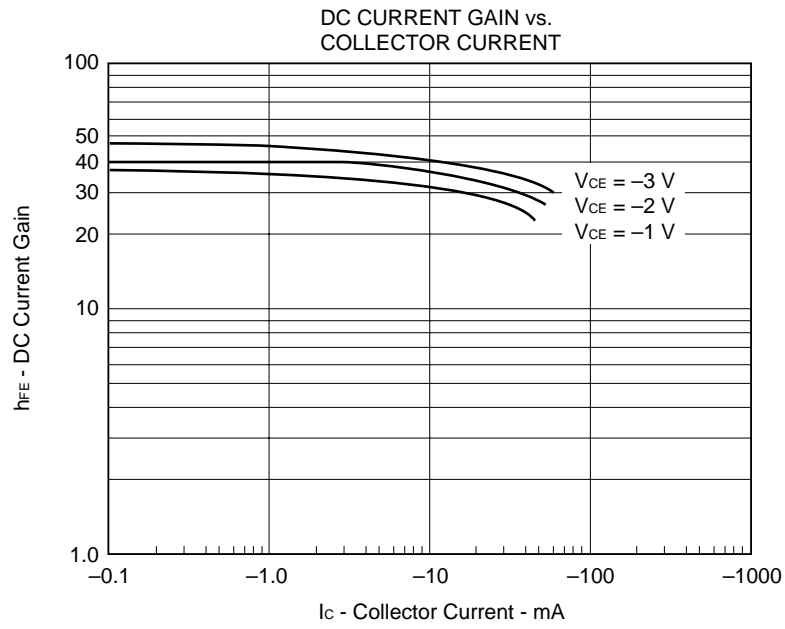

S<sub>11</sub>

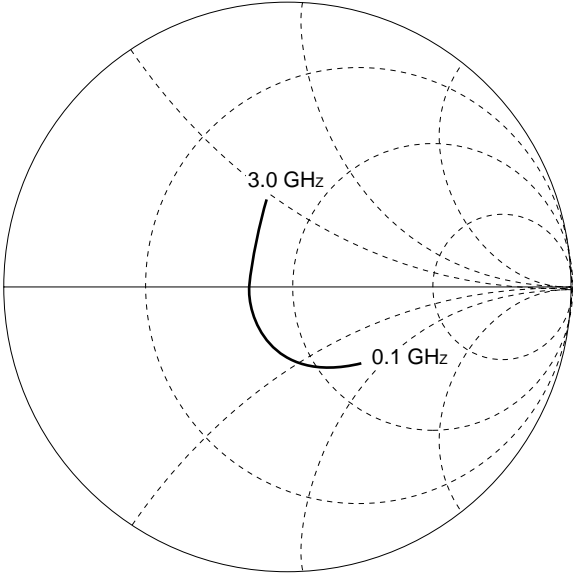

V<sub>CE</sub> = -8 V  
I<sub>c</sub> = -20 mA

S<sub>22</sub>

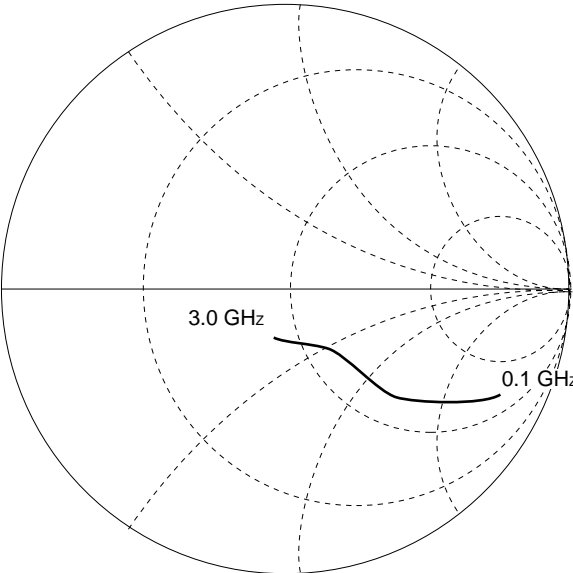

V<sub>CE</sub> = -8 V  
I<sub>c</sub> = -20 mA

S-PARAMETER

( $V_{CE} = 1\text{ V}$ ,  $I_C = 5\text{ mA}$ ,  $Z_o = 50\ \Omega$ )

f MHz	S <sub>11</sub>		S <sub>21</sub>		S <sub>12</sub>		S <sub>22</sub>	
	MAG	ANG	MAG	ANG	MAG	ANG	MAG	ANG
100	0.553	-43.7	11.03	150.	0.423	71.2	0.666	-25.0
200	0.460	-78.2	8.780	129.	0.691	59.4	0.696	-42.2
300	0.427	-104	7.003	115.	0.857	54.4	0.556	-52.9
400	0.393	-123	5.700	105.	0.983	52.7	0.461	-59.5
500	0.377	-138	4.74	97.6	0.109	52.2	0.392	-64.2
600	0.367	-149	4.053	91.2	0.120	52.5	0.341	-67.4
700	0.362	-159	3.549	85.9	0.131	52.9	0.307	-70.5
800	0.363	-168	3.151	61.3	0.143	53.1	0.280	-73.7
900	0.364	-175	2.847	77.0	0.154	53.8	0.258	-76.1
1000	0.365	178	2.603	73.0	0.165	54.0	0.241	-78.8
1100	0.369	172	2.391	69.3	0.176	54.4	0.227	-82.0
1200	0.375	166	2.219	66.8	0.188	54.2	0.217	-84.8
1300	0.376	162	2.070	62.7	0.200	54.4	0.207	-88.4
1400	0.384	157	1.940	59.4	0.213	54.1	0.200	-92.0
1500	0.391	153	1.838	56.3	0.225	53.8	0.192	-94.9
1600	0.399	149	1.744	53.5	0.238	53.4	0.188	-99.1
1700	0.405	146	1.659	50.8	0.250	52.9	0.184	-102
1800	0.411	142	1.584	48.2	0.264	52.3	0.184	-107
1900	0.418	139	1.520	45.6	0.277	51.7	0.182	-111
2000	0.423	135	1.461	43.1	0.290	51.1	0.181	-115
2100	0.429	132	1.408	40.9	0.302	50.2	0.180	-119
2200	0.438	130	1.361	38.6	0.314	49.4	0.182	-125
2300	0.444	127	1.316	36.4	0.328	48.5	0.181	-128
2400	0.450	124	1.276	34.2	0.341	47.6	0.187	-132
2500	0.457	122	1.239	32.3	0.353	46.5	0.188	-137



**S-PARAMETER**

( $V_{CE} = 3\text{ V}$ ,  $I_C = 5\text{ mA}$ ,  $Z_o = 50\ \Omega$ )

f MHz	S <sub>11</sub>		S <sub>21</sub>		S <sub>12</sub>		S <sub>22</sub>	
	MAG	ANG	MAG	ANG	MAG	ANG	MAG	ANG
100	0.595	- 34.2	11.62	154.	0.0328	74.9	0.902	- 19.4
200	0.511	- 62.8	9.618	134.	0.0573	64.8	0.760	- 33.2
300	0.432	- 86.0	7.920	120.	0.0734	58.5	0.633	- 41.9
400	0.362	- 104	6.575	110.	0.0852	57.1	0.542	- 47.3
500	0.345	- 119	5.511	102.	0.0964	55.9	0.471	- 50.3
600	0.323	- 132	4.749	95.9	0.106	56.4	0.420	- 52.2
700	0.308	- 143	4.177	90.5	0.116	56.6	0.383	- 54.1
800	0.300	- 153	3.712	85.8	0.126	57.1	0.355	- 55.7
900	0.297	- 162	3.359	81.5	0.137	57.3	0.332	- 57.2
1000	0.295	- 170	3.064	77.6	0.147	57.9	0.315	- 58.9
1100	0.297	- 177	2.818	74.0	0.158	57.9	0.299	- 60.6
1200	0.300	176	2.617	70.6	0.169	58.3	0.287	- 62.1
1300	0.303	170	2.439	67.4	0.181	58.1	0.276	- 64.6
1400	0.308	164	2.284	64.2	0.192	58.1	0.266	- 66.5
1500	0.314	160	2.159	61.2	0.203	57.8	0.258	- 68.5
1600	0.322	155	2.046	58.4	0.215	57.5	0.250	- 71.4
1700	0.328	151	1.944	55.7	0.227	57.3	0.243	- 73.6
1800	0.335	147	1.855	53.0	0.240	56.5	0.241	- 76.9
1900	0.341	143	1.774	50.5	0.252	56.1	0.233	- 80.3
2000	0.349	140	1.705	48.1	0.264	55.5	0.230	- 83.1
2100	0.355	136	1.638	45.7	0.276	54.7	0.226	- 86.5
2200	0.364	133	1.583	43.5	0.289	54.2	0.222	- 90.7
2300	0.372	130	1.53	41.2	0.302	53.2	0.218	- 93.6
2400	0.378	128	1.479	39.0	0.314	52.5	0.218	- 97.5
2500	0.386	125	1.439	37.0	0.326	51.7	0.215	- 101.

S-PARAMETER

( $V_{CE} = 8\text{ V}$ ,  $I_C = 5\text{ mA}$ ,  $Z_o = 50\ \Omega$ )

f MHz	S <sub>11</sub>		S <sub>21</sub>		S <sub>12</sub>		S <sub>22</sub>	
	MAG	ANG	MAG	ANG	MAG	ANG	MAG	ANG
100	0.679	- 27.6	11.75	156.	0.0289	76.9	0.918	- 15.9
200	0.586	- 51.4	10.01	138.	0.0508	66.6	0.802	- 27.7
300	0.491	- 71.0	8.453	124.	0.0670	61.8	0.690	- 35.3
400	0.417	- 87.3	7.152	114.	0.0780	58.9	0.603	- 39.9
500	0.362	- 100	6.040	106.	0.0886	58.3	0.534	- 42.5
600	0.323	- 113	5.245	99.6	0.0984	57.9	0.485	- 44.0
700	0.293	- 124	4.627	94.2	0.107	58.0	0.448	- 45.5
800	0.274	- 135	4.124	89.4	0.117	58.4	0.419	- 46.6
900	0.261	- 145	3.734	85.0	0.126	58.6	0.396	- 47.7
1000	0.251	- 154	3.419	81.2	0.135	59.4	0.377	- 48.8
1100	0.247	- 162	3.150	77.6	0.145	59.6	0.361	- 50.2
1200	0.245	- 170	2.919	74.2	0.155	59.6	0.350	- 51.4
1300	0.245	- 177	2.720	71.0	0.166	59.8	0.339	- 53.2
1400	0.247	175	2.551	67.8	0.176	59.9	0.327	- 54.6
1500	0.251	169	2.410	64.8	0.187	59.7	0.320	- 56.1
1600	0.258	164	2.283	62.1	0.198	59.5	0.311	- 58.2
1700	0.263	159	2.169	59.3	0.209	59.4	0.305	- 59.8
1800	0.269	154	2.067	56.7	0.221	58.9	0.299	- 62.4
1900	0.276	150	1.977	54.4	0.232	58.6	0.292	- 64.9
2000	0.283	146	1.898	51.8	0.243	58.1	0.287	- 67.0
2100	0.290	142	1.824	49.5	0.256	57.5	0.283	- 69.6
2200	0.298	138	1.762	47.2	0.267	57.0	0.277	- 72.9
2300	0.307	135	1.701	44.9	0.279	56.1	0.272	- 75.1
2400	0.314	132	1.645	42.8	0.291	55.4	0.270	- 78.7
2500	0.321	129	1.597	40.6	0.304	54.7	0.264	- 81.3

**S-PARAMETER**

( $V_{CE} = 8\text{ V}$ ,  $I_C = 20\text{ mA}$ ,  $Z_o = 50\ \Omega$ )

f MHz	S <sub>11</sub>		S <sub>21</sub>		S <sub>12</sub>		S <sub>22</sub>	
	MAG	ANG	MAG	ANG	MAG	ANG	MAG	ANG
100	0.310	- 47.6	20.39	144.	0.0218	77.0	0.798	- 25.2
200	0.243	- 82.1	14.87	123.	0.0375	72.7	0.611	- 37.8
300	0.205	- 107	11.25	111.	0.0514	71.4	0.488	- 43.1
400	0.165	- 125	8.95	102.	0.0643	71.6	0.417	- 45.1
500	0.172	- 140	7.329	96.6	0.0777	71.5	0.365	- 45.7
600	0.169	- 153	6.232	91.6	0.0909	71.5	0.331	- 45.8
700	0.166	- 163	5.414	87.5	0.104	71.0	0.308	- 46.5
800	0.169	- 173	4.778	83.5	0.117	70.6	0.289	- 47.3
900	0.172	179	4.3	80.2	0.130	70.0	0.274	- 47.9
1000	0.176	172	3.902	77.1	0.143	69.3	0.262	- 49.1
1100	0.182	166	3.576	74.1	0.156	68.6	0.251	- 50.4
1200	0.188	160	3.310	71.2	0.169	67.7	0.244	- 51.5
1300	0.194	156	3.080	68.7	0.182	66.7	0.235	- 53.7
1400	0.202	151	2.875	66.0	0.195	66.0	0.227	- 55.6
1500	0.209	147	2.711	63.4	0.208	64.9	0.221	- 57.0
1600	0.217	144	2.564	61.0	0.221	63.9	0.213	- 59.5
1700	0.224	140	2.431	58.6	0.234	62.8	0.209	- 61.7
1800	0.233	137	2.315	56.4	0.247	61.7	0.204	- 64.7
1900	0.240	134	2.212	54.2	0.259	60.8	0.197	- 67.9
2000	0.247	132	2.123	52.0	0.272	59.8	0.193	- 70.0
2100	0.255	129	2.037	49.8	0.284	58.3	0.188	- 73.3
2200	0.263	126	1.965	47.7	0.296	57.2	0.183	- 77.5
2300	0.272	124	1.896	45.7	0.309	56.1	0.179	- 80.1
2400	0.278	122	1.833	43.7	0.321	54.8	0.177	- 84.0
2500	0.286	120	1.778	41.7	0.332	53.7	0.171	- 87.7

No part of this document may be copied or reproduced in any form or by any means without the prior written consent of NEC Corporation. NEC Corporation assumes no responsibility for any errors which may appear in this document.

NEC Corporation does not assume any liability for infringement of patents, copyrights or other intellectual property rights of third parties by or arising from use of a device described herein or any other liability arising from use of such device. No license, either express, implied or otherwise, is granted under any patents, copyrights or other intellectual property rights of NEC Corporation or others.

While NEC Corporation has been making continuous effort to enhance the reliability of its semiconductor devices, the possibility of defects cannot be eliminated entirely. To minimize risks of damage or injury to persons or property arising from a defect in an NEC semiconductor device, customer must incorporate sufficient safety measures in its design, such as redundancy, fire-containment, and anti-failure features.

NEC devices are classified into the following three quality grades:

“Standard”, “Special”, and “Specific”. The Specific quality grade applies only to devices developed based on a customer designated "quality assurance program" for a specific application. The recommended applications of a device depend on its quality grade, as indicated below. Customers must check the quality grade of each device before using it in a particular application.

Standard : Computers, office equipment, communications equipment, test and measurement equipment, audio and visual equipment, home electronic appliances, machine tools, personal electronic equipment and industrial robots

Special: Transportation equipment (automobiles, trains, ships, etc.), traffic control systems, anti-disaster systems, anti-crime systems, safety equipment and medical equipment (not specifically designed for life support)

Specific: Aircrafts, aerospace equipment, submersible repeaters, nuclear reactor control systems, life support systems or medical equipment for life support, etc.

The quality grade of NEC devices in “Standard” unless otherwise specified in NEC's Data Sheets or Data Books.

If customers intend to use NEC devices for applications other than those specified for Standard quality grade, they should contact NEC Sales Representative in advance.

Anti-radioactive design is not implemented in this product.