

2SA1619, 2SA1619A

Silicon PNP epitaxial planer type

For low-frequency power amplification and driver amplification
Complementary to 2SC4208 and 2SC4208A

■ Features

- Complementary pair with 2SC4208 and 2SC4208A.
- Allowing supply with the radial taping and automatic insertion possible.

■ Absolute Maximum Ratings (Ta=25°C)

Parameter	Symbol	Ratings	Unit
Collector to base voltage	2SA1619	-30	V
	2SA1619A	-60	
Collector to emitter voltage	2SA1619	-25	V
	2SA1619A	-50	
Emitter to base voltage	V _{EBO}	-5	V
Peak collector current	I _{CP}	-1	A
Collector current	I _C	-0.5	A
Collector power dissipation	P _C	1	W
Junction temperature	T _j	150	°C
Storage temperature	T _{stg}	-55 ~ +150	°C

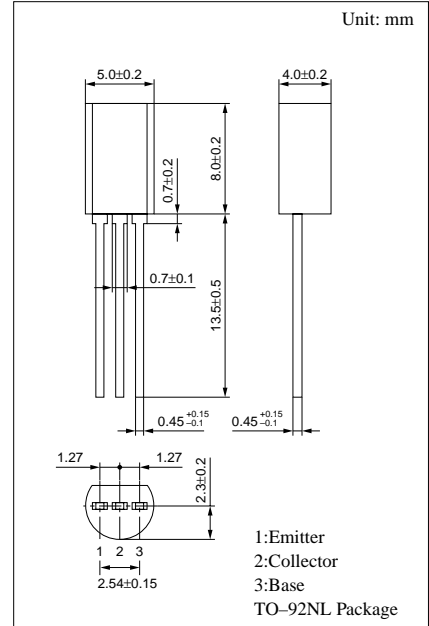

■ Electrical Characteristics (Ta=25°C)

Parameter	Symbol	Conditions	min	typ	max	Unit
Collector cutoff current	I _{CBO}	V _{CB} = -20V, I _E = 0			-0.1	μA
Collector to base voltage	2SA1619	I _C = -10μA, I _E = 0	-30			V
	2SA1619A		-60			
Collector to emitter voltage	2SA1619	I _C = -10mA, I _B = 0	-25			V
	2SA1619A		-50			
Emitter to base voltage	V _{EBO}	I _E = -10μA, I _C = 0	-5			V
Forward current transfer ratio	h _{FE1} *	V _{CE} = -10V, I _C = -150mA	85	160	340	
	h _{FE2}	V _{CE} = -10V, I _C = -500mA	40			
Collector to emitter saturation voltage	V _{CE(sat)}	I _C = -300mA, I _B = -30mA		-0.35	-0.6	V
Base to emitter saturation voltage	V _{BE(sat)}	I _C = -300mA, I _B = -30mA		-1.1	-1.5	V
Transition frequency	f _T	V _{CB} = -10V, I _E = 50mA, f = 200MHz		200		MHz
Collector output capacitance	C _{ob}	V _{CB} = -10V, I _E = 0, f = 1MHz		6	15	pF

*h_{FE1} Rank classification

Rank	Q	R	S
h _{FE1}	85 ~ 170	120 ~ 240	170 ~ 340

$P_C - T_a$

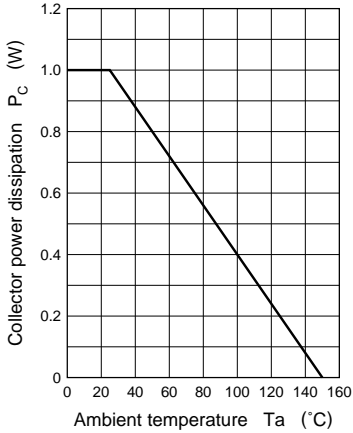

$I_C - V_{CE}$

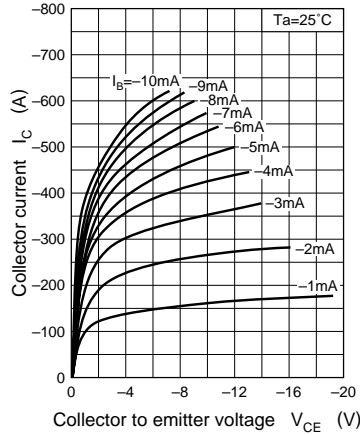

$I_C - I_B$

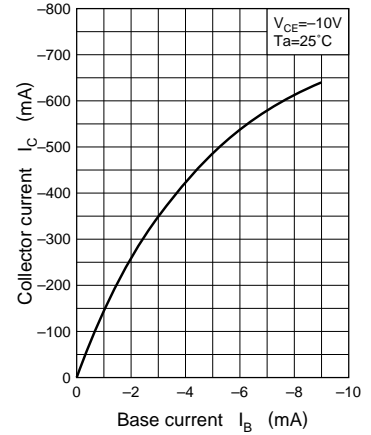

$V_{CE(sat)} - I_C$

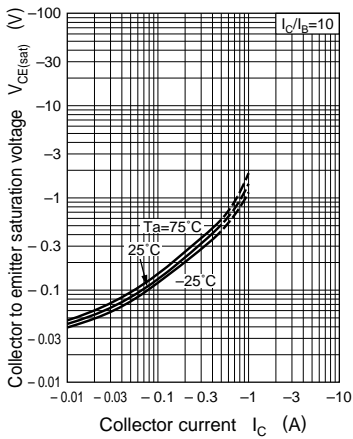

$V_{BE(sat)} - I_C$

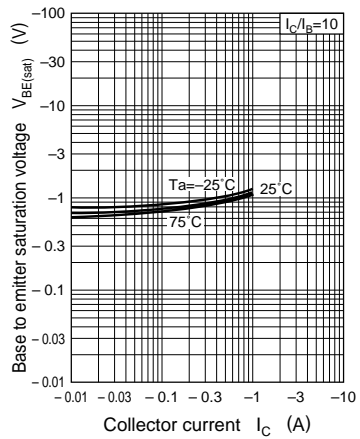

$h_{FE} - I_C$

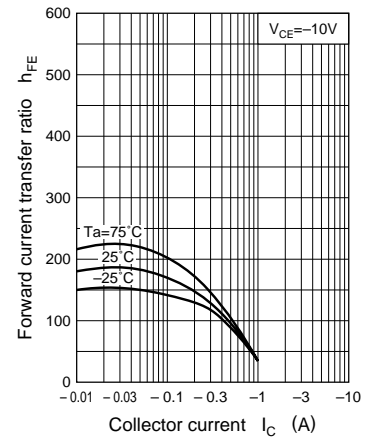

$f_T - I_E$

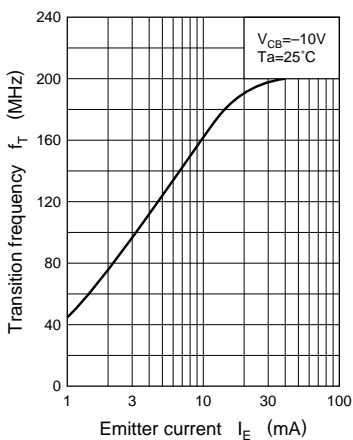

$C_{ob} - V_{CB}$

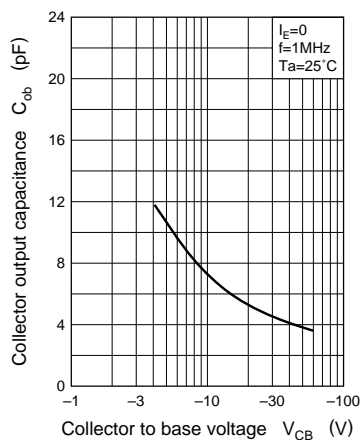

$V_{CER} - R_{BE}$

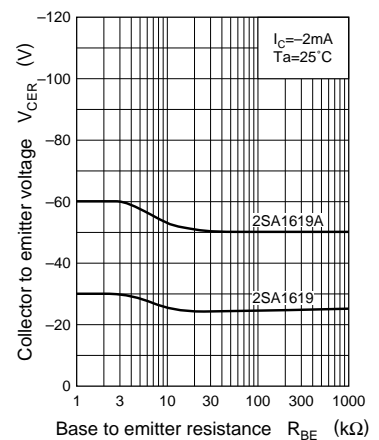

$I_{CEO} - T_a$

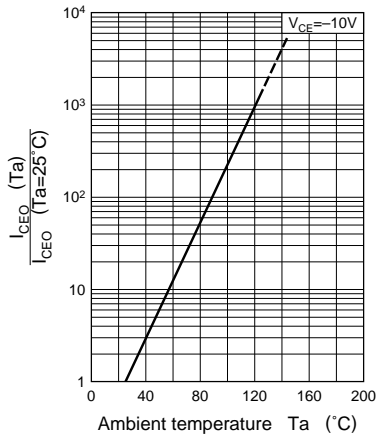

Area of safe operation (ASO)

