

## PUTs

Military, Planar, TO-18, Hermetic

T-25-09

## FEATURES

- Available as JAN and JANTX types per MIL standard 19500/493
- $-55^{\circ}\text{C}$  to  $+125^{\circ}\text{C}$  Temperature Range for Timing and Oscillator Circuits
- $I_p \leq 10\mu\text{A}$  at  $T = -55^{\circ}\text{C}$   
 $I_p \geq 40\mu\text{A}$  at  $T = +125^{\circ}\text{C}$
- Programmable  $\eta$ ,  $R_{\text{ON}}$ ,  $I_p$ , and  $I_V$
- Peak Recurrent Current: of 5A
- Low On-State Voltage Drop
- Hermetically Sealed Metal Case and Planar Passivated Construction for Maximum Reliability and Parameter Stability.

## DESCRIPTION

The Programmable Unijunction Transistor is functionally equivalent to a standard unijunction transistor with the advantage that external resistors can be used to program  $\eta$ ,  $R_{\text{ON}}$ ,  $I_p$ , and  $I_V$ , depending upon the designer's needs. The Unijunction device, in addition to allowing programmable versatility, is completely planar passivated and packaged in a TO-18 hermetically sealed package, which offers an order of magnitude improvement in inherent reliability over many similar devices. Applications include pulse and timing circuits, SCR trigger circuits, relaxation oscillators, and sensing circuits. For further application information see Unijunction Application Note U-66.

## ABSOLUTE MAXIMUM RATINGS

Anode-to-Cathode Forward Voltage, $V_{AK}$	40V
Anode-to-Cathode Reverse Voltage, $V_{AKR}$	40V
Gate-to-Cathode Forward Voltage, $V_{GK}$	40V
Gate-to-Anode Reverse Voltage, $V_{GAR}$	40V
Gate-to-Cathode Reverse Voltage, $V_{GKR}$	5V
Peak Recurrent Forward Current, $10\mu\text{s}$ 1% Duty Cycle	5A
Peak Gate Current, $I_{GM}$	250mA
Average Gate Current, $I_{G(AV)}$	50mA
Power Dissipation	
$25^{\circ}\text{C}$ Ambient	300mW
Derating Factor	2.4mW/ $^{\circ}\text{C}$
Storage Temperature Range	$-55^{\circ}\text{C}$ to $+125^{\circ}\text{C}$
Operating Temperature Range	$-55^{\circ}\text{C}$ to $+125^{\circ}\text{C}$

## MECHANICAL SPECIFICATIONS

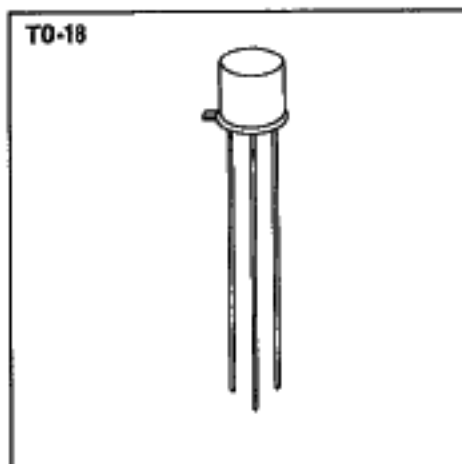
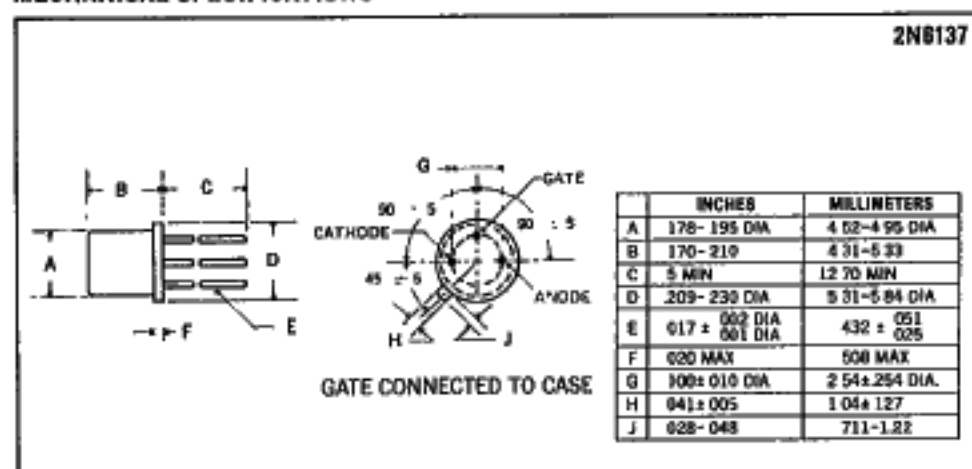

## ELECTRICAL SPECIFICATIONS (at 25°C unless noted)†

Test	Symbol	Figure	Minimum	Typical	Maximum	Units	Test Conditions
SUBGROUP 1 Visual and Mechanical	—	—	—	—	—	—	<b>T-25-09</b>
SUBGROUP 2							
Gate-anode blocking current	$I_{GAD}$	2	—	2	10	nA	$V_{GA} = \text{Rating}$
Gate-cathode blocking current	$I_{GKS}$	3	—	5	100	nA	$V_{GK} = \text{Rating}$
SUBGROUP 3							
Peak-point anode current	$I_p$	1	—	1 2.5	2 5	$\mu\text{A}$	$R_G = 1 \text{ Meg} / \left. \begin{array}{l} R_G = 10\text{K} \\ R_G = 10\text{K} \end{array} \right\} V_s = 10\text{V}$
Peak-point offset voltage	$V_T$	1	0.2 0.2	0.26 0.35	1.6 0.6	V	
Valley-point anode current	$I_V$	1	— 70 1.5	15 200 2	50 — —	$\mu\text{A}$ $\mu\text{A}$ mA	$R_G = 1 \text{ Meg} / \left. \begin{array}{l} R_G = 10\text{K} \\ R_G = 200\Omega \end{array} \right\} V_s = 10\text{V}$
SUBGROUP 4							
Forward on-state voltage	$V_F$	4	—	0.85	1.0	V	$I_s = 50\text{mA}$
Peak pulse voltage	$V_o$	5	9	12	—	V	
Peak pulse voltage rise time	$t_r$	5	—	50	80	ns	
SUBGROUP 5							
Gate-anode blocking current (125°C Test)	$I_{GAD}$	2	—	150	500	nA	$V_{GA} = \text{Rating}$
Valley-point anode current (125°C Test)	$I_V$	1	40	100	—	$\mu\text{A}$	$R_G = 10\text{K}, V_s = 10\text{V}$
Peak-point anode current (-55°C Test)	$I_p$	1	—	7.5	10	$\mu\text{A}$	$R_G = 10\text{K}, V_s = 10\text{V}$

† All values in table are JEDEC registered

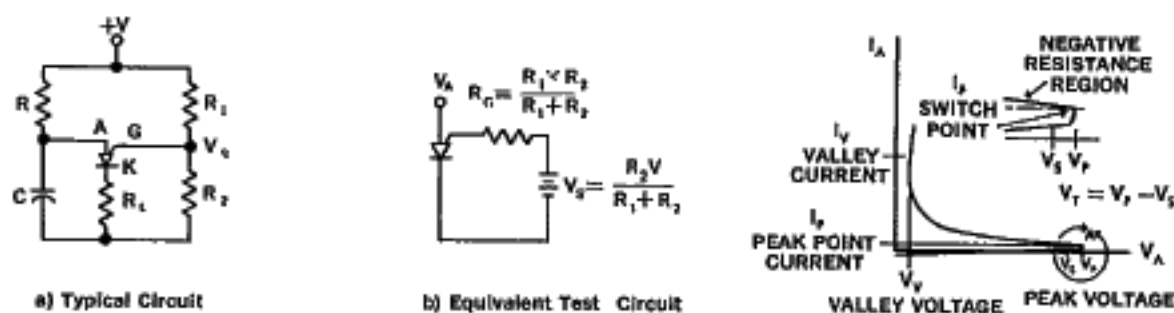

Figure 1

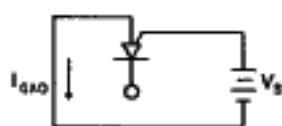

Figure 2

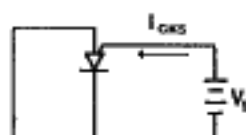

Figure 3

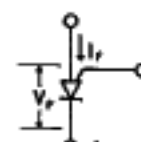

Figure 4

Notes: Conditions for oscillation

$$\frac{V_{GS} - V_F}{R} > I_p$$

$$\frac{V_{GS} - V_F}{R} < I_V$$

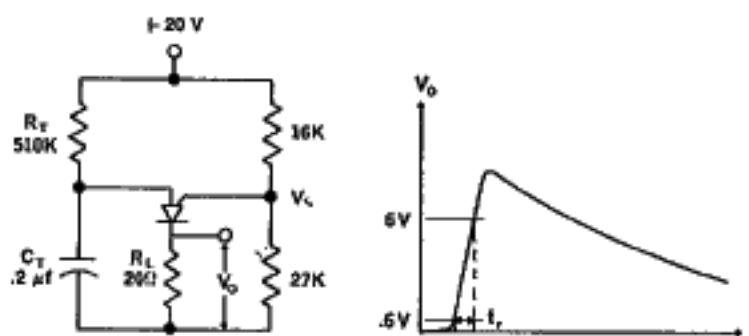
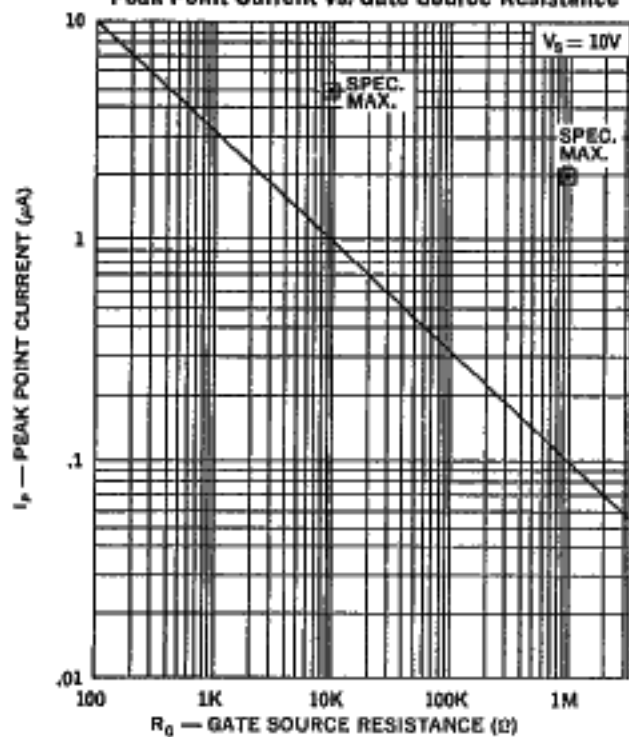

Figure 5

T-25-09

Peak Point Current vs. Gate Source Resistance



Peak Point Current vs. Ambient Temperature

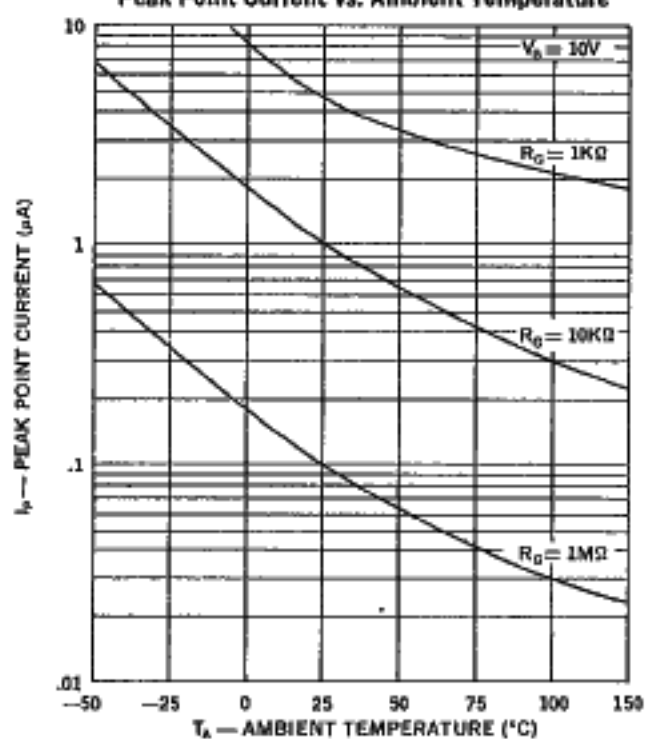

Valley Current vs. Gate Current

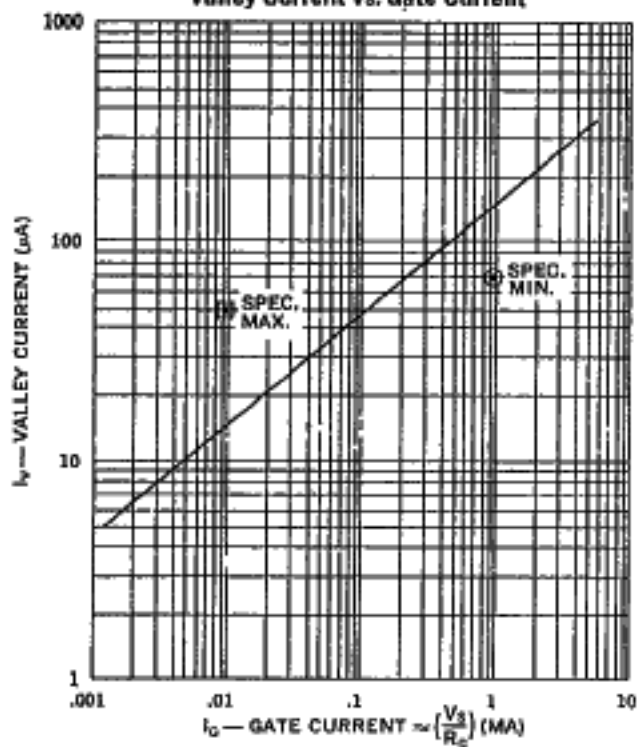

Valley Current vs. Ambient Temperature

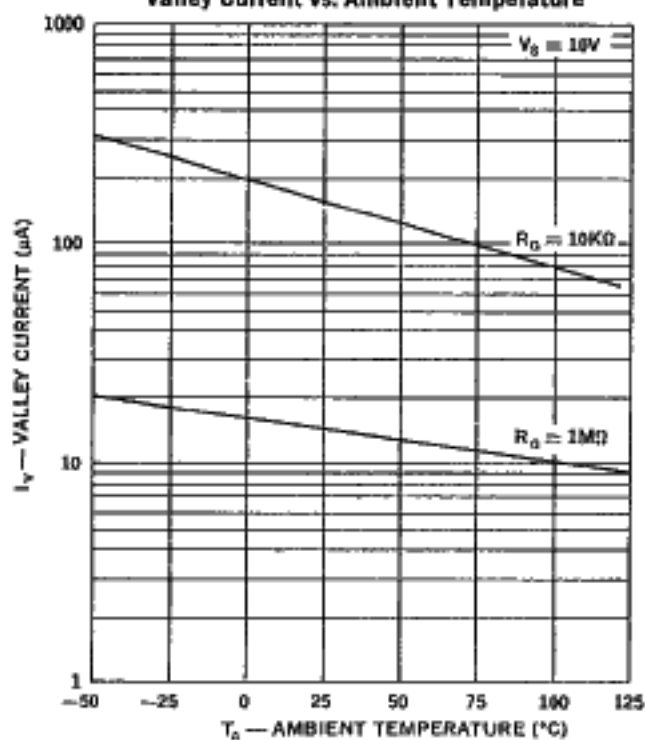

T-25-09

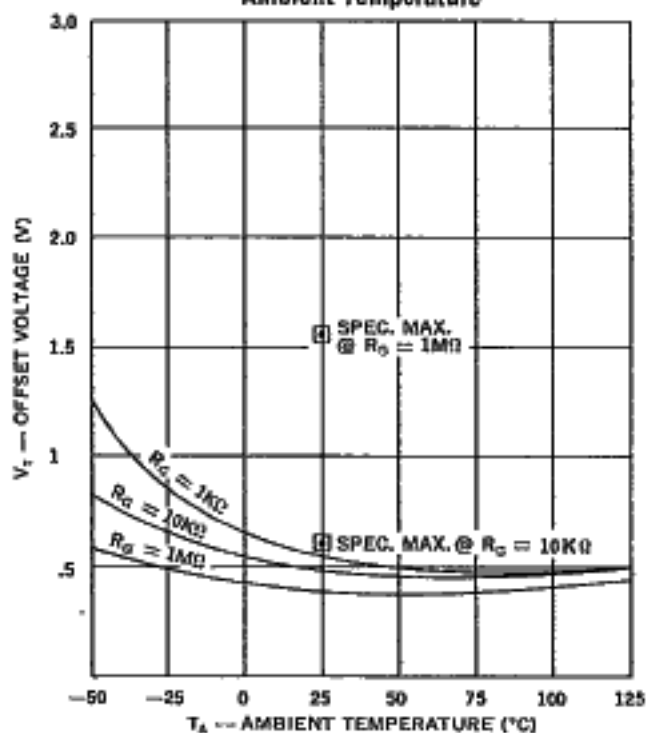
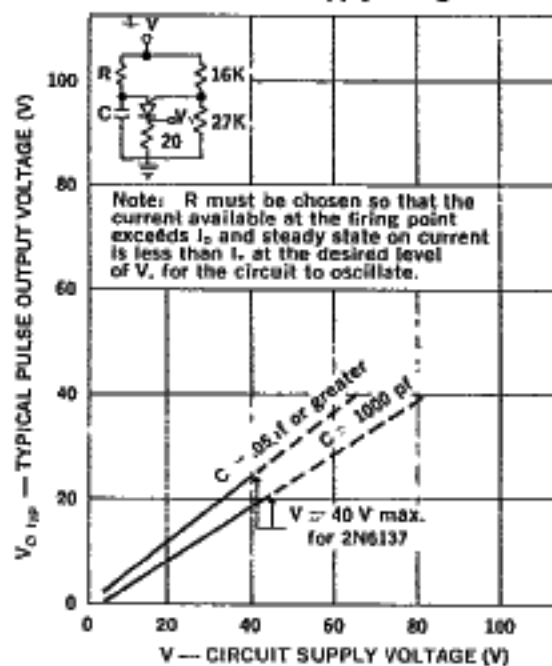
Offset Voltage vs.  
Ambient TemperatureTypical Pulse Output Voltage vs.  
Circuit Supply Voltage

Typical Current vs. On-State Voltage

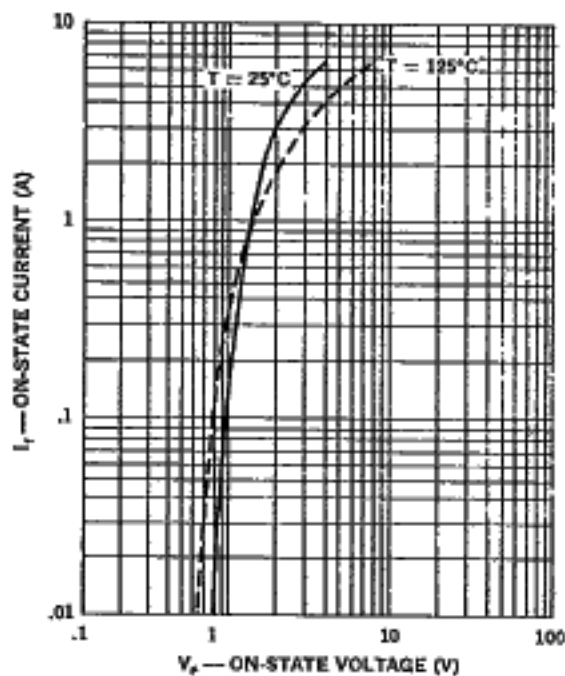
Gate-Anode Blocking Current vs.  
Ambient Temperature