

2N6032, 2N6033

File Number 462

## High-Current, High-Speed High-Power Transistors

Silicon N-P-N Types for High-Speed Switching and Linear-Amplifier Applications in Military, Industrial and Commercial Equipment

**Features:**

- Low  $V_{ce(sat)}=1$  V max. at 40 A, 1.3 V max. at 50 A
- Maximum safe-area-of-operation curves  
 $I_{B/Ic}$  limit line beginning at 24 V
- Fast storage time:  
 $t_s=1.5\mu s$  max. at  $I_c=40$  A (2N6033), 50 A (2N6032)

**TERMINAL DESIGNATIONS**

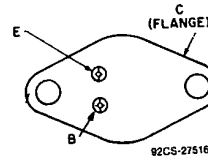

JEDEC TO-204AE

The RCA-2N6032 and 2N6033\* are epitaxial silicon n-p-n transistors having high-current and high-power handling capability and fast switching speed. The 2N6033 is similar to the 2N6032; they differ in maximum values for continuous collector current and sustaining voltage.

They are supplied in the JEDEC TO-204AE hermetic steel package with 0.060-inch diameter pins.

\*Formerly RCA Dev. Types TA7337 and TA7337A, respectively.

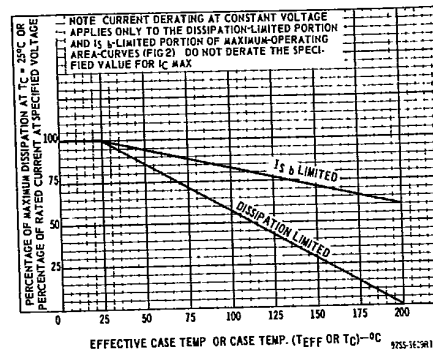

Fig. 1 - Derating curves for both types.

**MAXIMUM RATINGS, Absolute-Maximum Values:**

	2N6032	2N6033	
• COLLECTOR-TO-BASE VOLTAGE, $V_{cbo}$ .....	120	150	V
COLLECTOR-TO-EMITTER SUSTAINING VOLTAGE:			
With base open, $V_{ceo(sus)}$ .....	90	120	V
With external base-to-emitter resistance ( $R_{BE} \leq 50 \Omega$ ), $V_{cer(sus)}$ .....	110	140	V
• With external base-to-emitter resistance ( $R_{BE} \leq 50 \Omega$ & $V_{BE} = -1.5$ V, $V_{ce(sus)}$ .....	120	150	V
• EMITTER-TO-BASE VOLTAGE, $V_{EBO}$ .....	7	7	V
• CONTINUOUS COLLECTOR CURRENT, $I_c$ .....	50	40	A
• BASE CURRENT, $I_B$ .....	10	10	A
• EMITTER CURRENT, $I_E$ .....	50	40	A
• TRANSISTOR DISSIPATION, $P_T$ :			
At case temperatures up to 25°C and $V_{CE}$ up to 24 V .....	140	140	W
At case temperatures up to 25°C and $V_{CE}$ above 24 V .....	See Fig. 2		
At case temperatures above 25°C and $V_{CE}$ above 24 V .....	See Figs. 2 & 3		
• TEMPERATURE RANGE:			
Storage & Operating (Junction) .....	-65 to +200		°C
• PIN TEMPERATURE (During Soldering):			
At distance $\geq 1/32$ in. (0.8 mm) from seating plane for 10 s max. ....	230		°C

\*In accordance with JEDEC registration data format (JS-6 RDF-1).

2N6032, 2N6033

ELECTRICAL CHARACTERISTICS, Case Temperature (T<sub>C</sub>) = 25°C Unless Otherwise Specified

CHARACTERISTIC	SYMBOL	TEST CONDITIONS							LIMITS				UNITS
		DC Collector Voltage (V)		DC Emitter or Base Voltage (V)		DC Current (A)			Type 2N6032		Type 2N6033		
		V <sub>CB</sub>	V <sub>CE</sub>	V <sub>EB</sub>	V <sub>BE</sub>	I <sub>C</sub>	I <sub>E</sub>	I <sub>B</sub>	Min.	Max.	Min.	Max.	
Collector-Cutoff Current: With base open	I <sub>CEO</sub>	-	80	-	-	-	-	0	-	10	-	10	mA
* With base-emitter junction reverse biased (T <sub>C</sub> = 150°C)	I <sub>CEV</sub>	-	110	-	-1.5	-	-	-	-	12	-	-	mA
		-	135	-	-1.5	-	-	-	-	-	-	10	mA
		-	100	-	-1.5	-	-	-	-	15	-	10	mA
* Emitter-Cutoff Current	I <sub>EBO</sub>	-	-	7	-	0	-	-	-	10	-	10	mA
Collector-to-Emitter Sustaining Voltage: (See Figs. 12 & 13) With base open	V <sub>CEO(sus)</sub>	-	-	-	-	0.2	-	0	90 <sup>a</sup>	-	120 <sup>a</sup>	-	V
With external base to emitter resistance (R <sub>BE</sub> ) ≤ 50 Ω	V <sub>CER(sus)</sub>	-	-	-	-	0.2	-	0	110 <sup>a</sup>	-	140 <sup>a</sup>	-	
With base-emitter junction reverse biased & R <sub>BE</sub> ≤ 50 Ω	V <sub>CEX(sus)</sub>	-	-	-	-1.5	0.2	-	0	120 <sup>a</sup>	-	150 <sup>a</sup>	-	
* Base-to-Emitter Saturation Voltage <sup>c</sup>	V <sub>BE(sat)</sub>	-	-	-	-	50 40	-	5 4	-	2 -	-	2 -	V
Base-to-Emitter Voltage	V <sub>BE</sub>	-	2 2	-	-	50 40	-	-	-	2 -	-	2 -	V
* Collector-to-Emitter Saturation Voltage <sup>c</sup>	V <sub>CE(sat)</sub>	-	-	-	-	50 40	-	5 4	-	1.3 -	-	1 -	V
* DC Forward-Current Transfer Ratio <sup>c</sup>	h <sub>FE</sub>	-	2.6 2	-	-	50 40	-	-	10 -	50 -	-	10 50	
Second-Breakdown Collector Current With base forward biased	I <sub>S/b</sub> <sup>b</sup>	-	24 40	-	-	-	-	-	-	5.8 <sup>c</sup> 0.9 <sup>c</sup>	-	5.8 <sup>c</sup> 0.9 <sup>c</sup>	A
* Magnitude of common-emitter small-signal, short-circuit, forward-current transfer ratio (at 5 MHz)	h <sub>fe</sub>	-	10	-	-	2	-	-	10	-	10	-	
Gain-Bandwidth Product	f <sub>T</sub>	-	10	-	-	2	-	-	50	-	50	-	MHz
Output Capacitance (at 1 MHz)	C <sub>obo</sub>	10	-	-	-	-	0	-	-	800	-	800	pF
Saturated Switching Time: Turn-On (Delay Time + Rise Time)	t <sub>on</sub>	V <sub>CC</sub> = 30V	-	-	-	50 40	-	5 <sup>e</sup> 4 <sup>e</sup>	-	1 -	-	1 -	μs
* Rise	t <sub>r</sub>	V <sub>CC</sub> = 30V	-	-	-	50 40	-	5 <sup>e</sup> 4 <sup>e</sup>	-	1 -	-	1 -	μs
* Storage	t <sub>s</sub>	V <sub>CC</sub> = 30V	-	-	-	50 40	-	5 <sup>e</sup> 4 <sup>e</sup>	-	1.5 -	-	1.5 -	μs
* Fall	t <sub>f</sub>	V <sub>CC</sub> = 30V	-	-	-	50 40	-	5 <sup>e</sup> 4 <sup>e</sup>	-	0.5 -	-	0.5 -	μs
Thermal Resistance (Junction-to-Case)	θ <sub>J-C</sub>	-	20	-	-	2.5	-	-	-	1.25	-	1.25	°C/W

<sup>a</sup> CAUTION: The sustaining voltages V<sub>CEO(sus)</sub>, V<sub>CER(sus)</sub>, and V<sub>CEX(sus)</sub> MUST NOT be measured on a curve tracer.

<sup>b</sup> I<sub>S/b</sub> is defined as the current at which second breakdown occurs at a specified collector voltage with the emitter-base junction forward biased for transistor operation in the active region.

<sup>c</sup> Pulsed; 1-s, non-repetitive pulse.

<sup>e</sup> I<sub>B1</sub> = I<sub>B2</sub> \*In accordance with JEDEC registration format JS-6 RDF-1.

2N6032, 2N6033

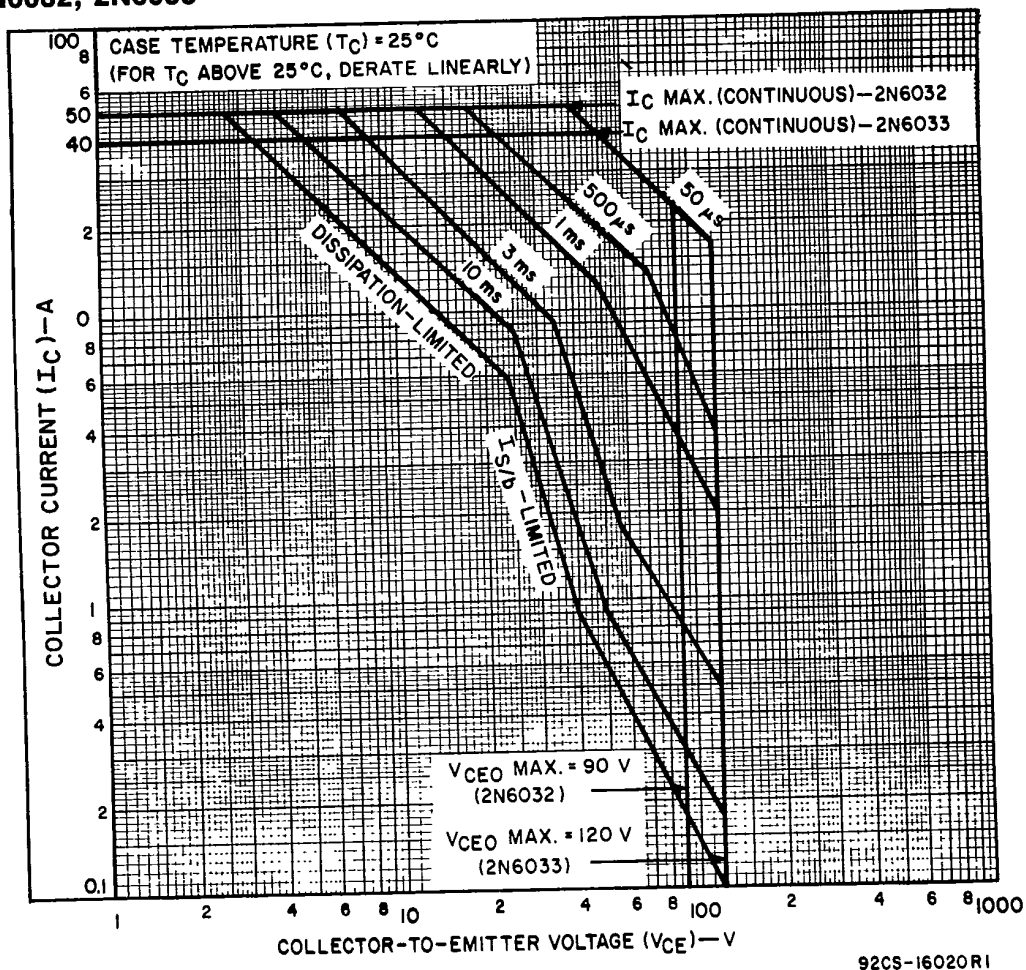

Fig. 2 - Maximum operating area for both types.

2N6032, 2N6033

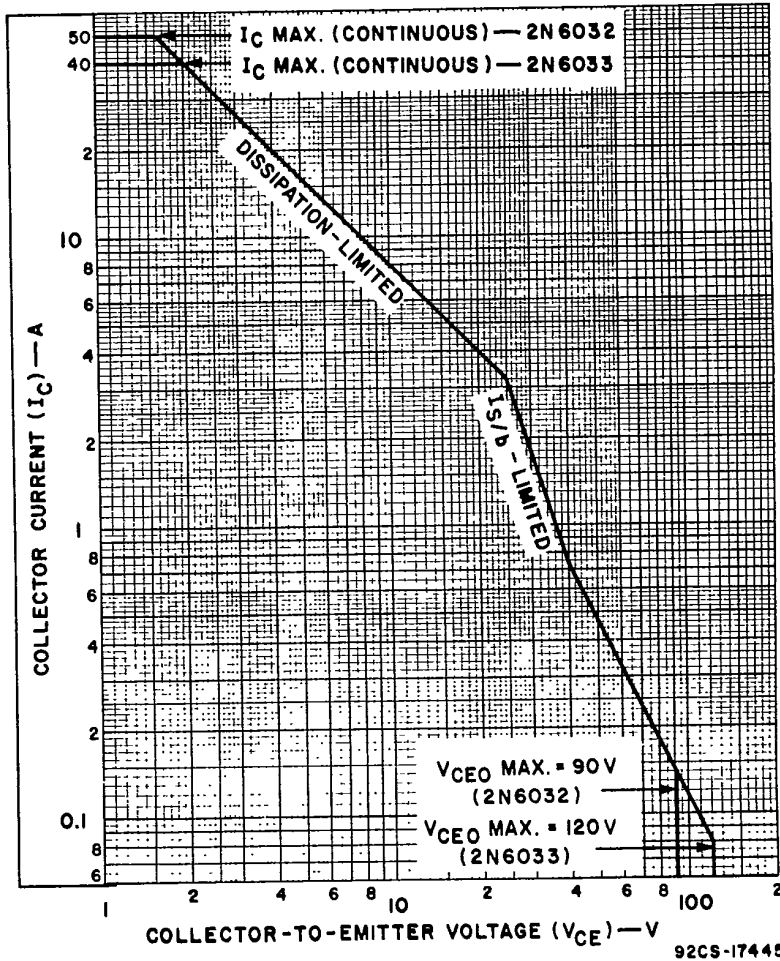

Fig. 3 - Maximum operating areas for both types at case temperature ( $T_c$ ) = 100°C.

2N6032, 2N6033

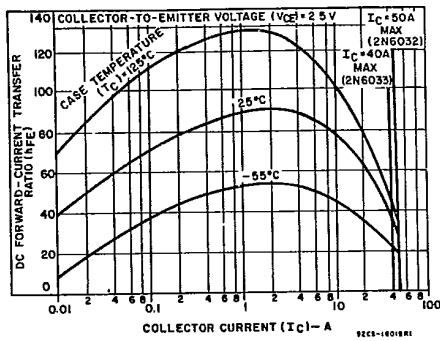

Fig. 4 - Typical dc-beta characteristics for both types.

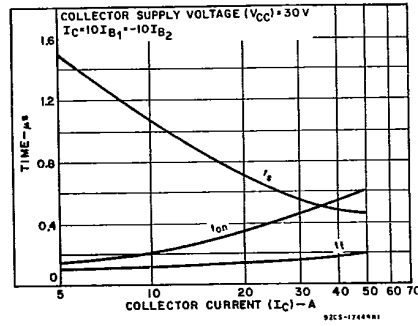

Fig. 5 - Typical saturated switching characteristics for both types.

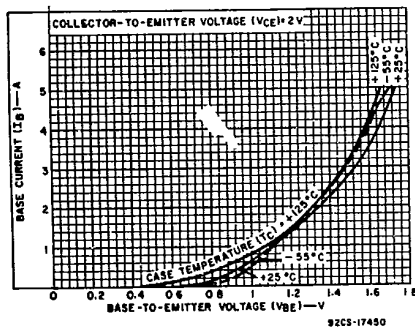

Fig. 6 - Typical input characteristics for both types.

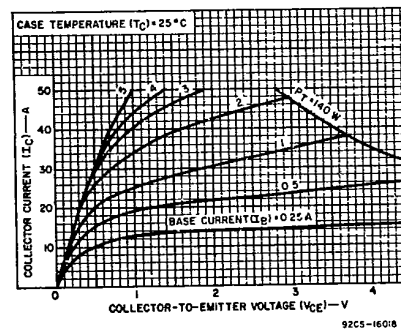

Fig. 7 - Typical collector characteristics for both types.

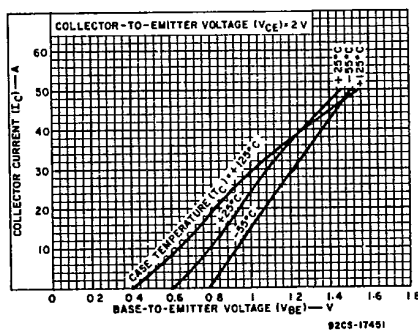

Fig. 8 - Typical transfer characteristics for both types.

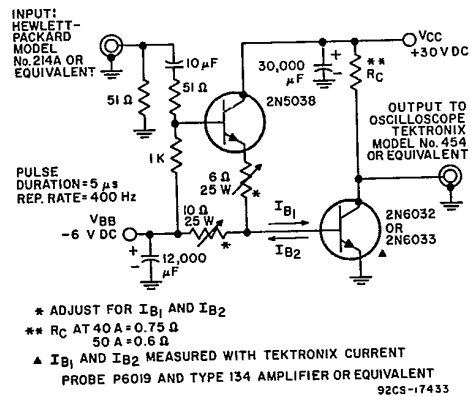

Fig. 9 - Switching-time test set.