

International IR Rectifier

19MT050XF

"FULL-BRIDGE" FREDFET MTP

HEXFET® Power MOSFET

Features

- Low On-Resistance
- High Performance Optimised Built-in Fast Recovery Diodes
- Fully Characterized Capacitance and Avalanche Voltage and Current
- Aluminum Nitride DBC
- Very Low Stray Inductance Design for High Speed Operation

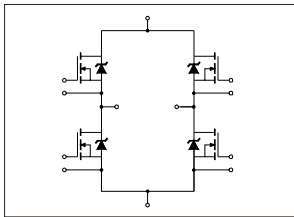

31 A
 $V_{DSS} = 500V$

Benefits

- Low Gate Charge Qg results in Simple Drive Requirement
- Improved Gate, Avalanche and Dynamic dv/dt Ruggedness
- Low Trr and Soft Diode Reverse Recovery
- Optimized for Welding, UPS and SMPS Applications
- Outstanding ZVS and High Frequency Operation
- Direct Mounting to Heatsink
- PCB Solderable Terminals
- Very Low Junction-to-Case Thermal Resistance
- UL Approved E78996

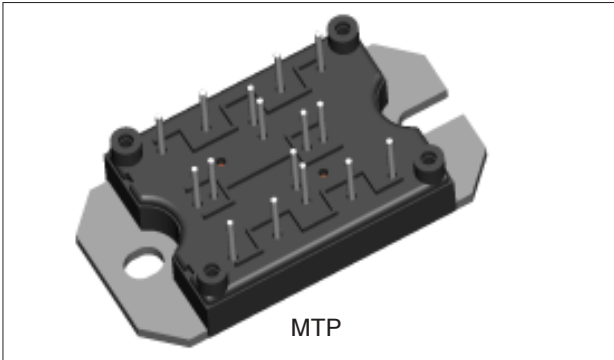

Absolute Maximum Ratings

Parameters		Max	Units
I _D	Continuous Drain Current @ V _{GS} = 10V	@ T _C = 25°C	31
		@ T _C = 100°C	19
I _{DM}	Pulsed Drain Current (1)	124	A
P _D	Maximum Power Dissipation	@ T _C = 25°C	1140
		@ T _C = 100°C	456
V _{GS}	Gate-to-Source Voltage	± 30	V
V _{ISOL}	RMS Isolation Voltage, Any Terminal to Case, t = 1 min	2500	
dv/dt	Peak Diode Recovery dv/dt (3)	15	V/ ns

Electrical Characteristics @ T_J = 25°C (unless otherwise specified)

Parameters	Min	Typ	Max	Units	Test Conditions
V _{(BR)DSS} Drain-to-Source Breakdown Voltage	500			V	V _{GS} = 0V, I _D = 250μA
ΔV _{(BR)DSS} /ΔT _J Temperature Coeff. of Breakdown Voltage		0.48		V/°C	I _D = 4mA, reference to T _J = 25°C
R _{DS(ON)} Static Drain-to-Source On-Resistance		0.19	0.22	Ω	V _{GS} = 10V, I _D = 19A (4)
		0.21	0.25		V _{GS} = 10V, I _D = 31A
V _{GS(th)} Gate Threshold Voltage	3.0		6.0	V	V _{DS} = V _{GS} , I _D = 250μA
I _{DSS} Drain-to-Source Leakage Current (6)			50	μA	V _{DS} = 500V, V _{GS} = 0V
			2	mA	V _{DS} = 400V, V _{GS} = 0V, T _J = 125°C
I _{GSS} Gate-to-Source Forward Leakage			150	nA	V _{GS} = 30V
Gate-to-Source Reverse Leakage			-150		V _{GS} = -30V

Dynamic Characteristics @ T_J = 25°C (unless otherwise specified)

Parameters	Min	Typ	Max	Units	Test Conditions
g _{fs} Forward Transconductance		26		S	V _{DS} = 50V, I _D = 19A
Q _g Total Gate Charge		105	160	nC	I _D = 31A
Q _{gs} Gate-to-Source Charge		36	55		V _{DS} = 400V
Q _{gd} Gate-to-Drain ("Miller") Charge		46	70		V _{GS} = 10V (4)
t _{d(on)} Turn-on Delay Time		49	74	ns	I _D = 31A
t _{d(off)} Turn-off Delay Time		80	120		V _{DS} = 250V
t _r Rise Time		165	250		V _{GS} = 10V
t _f Fall Time		76	115		R _G = 4.3Ω
C _{iSS} Input Capacitance		4808	7210	pF	V _{GS} = 0V
C _{oSS} Output Capacitance		1165	1750		V _{DS} = 25V
C _{rSS} Reverse Transfer Capacitance		40	60		f = 1.0 MHz

Diode Characteristics @ T_J = 25°C (unless otherwise specified)

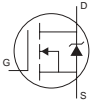
Parameters	Min	Typ	Max	Units	Test Conditions
I _S Continuous Source Current (Body Diode)			31	A	MOSFET symbol showing the integral reverse p-n junction diode 
I _{SM} Pulsed Source Current (Body Diode) (1)			124		
V _{SD} Diode Forward Voltage		1.01	1.1	V	T _J = 25°C, I _S = 31A, V _{GS} = 0V (4)
t _{rr} Reverse Recovery Time		252	378	ns	T _J = 125°C, I _F = 31A
Q _{rr} Reverse Recovery Charge		1619	2428	nC	di/dt = 100A/μs (4)

Avalanche Characteristics

	Parameters	Min	Typ	Max	Units
E_{AS}	Single Pulse Avalanche Energy (2)			493	mJ
I_{AR}	Avalanche Current (1)			31	A
E_{AR}	Repetitive Avalanche Energy (1)			114	mJ

Thermal- Mechanical Specifications

	Parameters	Min	Typ	Max	Units
T_J	Operating Junction Temperature Range	- 40		150	°C
T_{STG}	Storage Temperature Range	- 40		125	
R_{thJC}	Junction-to-Case (per MOSFET)			0.44	°C/ W
R_{thCS}	Case-to-Sink (Heatsink Compound Thermal Conductivity = 1 W/mK)		0.06		
	Clearance ⁽⁵⁾ (external shortest distance in air between two terminals)	5.5			mm
	Creepage ⁽⁵⁾ (shortest distance along external surface of the insulating material between 2 terminals)	8			
	Weight		66		g

Notes:

- (1) Repetitive rating; pulse width limited by max. junction temperature
 (2) Starting $T_J = 25^\circ\text{C}$, $L = 1.0\text{mH}$, $R_G = 25\Omega$
 $I_{AS} = 31\text{A}$

- (3) $I_{SD} \leq 31\text{A}$, $di/dt \leq 340\text{ A}/\mu\text{s}$, $V_{DD} \leq V_{(BR)DSS}$,
 $T_J \leq 150^\circ\text{C}$

- (4) Pulse width $\leq 400\mu\text{s}$; duty cycle $\leq 2\%$

- (5) Standard version only i.e. without optional thermistor

- (6) I_{CES} includes also opposite leg overall leakage

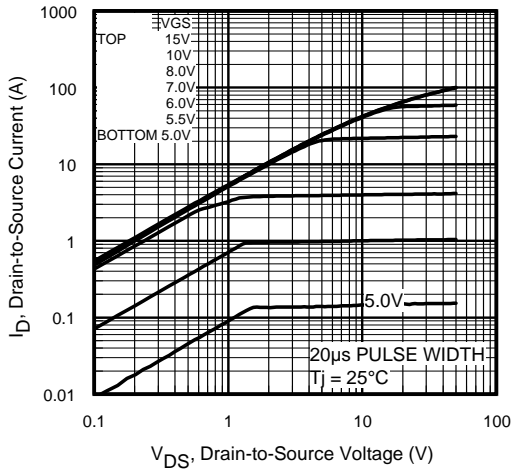

Fig 1. Typical Output Characteristics

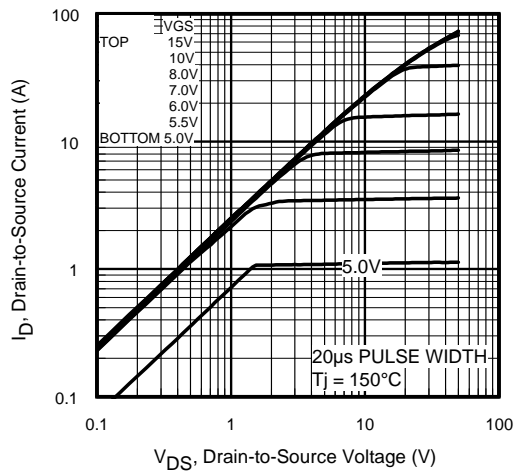

Fig 2. Typical Output Characteristics

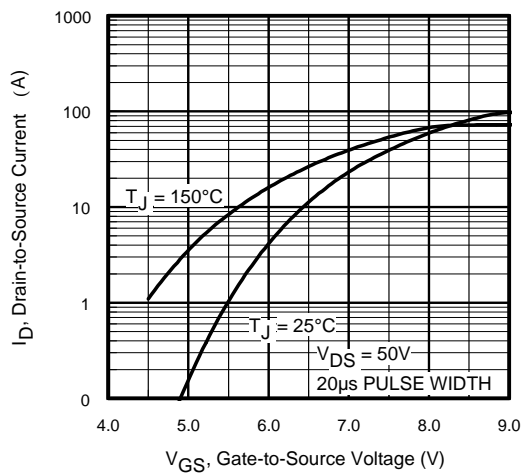

Fig 3. Typical Transfer Characteristics

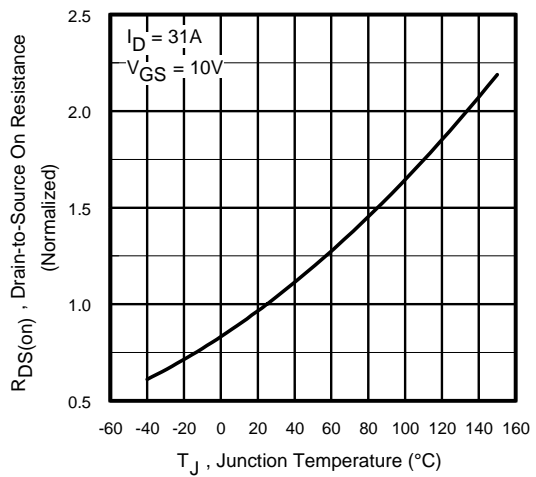

Fig 4. Normalized On-Resistance Vs. Temperature

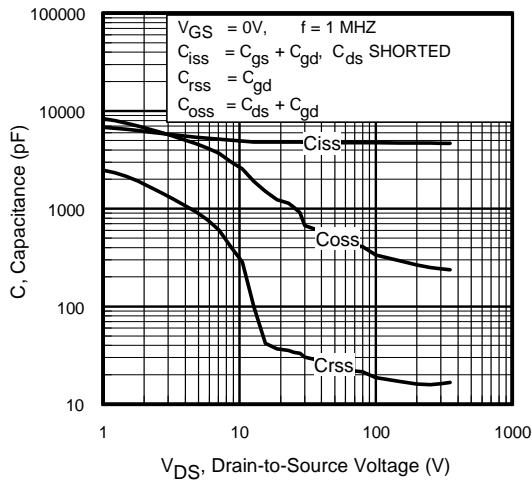

Fig 5. Typical Capacitance Vs. Drain-to-Source Voltage

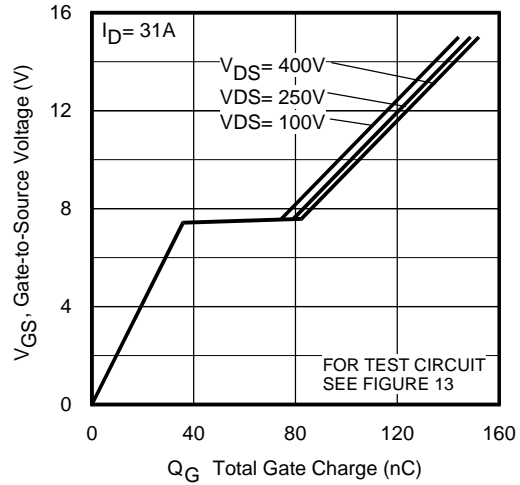

Fig 6. Typical Gate Charge Vs. Gate-to-Source Voltage

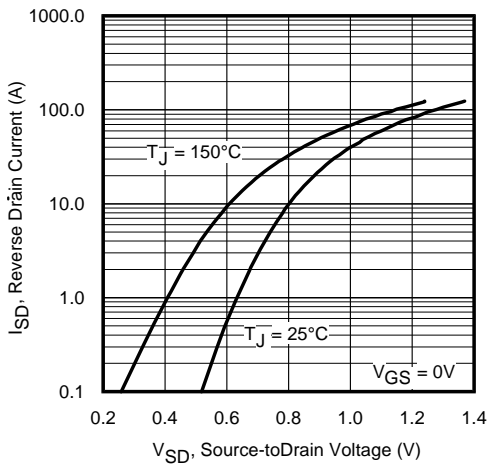

Fig 7. Typical Source-Drain Diode Forward Voltage

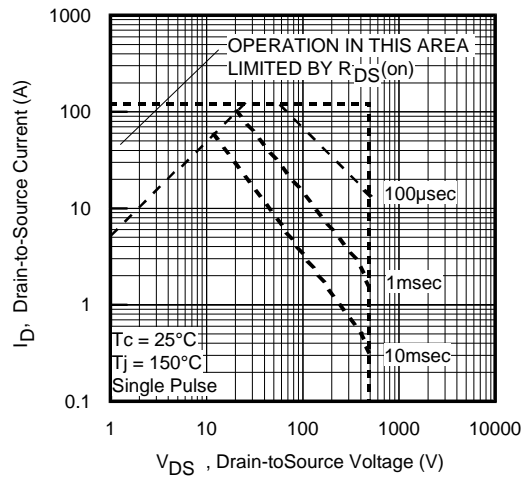

Fig 8. Maximum Safe Operating Area

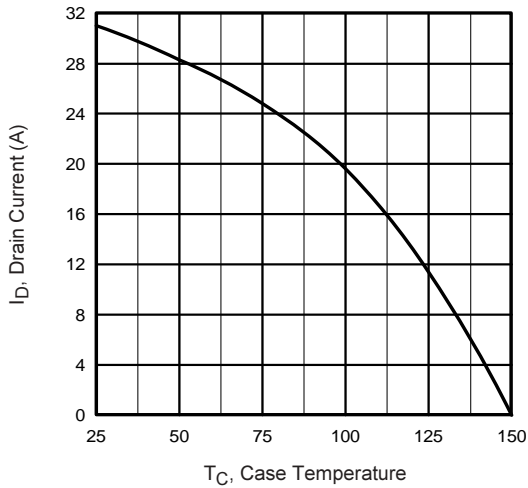

Fig 9. Maximum Drain Current Vs. Case Temperature

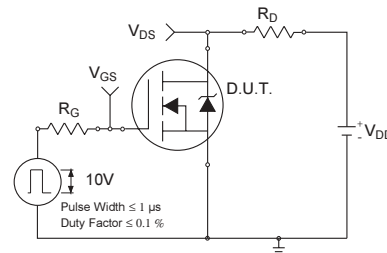

Fig 10a. Switching Time Test Circuit

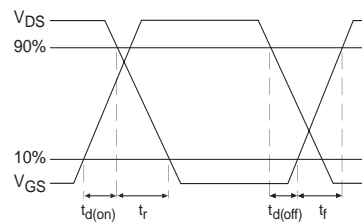

Fig 10b. Switching Time Waveforms

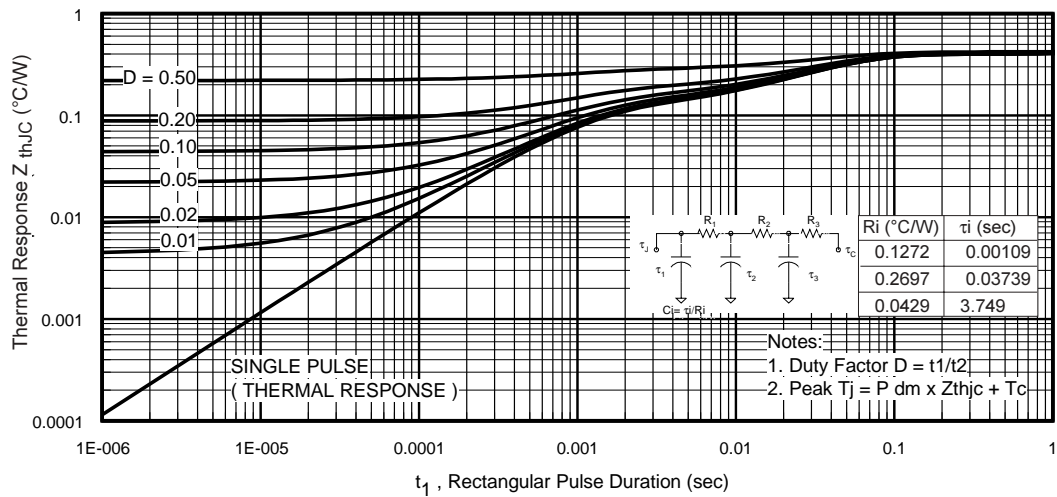

Fig 11. Maximum Effective Transient Thermal Impedance, Junction-to-Case

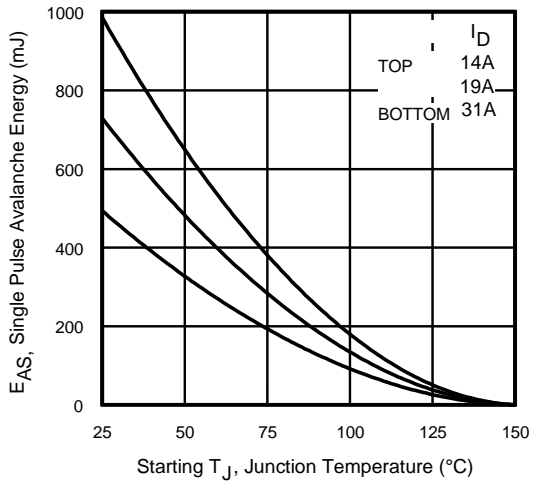

Fig 12a. Maximum Avalanche Energy Vs. Drain Current

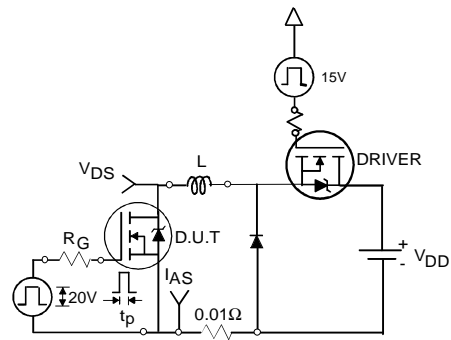

Fig 12b. Unclamped Inductive Test Circuit and vs Junction Temperature

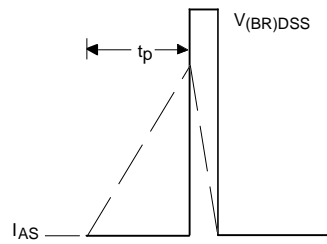

Fig 12c. Unclamped Inductive Waveforms

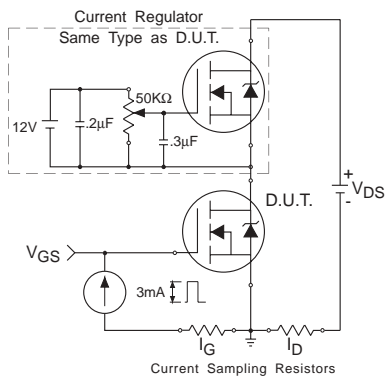

Fig 13a. Gate Charge Test Circuit

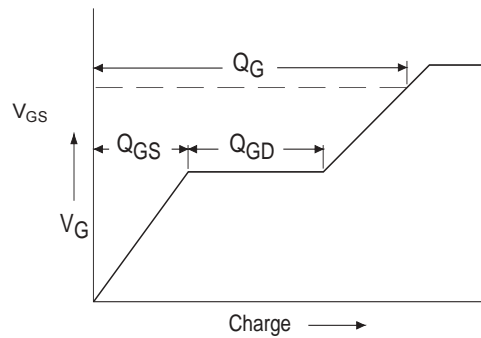
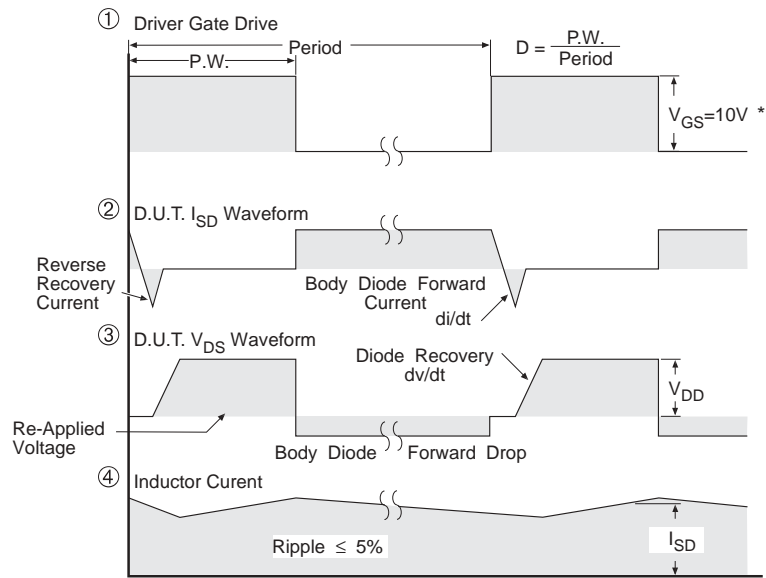
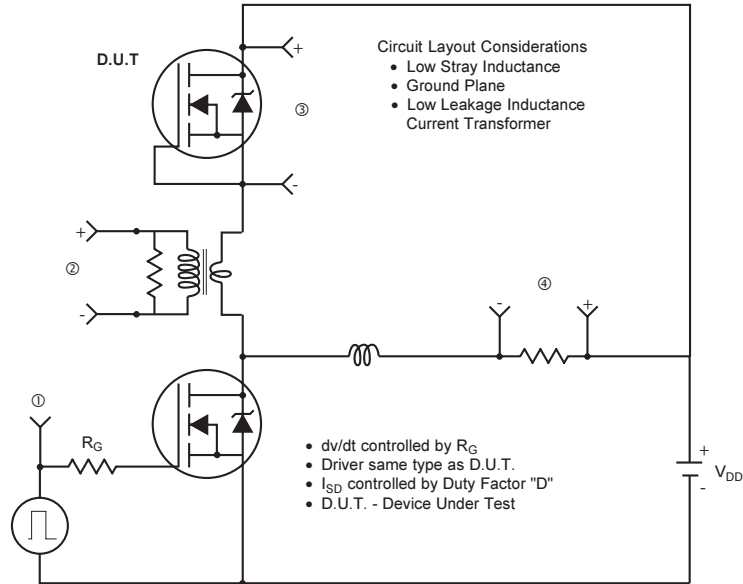

Fig 13b. Basic Gate Charge Waveform

Peak Diode Recovery dv/dt Test Circuit



* $V_{GS} = 5V$ for Logic Level Devices

Fig 14. For N-Channel HEXFET® Power MOSFETs

Outline Table

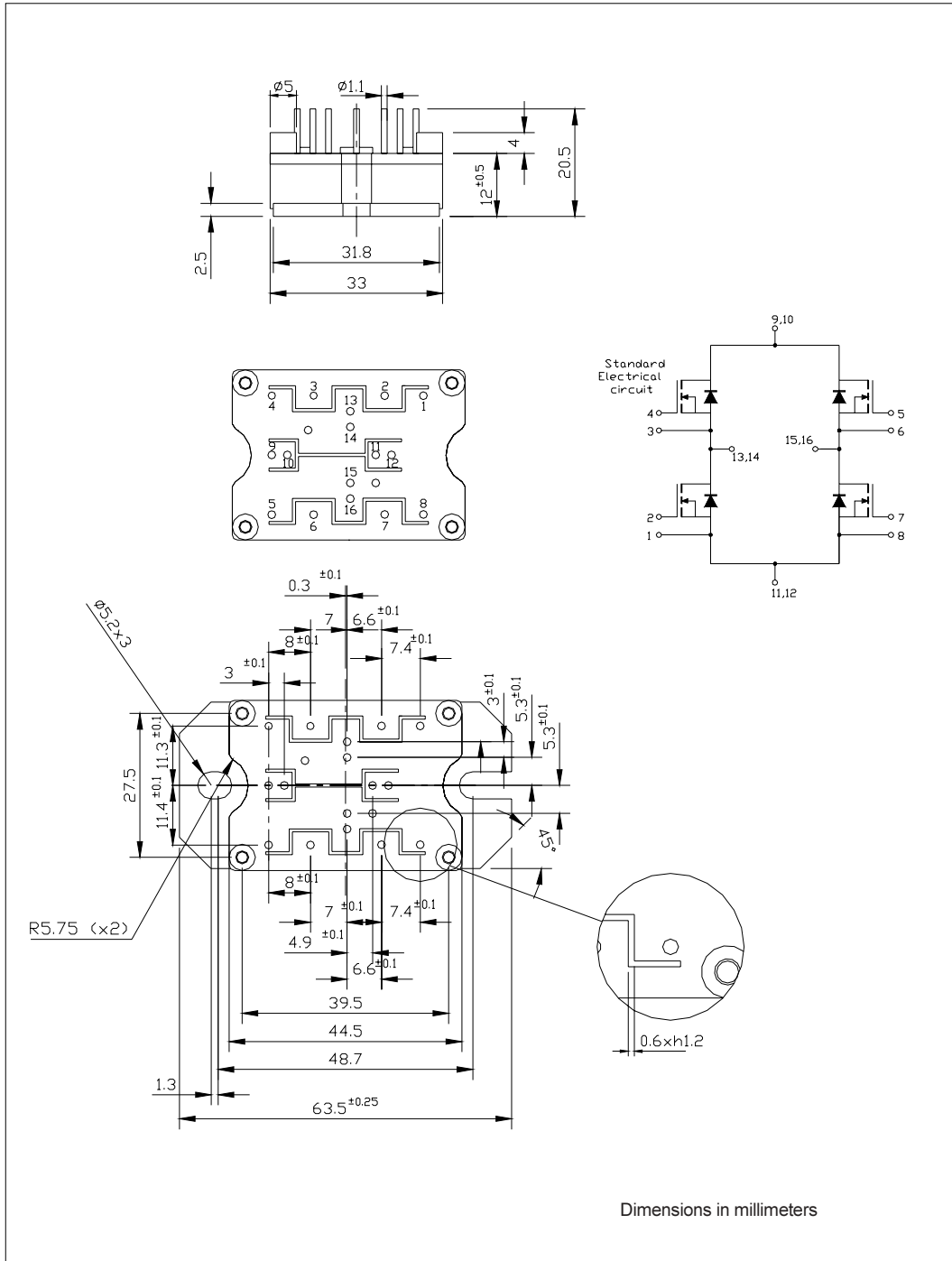

Ordering Information Table

Device Code						
	<table border="1" style="display: inline-table; border-collapse: collapse;"> <tr> <td style="padding: 5px;">19</td> <td style="padding: 5px;">MT</td> <td style="padding: 5px;">050</td> <td style="padding: 5px;">X</td> <td style="padding: 5px;">F</td> </tr> </table>	19	MT	050	X	F
19	MT	050	X	F		
	<table style="display: inline-table; border: none;"> <tr> <td style="text-align: center; border: 1px solid black; border-radius: 50%; width: 20px; height: 20px;">1</td> <td style="text-align: center; border: 1px solid black; border-radius: 50%; width: 20px; height: 20px;">2</td> <td style="text-align: center; border: 1px solid black; border-radius: 50%; width: 20px; height: 20px;">3</td> <td style="text-align: center; border: 1px solid black; border-radius: 50%; width: 20px; height: 20px;">4</td> <td style="text-align: center; border: 1px solid black; border-radius: 50%; width: 20px; height: 20px;">5</td> </tr> </table>	1	2	3	4	5
1	2	3	4	5		
1	- Current rating (19 = 19A)					
2	- Essential Part Number					
3	- Voltage code (050 = 500V)					
4	- Speed/ Type (X = HexFet)					
5	- Circuit Configuration (F = Full Bridge)					

Data and specifications subject to change without notice.
 This product has been designed and qualified for Industrial Level.
 Qualification Standards can be found on IR's Web site.

International
IR Rectifier

IR WORLD HEADQUARTERS: 233 Kansas St., El Segundo, California 90245, USA Tel: (310) 252-7105
 TAC Fax: (310) 252-7309

Visit us at www.irf.com for sales contact information. 09/02