

International  
**IOR** Rectifier

16CTQ...  
 16CTQ...S  
 16CTQ...-1

SCHOTTKY RECTIFIER

16 Amp

#### Major Ratings and Characteristics

Characteristics	Values	Units
$I_{F(AV)}$ Rectangular waveform	16	A
$V_{RRM}$	60/100	V
$I_{FSM}$ @ tp = 5 $\mu$ s sine	850	A
$V_F$ @ 8Apk, $T_J = 125^\circ\text{C}$ (per leg)	0.58	V
$T_J$ range	-55 to 175	$^\circ\text{C}$

#### Description/ Features

This center tap Schottky rectifier series has been optimized for low reverse leakage at high temperature. The proprietary barrier technology allows for reliable operation up to 175°C junction temperature. Typical applications are in switching power supplies, converters, free-wheeling diodes, and reverse battery protection.

- 175° C  $T_J$  operation
- Center tap configuration
- Low forward voltage drop
- High purity, high temperature epoxy encapsulation for enhanced mechanical strength and moisture resistance
- High frequency operation
- Guard ring for enhanced ruggedness and long term reliability

#### Case Styles

16CTQ...	16CTQ...S	16CTQ...-1
		
TO-220	D <sup>2</sup> PAK	TO-262

## Voltage Ratings

Parameters	16CTQ060 16CTQ060S 16CTQ060-1	16CTQ80 16CTQ80S 16CTQ80-1	16CTQ100 16CTQ100S 16CTQ100-1
$V_R$ Max. DC Reverse Voltage (V)	60	80	100
$V_{RWM}$ Max. Working Peak Reverse Voltage (V)			

## Absolute Maximum Ratings

Parameters	Values	Units	Conditions
$I_{F(AV)}$ Max. Average Forward Current (Per Leg) * See Fig. 5 (Per Device)	8	A	50% duty cycle @ $T_C = 148^\circ\text{C}$ , rectangular wave form
	16		
$I_{FSM}$ Max. Peak One Cycle Non-Repetitive Surge Current (Per Leg) * See Fig. 7	850	A	5 $\mu\text{s}$ Sine or 3 $\mu\text{s}$ Rect. pulse 10ms Sine or 6ms Rect. pulse
	275		
$E_{AS}$ Non-Repetitive Avalanche Energy (Per Leg)	7.50	mJ	$T_J = 25^\circ\text{C}$ , $I_{AS} = 0.50$ Amps, $L = 60$ mH
$I_{AR}$ Repetitive Avalanche Current (Per Leg)	0.50	A	Current decaying linearly to zero in 1 $\mu\text{sec}$ Frequency limited by $T_J$ max. $V_A = 1.5 \times V_R$ typical

## Electrical Specifications

Parameters	Values	Units	Conditions
$V_{FM}$ Max. Forward Voltage Drop (Per Leg) * See Fig. 1 (1)	0.72	V	@ 8A $T_J = 25^\circ\text{C}$
	0.88	V	@ 16A
	0.58	V	@ 8A $T_J = 125^\circ\text{C}$
	0.69	V	@ 16A
$I_{RM}$ Max. Reverse Leakage Current (Per Leg) * See Fig. 2 (1)	0.55	mA	$T_J = 25^\circ\text{C}$
	7.0	mA	$T_J = 125^\circ\text{C}$ $V_R = \text{rated } V_R$
$V_{F(TO)}$ Threshold Voltage	0.415	V	$T_J = T_J \text{ max.}$
$r_t$ Forward Slope Resistance	11.07	m $\Omega$	
$C_T$ Max. Junction Capacitance (Per Leg)	500	pF	$V_R = 5V_{DC}$ , (test signal range 100Khz to 1Mhz) $25^\circ\text{C}$
$L_S$ Typical Series Inductance (Per Leg)	8.0	nH	Measured lead to lead 5mm from package body
dv/dt Max. Voltage Rate of Change (Rated $V_R$ )	10,000	V/ $\mu\text{s}$	

(1) Pulse Width < 300 $\mu\text{s}$ , Duty Cycle < 2%

## Thermal-Mechanical Specifications

Parameters	Values	Units	Conditions
$T_J$ Max. Junction Temperature Range	-55 to 175	$^\circ\text{C}$	
$T_{stg}$ Max. Storage Temperature Range	-55 to 175	$^\circ\text{C}$	
$R_{thJC}$ Max. Thermal Resistance Junction to Case (Per Leg)	3.25	$^\circ\text{C/W}$	DC operation
$R_{thJC}$ Max. Thermal Resistance Junction to Case (Per Package)	1.63	$^\circ\text{C/W}$	DC operation
$R_{thCS}$ Typical Thermal Resistance, Case to Heatsink	0.50	$^\circ\text{C/W}$	Mounting surface, smooth and greased (only for TO-220)
wt Approximate Weight	2(0.07)	g(oz.)	
T Mounting Torque	Min.	6(5)	Kg-cm (lbf-in)
	Max.	12(10)	

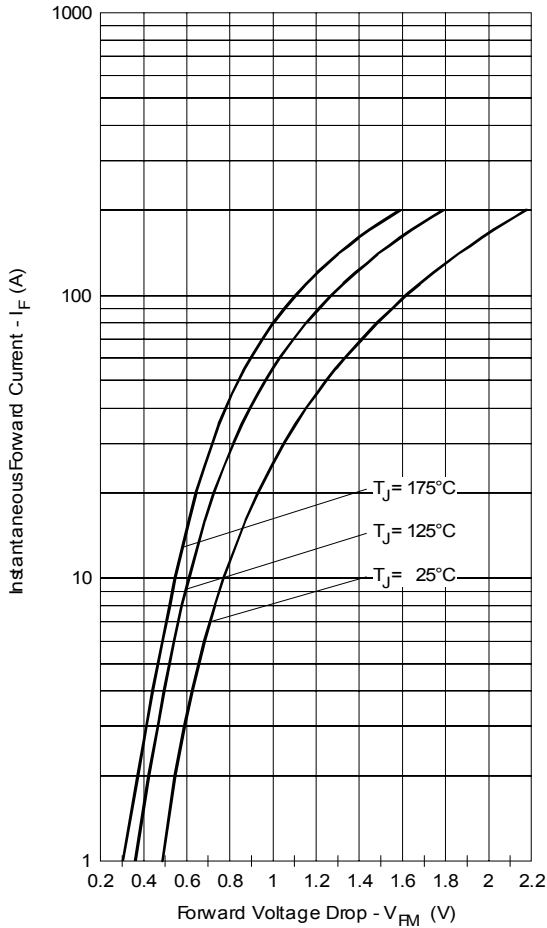

Fig. 1- Max. Forward Voltage Drop Characteristics (PerLeg)

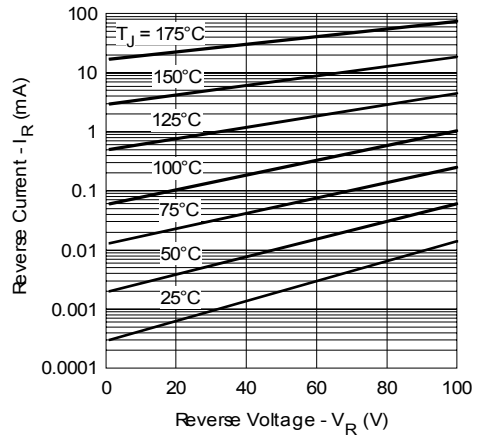

Fig. 2- Typical Values Of Reverse Current Vs. Reverse Voltage (PerLeg)

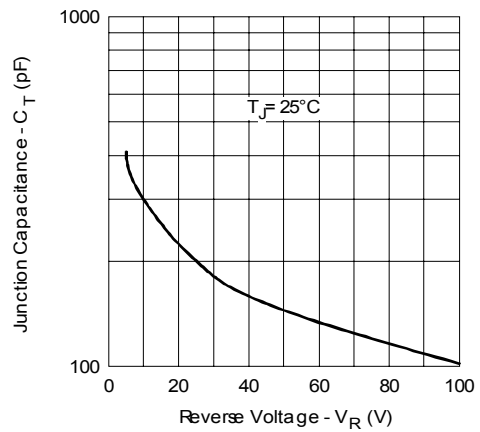

Fig. 3- Typical Junction Capacitance Vs. Reverse Voltage (PerLeg)

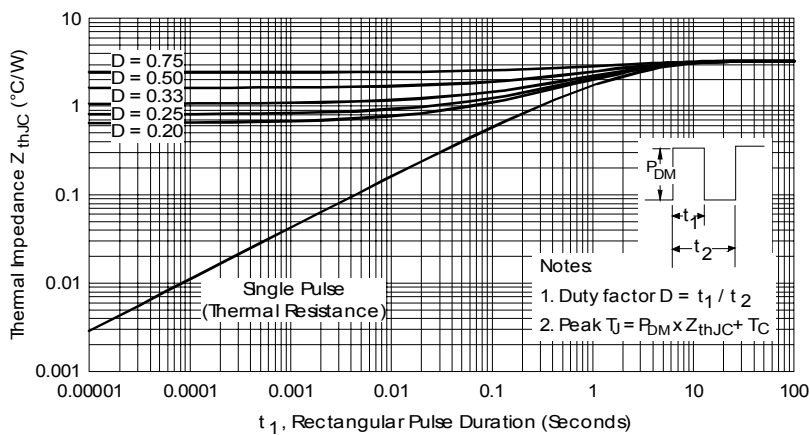

Fig. 4- Max. Thermal Impedance  $Z_{thJC}$  Characteristics (PerLeg)

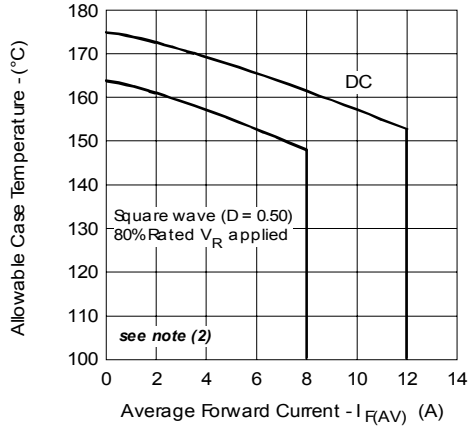

Fig. 5- Max. Allowable Case Temperature Vs. Average Forward Current (PerLeg)

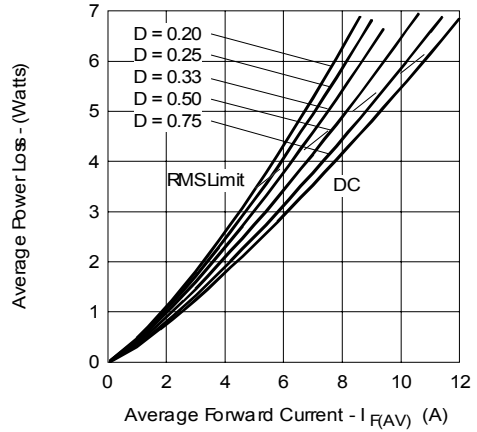

Fig. 6- Forward Power Loss Characteristics (PerLeg)

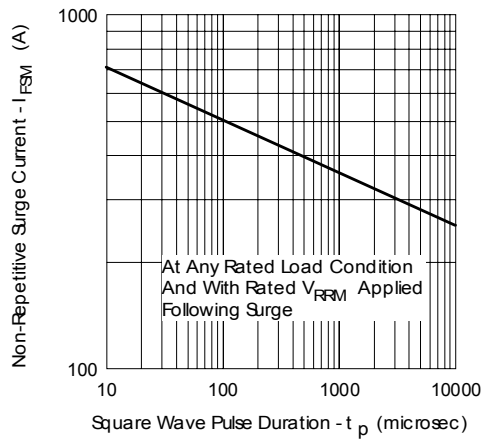

Fig. 7- Max. Non-Repetitive Surge Current (PerLeg)

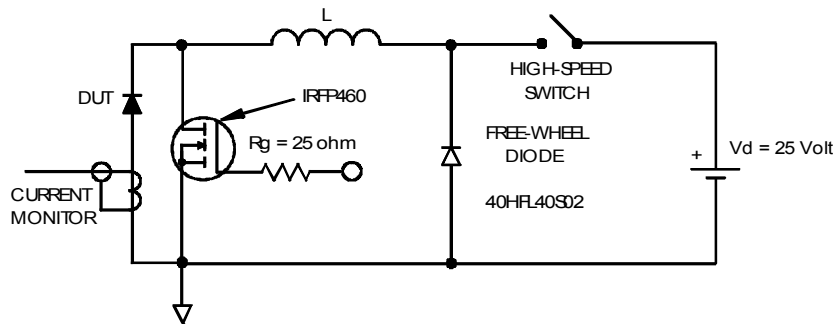

Fig. 8- Unclamped Inductive Test Circuit

(2) Formula used:  $T_c = T_j - (Pd + Pd_{REV}) \times R_{thJC}$ ;

$Pd$  = Forward Power Loss =  $I_{F(AV)} \times V_{FM} @ (I_{F(AV)} / D)$  (see Fig. 6);

$Pd_{REV}$  = Inverse Power Loss =  $V_{R1} \times I_R (1 - D)$ ;  $I_R @ V_{R1} = 10V$

Outline Table

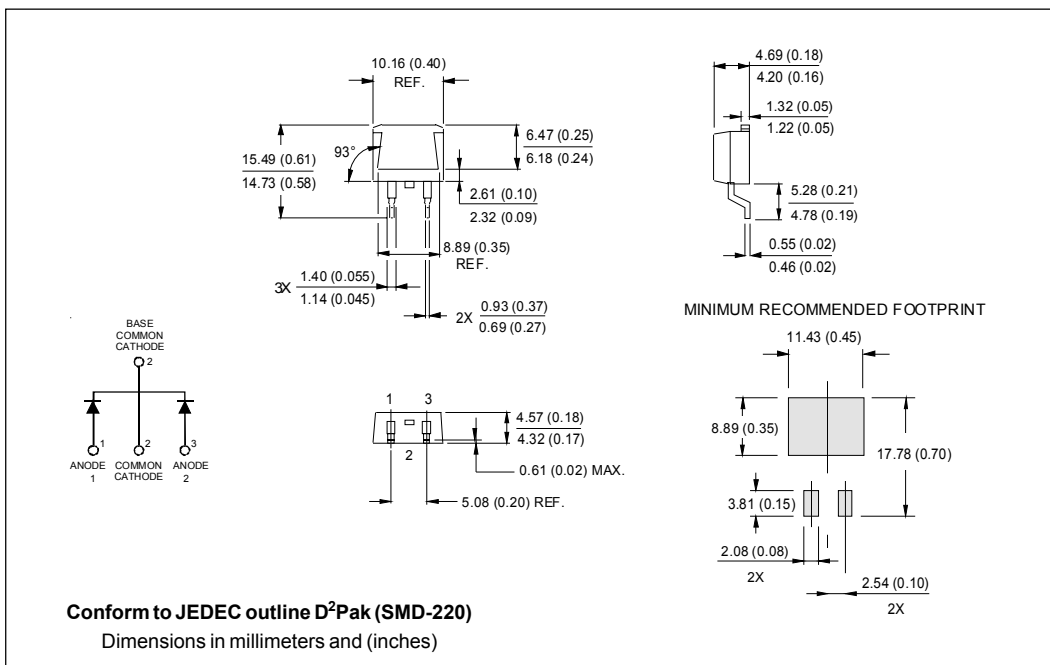
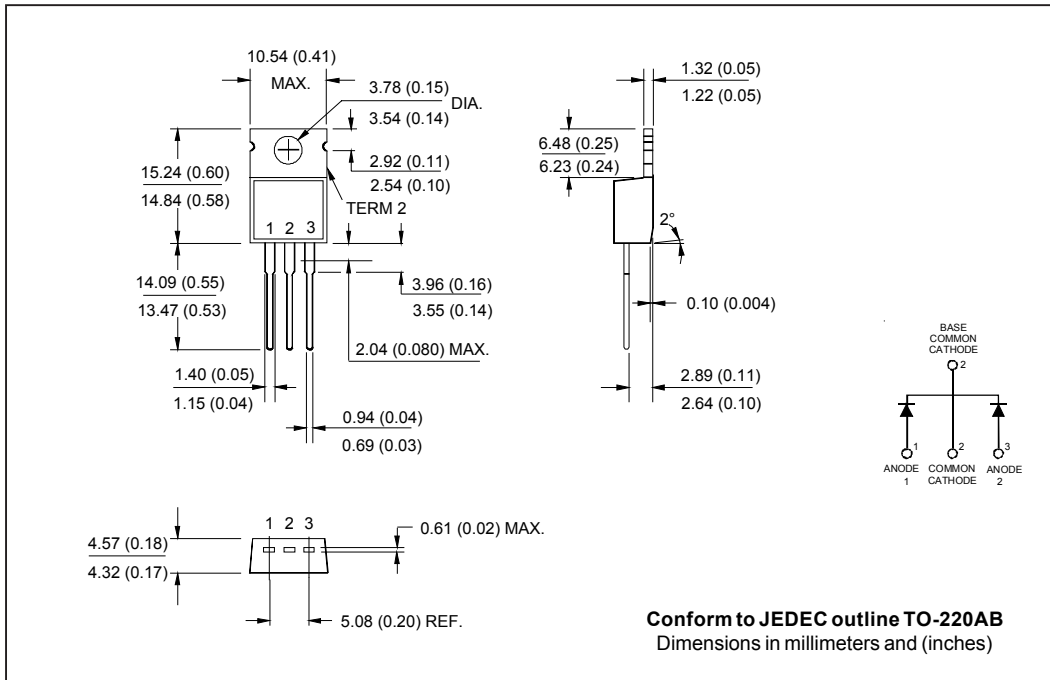

Outline Table

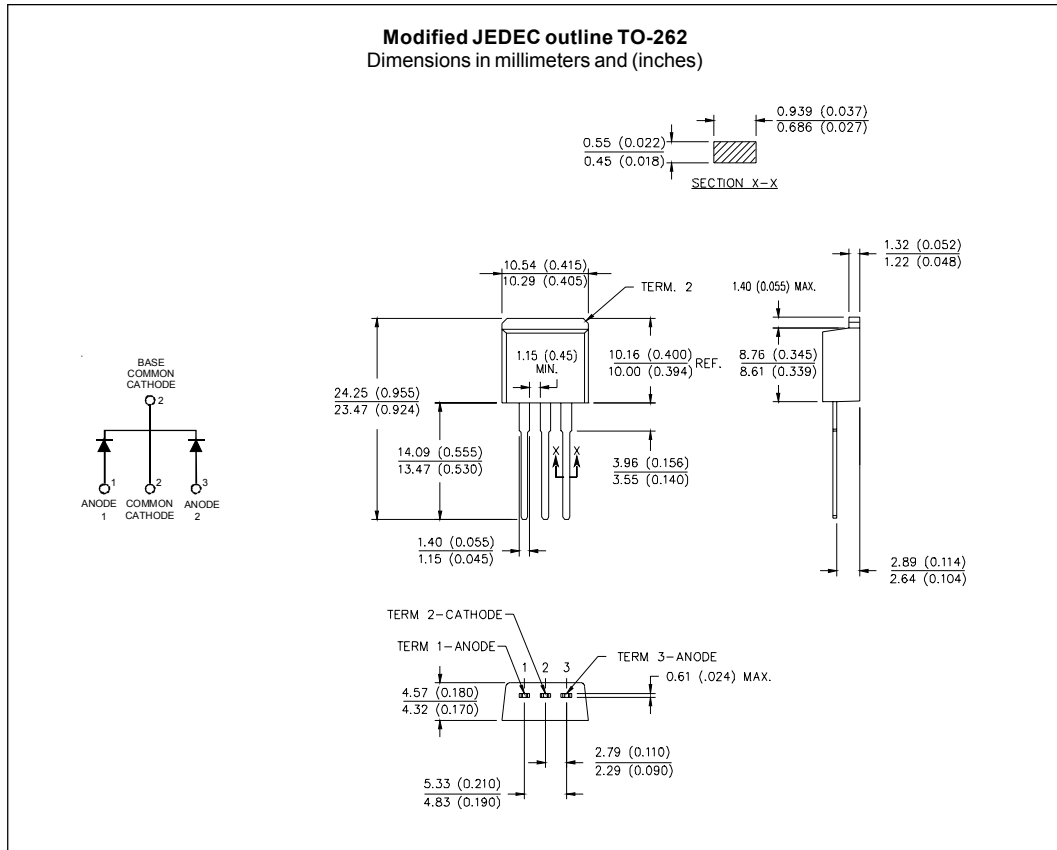

Marking Information

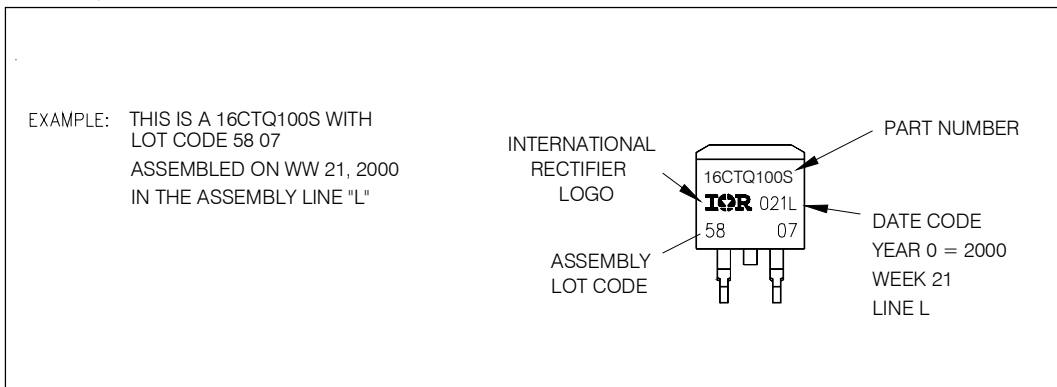

Tape & Reel Information

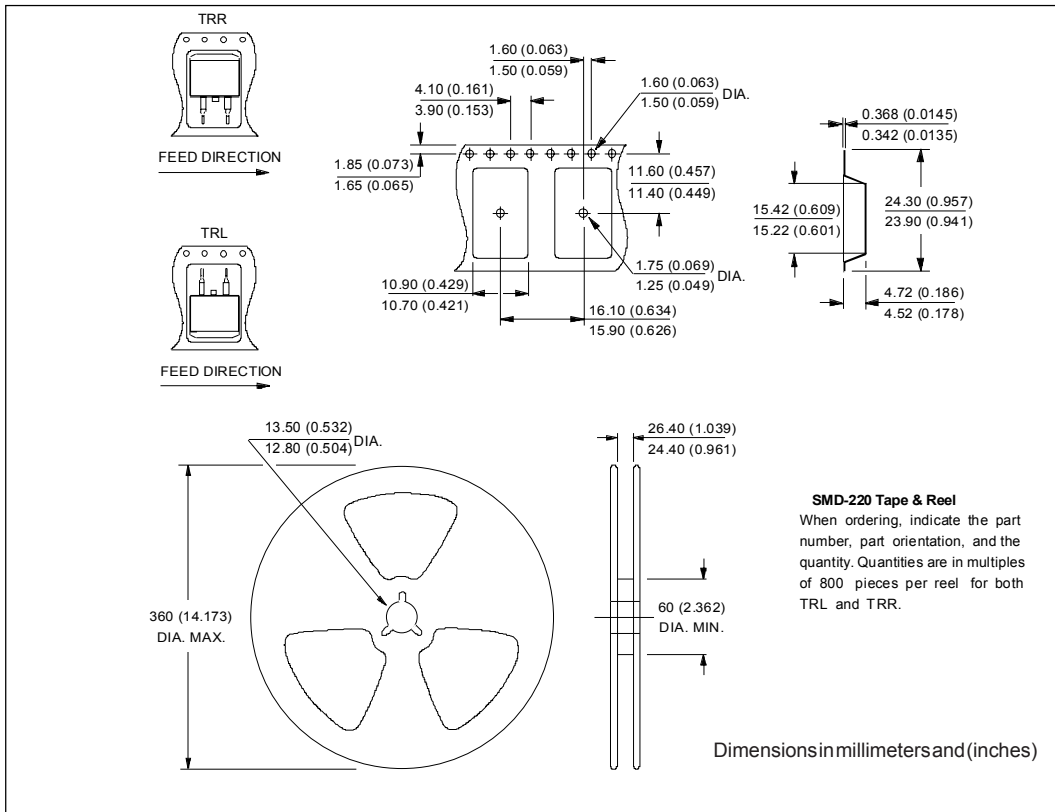

Ordering Information Table

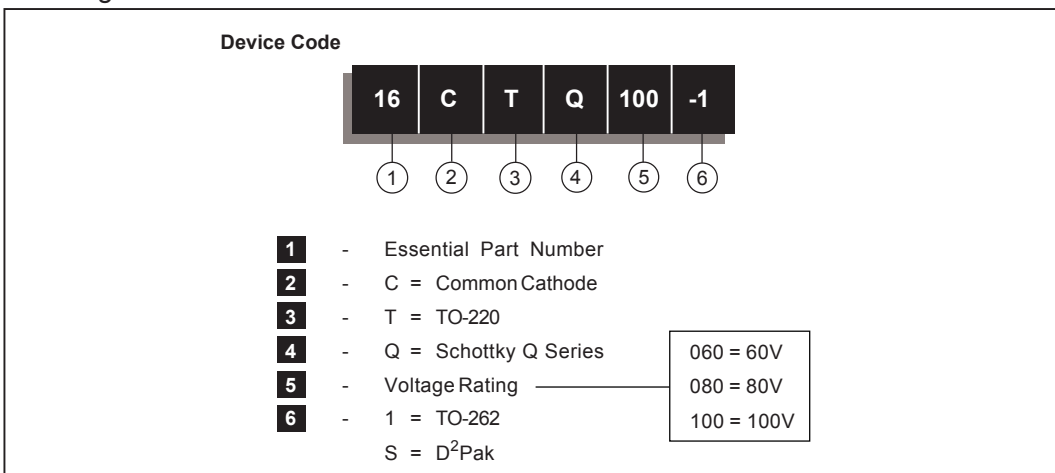

```

16CTQ100
*****
* SPICE Model Diode *
*****
.SUBCKT 16CTQ100 ANO CAT
D1 ANO 1 DMOD (0.07089)
*Define diode model
.MODEL DMOD D(IS=21.21E-06,N=1.578,Rs=7.804E-03,Ikf=0.9497,Xti=2,Eg=1.11
+ Cjo=1.278E-09,M=0.4736,Vj=0.4972,Fc=0.5,Irs=1.114e-21,Nr=4.755,
+ Bv=119.9,Ibv=215.5E-06,Tt=18.2E-09)
*****

.ENDS 16CTQ100

Thermal Model Subcircuit
.SUBCKT 16CTQ100 5 1

CTHERM1      5      4      1.45E+00
CTHERM2      4      3      4.54E+00
CTHERM3      3      2      1.09E+01
CTHERM4      2      1      1.01E+02

RTHERM1      5      4      2.49E+00
RTHERM2      4      3      5.20E-04
RTHERM1      3      2      5.43E-01
RTHERM1      2      1      3.05E-02

.ENDS 16CTQ100

```

Data and specifications subject to change without notice.  
This product has been designed and qualified for Industrial Level.  
Qualification Standards can be found on IR's Web site.

International  
**IR** Rectifier

**IR WORLD HEADQUARTERS:** 233 Kansas St., El Segundo, California 90245, USA Tel: (310) 252-7105  
TAC Fax: (310) 252-7309  
Visit us at [www.irf.com](http://www.irf.com) for sales contact information. 12/03